

# CEAR



## MOTORI ELETTRICI A CORRENTE CONTINUA PER APPLICAZIONI INDUSTRIALI

## DIRECT CURRENT ELECTRIC MOTORS FOR INDUSTRIAL APPLICATIONS

### SERIE MGL NON COMPENSATI

GRANDEZZE 80 - 100 (2 POLI)  
GRANDEZZA 112 - 160 (4 POLI)

POTENZE DA 1,6 A 73 KW (a 1500 rpm)  
COPPIE DA 10 A 460 Nm

### MGL SERIES UNCOMPENSATED

SIZE 80 - 100 (2 POLES)  
SIZE 112 - 160 (4 POLES)

POWER FROM 1.6 TO 73 KW (at 1500 rpm)  
TORQUE FROM 10 TO 460 Nm





## MOTORI ELETTRICI A CORRENTE CONTINUA DIRECT CURRENT ELECTRIC MOTORS

<b>Indice</b>	<b>Index</b>	
Produzione CEAR.....	CEAR production.....	Pag. 3
Isolamento.....	Insulation.....	Pag. 4
Rappresentazione grafica.....	Graphical representation.....	Pag. 5
Lista componenti.....	Parts list.....	Pag. 6
Forme costruttive.....	Construction form.....	Pag. 7
Metodi di raffreddamento.....	Methods of cooling.....	Pag. 9
Tipi di servizio.....	Duty types.....	Pag. 11
Caratteristiche generali.....	General characteristics.....	Pag. 15
Grafici selezione motori.....	Graphics motor selection.....	Pag. 16
Motori taglia MGL 80.....	Motors size MGL 80 .....	Pag. 18
Motori taglia MGL 100 .....	Motors size MGL 100.....	Pag. 30
Disegni d'ingombro MGL 80-100.....	Motors dimensions MGL 80-100.....	Pag. 45
Motori taglia MGL 112 .....	Motors size MGL 112.....	Pag. 46
Motori taglia MGL 132 .....	Motors size MGL 132 .....	Pag. 58
Motori taglia MGL 160.....	Motors size MGL 160.....	Pag. 70
Disegni d'ingombro MGL 112-132-160.....	Motors dimensions MGL 112-132-160.....	Pag. 91
Tolleranze su quote di accoppiamento.....	Tolerances of connecting dimensions.....	Pag. 92
Tolleranze su quote di accoppiamento.....	Tolerances of connecting dimensions.....	Pag. 93
Piazzamento-Quote ausiliarie.....	Placement-Auxiliary dimension.....	Pag. 94
Tabella quote per bocchette di ventilazione separata.....	Dimensions table of adapted openings for..... separated ventilation	Pag. 95
Richiesta di assistenza e parti..... di ricambio	Inquiry of assistance and spare parts.....	Pag. 96



## MOTORI ELETTRICI A CORRENTE CONTINUA DIRECT CURRENT ELECTRIC MOTORS

### **PRODUZIONE CEAR**

Tutte le macchine costruite dalla ditta CEAR sono conformi alle norme CEI EN 60034-1 classificazione 2-3 fascicolo n°11111 (data di pubblicazione 2011), per le macchine elettriche rotanti ed alle raccomandazioni internazionali IEC.

Il collaudo viene eseguito su ogni macchina, secondo quanto stabilito dalle suddette norme, onde accertarne il corretto funzionamento.

Sono inoltre considerate esecuzioni rispondenti a particolari esigenze delle ditte committenti nel rispetto di eventuali normative estere e della buona regola d'arte.

### **CEAR PRODUCTION**

All motors made by company CEAR are in accordance with the norms CEI EN 60034-1 classification 2-3 fasc. n°11111 (publication date 2011), for the electrical rotating machines and with the IEC international recommendations.

Every motor is tested as established from the above mentioned norms in order to verify the correct operation.

We are at complete disposal for eventual execution of motors answering to particular needs of our customers ever in the respect of eventual foreign norms and executed to art rule.



## **ISOLAMENTO**

I motori della serie MGL e MGLC sono costruiti utilizzando materiali con isolamento in classe H.  
La sovratemperatura ammessa per la classe H dalle norme CEI EN 60034-1 classificazione 2-3 fascicolo n°11111 (data pubblicazione 2011), è pari a  $\Delta T = 125^\circ\text{C}$ .

I motori indicati sul catalogo sono previsti per sovratureperature, relative alla classe F, pari a  $\Delta T = 105^\circ\text{C}$ .

I motori vengono perciò utilizzati per una sovratemperatura inferiore mediamente del 20% offrendo così un più elevato grado di affidabilità.

## **INSULATION**

Motors of series MGL and MGLC are constructed using material with insulation class H.  
The overtemperature admitted for the class from the norms CEI EN 60034-1 classification 2-3 fasc. n°11111 (publication date 2001), is like  $\Delta T = 125^\circ\text{C}$ .

Motors indicated on the catalogue are provided for overtemperature of class F, like to  $\Delta T = 105^\circ\text{C}$ .

Motors are therefore used for a lower overtemperature of 20% on average, offering an higher reliability level.



**Motori Serie MGL**  
**Motoren Serie MGL**  
**Motor Series MGL**

Tabella / Tisch / Tables  
N° 3

Foglio / Seite / Sheet  
N° 1

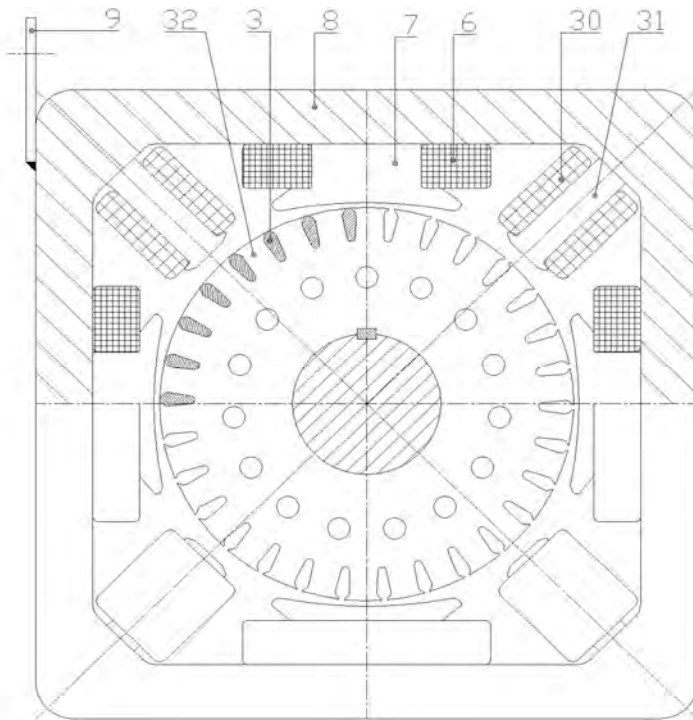

RAPPRESENTAZIONE GRAFICA  
MOTORE SERIE MGL

DRAWINGS  
MOTOR SERIAL MGL

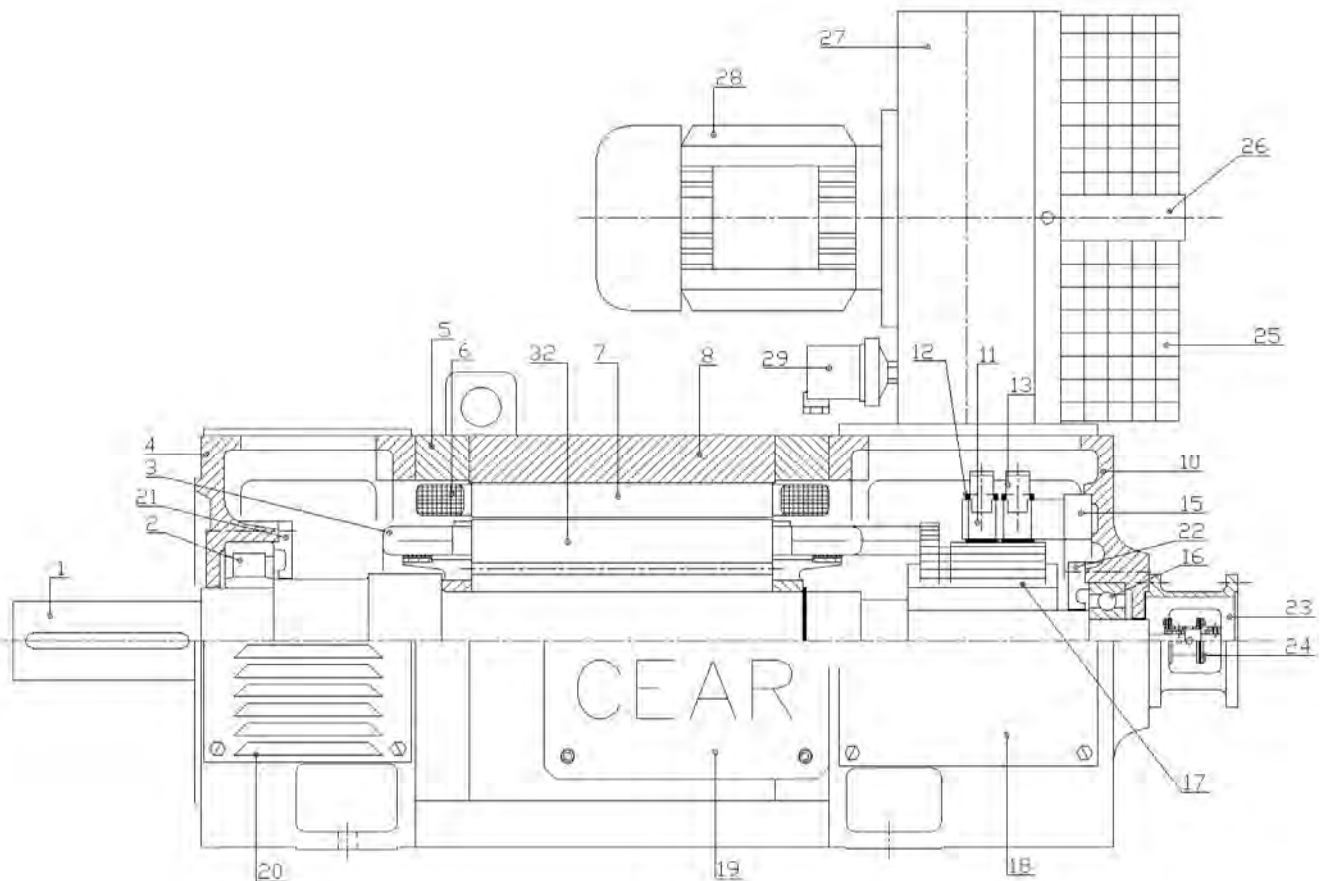



**Motori Serie MGL  
Motoren Serie MGL  
Motor Series MGL**

Tabella / Tisch / Tables  
N° 3

Foglio / Seite / Sheet  
N° 2

**LISTA COMPONENTI**





**MOTORE SERIE MGL**

**PARTS LISTS**

**MOTOR SERIAL MGL**

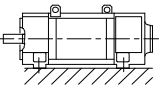
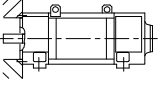
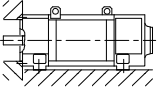
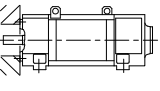
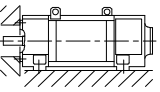
1	Sporgenza d'albero .....	Shaft end
2	Cuscinetto lato accoppiamento .....	Bearing coupling side
3	Avvolgimento del rotore .....	Engine winding up
4	Scudo lato accoppiamento .....	Coupling shield side
5	Viti di fissaggio scudi - statore .....	Fixing screws shield-box
6	Bobina poli principali .....	Coil mains poles
7	Nucleo poli principali .....	Nucleous mains poles
8	Statore Lamellare .....	Blades package stator
9	Golfari di sollevamento .....	Lifting ring
10	Scudo lato opposto .....	Opposite shield side
11	Cassetto portaspazzole e spazzole .....	Drawer brushes-holder
12	Spazzole .....	Brushes
13	Molle spingi spazzole .....	Spring
15	Anello portaspazzole .....	Brushes-holder ring
16	Cuscinetto lato opposto .....	Bearing opposite side
17	Collettore .....	Collector
18	Portello ispezione lato opposto .....	Opposite side inspection door
19	Scatola Morsettiera .....	Terminal board
20	Portello lato accoppiamento .....	Coupling side door
21	Coperchietto interno lato accopp. ....	Coupling side interior small-cover
22	Coperchietto interno lato opposto .....	Opposite side interior small-cover
23	Lanterna attacco D.T. ....	Lantern for Tachogenerator
24	Giunto elastico di adattamento D.T. ....	Elastic Joint for tachogenerator
25	Filtro Ventilatore .....	Ventilator filter
26	Staffe di sostegno filtro .....	Support filter stirrups
27	Voluta ventiatore .....	Ventilator carter
28	Motore ventilatore .....	Ventilator engine
29	Relè anemostatico .....	Air flow control relay
30	Bobina poli ausiliari .....	Auxiliarys poles bobbin
31	Nucleo poli ausiliari .....	Nucleus auxiliarys poles
32	Pacco rotore .....	Rotor package



Figura Sketch	CEI EN 60034-7		UNEL 05513	
	Cod. II	Cod. I		
	IM 1001	IM B3	B3	Fissata mediante piedi; piedi disposti verso il basso Mounted by feet, feet down
	IM 3001	IM B5	B5	Fissata sul lato della flangia con fori passanti, rivolto verso il lato comando Mounted by on D-end side of flange
	IM 2001	IM B35	B3/B5	Fissata mediante piedi disposti verso il basso; fissaggio ulteriore sul lato della flangia con fori passanti rivolto verso il lato comando Mounted by feet, feet down, with additional mounting on D-end side of flange
	IM 3601	IM B14	B14	Fissata sul lato della flangia con fori filettati, rivolto verso il lato comando Mounted by on D-end side of flange with tapped holes
	IM 2101	IM B34	B3/B14	Fissata mediante piedi, piedi disposti verso il basso. Fissaggio ulteriore sul lato della flangia con fori filettati rivolto verso il lato comando. Mounted by feet, feet down, with additional mounting on D-end side of flange with tapped holes
	IM 1051	IM B6	B6	Fissata mediante piedi; piedi a sinistra (visti dal lato comando) Mounted by feet, feet left (viewed from D-end)
	IM 1061	IM B7	B7	Fissata mediante piedi; piedi a destra (visti dal lato comando) Mounted by feet, feet right (viewed from D-end)
	IM 1070	IM B8	B8	Fissata mediante piedi; piedi disposti verso l'alto Mounted by feet, feet up



Forme costruttive  
Construction Forms

18.05.2007  
Sheet N° 10

Macchine ad asse verticale  
Machines with vertical shaft

Tables N° 05

Figura Sketch	CEI EN 60034-7		UNEL 05513	
	Cod. II	Cod. I		
	IM 1011	IM V5	V5	Fissata mediante piedi; lato comando in basso Mounted by feet, D-end down
	IM 1031	IM V6	V6	Fissata mediante piedi; lato comando in alto Mounted by feet, D-end up
	IM 3031	IM V3	V3	Fissata sul lato della flangia con fori passanti rivolto verso il lato comando, lato comando in alto Mounted on D-end side of flange, D-end up
	IM 3011	IM V1	V1	Fissata sul lato della flangia con fori passanti, rivolto verso il lato comando, lato comando in basso Mounted on D-end side of flange, D-end down
	IM 2031	IM V36	V3/V6	Fissata mediante piedi; fissaggio ulteriore sulla flangia con fori passanti dal lato comando; lato comando in alto Mounted by feet, feet down, with additional mounting on D-end side of flange, D-end up
	IM 2011	IM V15	V1/V5	Fissata mediante piedi; fissaggio ulteriore sulla flangia con fori passanti dal lato comando; lato comando in basso Mounted by feet, feet down, with additional mounting on D-end side of flange, D-end down
	IM 3611	IM V18	V18	Fissata sul lato della flangia con fori filettati, dal lato comando, lato comando in basso Mounted by on D-end side of flange with tapped holes, D-end down
	IM 3631	IM V19	V19	Fissata sul lato della flangia con fori filettati, dal lato comando, lato comando in alto Mounted by on D-end side of flange with tapped holes, D-end up





Figura Sketch	CEI EN 60034-6 Semplificata Simplified	CEI EN 60034-6 Completo Complete	Descrizione Description	CEI EN 60034-5 Grado di Protezione Degrees of Protection
	IC 0 0	IC 0 A 0	Macchina raffreddata naturalmente Free convection	
	IC 0 1	IC 0 A 1	Macchina autoventilata Self-circulation	
	IC 1 1	IC 1 A 1	Macchina autoventilata con canale di aspirazione Self-circulation Inlet pipe duct circulated	
	IC 0 6	IC 0 A 6	Macchina raffreddata mediante dispositivo indipendente aspirante montato assialmente sulla macchina Circulation by machine-mounted axial Inlet independent component	IP 23
	IC 0 6	IC 0 A 6	Macchina raffreddata mediante dispositivo indipendente premente montato assialmente sulla macchina Circulation by machine-mounted axial Outlet independent component	
	IC 0 6	IC 0 A 6	Macchina raffreddata mediante dispositivo indipendente montato sulla macchina Circulation by machine-mounted independent component	
	IC 1 6	IC 1 A 6	Macchina raffreddata mediante dispositivo indipendente montato sulla macchina con canale di aspirazione Circulation by machine-mounted independent component, Inlet pipe duct circulated	
	IC 2 6	IC 2 A 6	Macchina raffreddata mediante dispositivo indipendente montato sulla macchina con canale di scarico Circulation by machine-mounted independent component, Outlet pipe duct circulated	

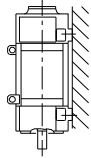
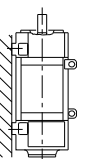
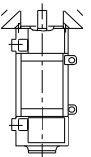
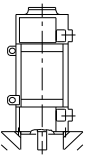
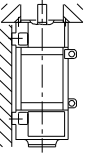
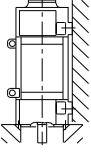
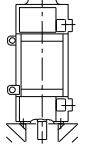
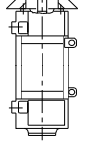

Metodi di Raffreddamento delle macchine elettriche rotanti

Rotating electrical machines, Methods of cooling

19.05.2007  
Sheet N° 01

Tables N° 08

Figura Sketch	CEI EN 60034-6 Semplificata Simplified	CEI EN 60034-6 Completo Complete	Descrizione Description	CEI EN 60034-5 Grado di Protezione Degrees of Protection
	IC 1 7	IC 1 A 7	Macchina raffreddata mediante dispositivo separato e indipendente, mediante pressione della rete di distribuzione  Circulation by separate and independent component, by coolant pressure system	IP 23
	IC 410	IC 4A1A0	Macchina chiusa raffreddata naturalmente  Free-convection	
	IC 416	IC 4A1A6	Macchina chiusa raffreddata superficialmente, mediante dispositivo indipendente montato sulla macchina  Frame surface cooled, circulation by machine-mounted independent component	
	IC 3 6	IC 3 A 6	Macchina raffreddata mediante dispositivo indipendente montato sulla macchina, canali di aspirazione e scarico  Circulation by machine-mounted independent component, Inlet and Outlet pipe duct circulated	
	IC 3 7	IC 3 A 7	Macchina raffreddata mediante dispositivo separato e indipendente, canali di aspirazione e scarico  Circulation by separate and independent component, Inlet and Outlet pipe duct circulated	IP 44
	IC 00 66	IC 6A6A0	Scambiatore di calore montato sulla macchina, circolazione mediante dispositivo indipendente.  Machine-mouted heat exchanger, circulation by independent component	
	IC W37A86	IC 8A6W7	Scambiatore di calore montato sulla macchina, circolazione mediante dispositivo indipendente. Aria-Acqua  Machine-mouted heat exchanger, circulation by independent component. Air-Water cooling	
	IC 06 66	IC 6A6A6	Scambiatore di calore montato sulla macchina, circolazione mediante dispositivo indipendente. Aria-Aria  Machine-mouted heat exchanger, circulation by independent component. Air-Air cooling	



## TIPI DI SERVIZIO E IDENTIFICAZIONE DEL SERVIZIO

Tabella/Tables  
N° 9

## DUTY TYPES AND DECLARATION OF DUTY

Foglio/Sheet  
N° 1

----- Max  
T: Temperature    - - - - - Average  
                              ———— Instantaneous

P: Carico  
load

Pv: Perdite elettriche  
Electrical losses

### Servizio continuo S1

Funzionamento a carico costante di durata sufficiente a consentire alla macchina il raggiungimento dell'equilibrio termico.

L'abbreviazione appropriata è S1.

### Continuous running duty S1

Operation at a constant load maintained for sufficient time to allow the machine to reach thermal equilibrium.

The appropriate abbreviation is S1.

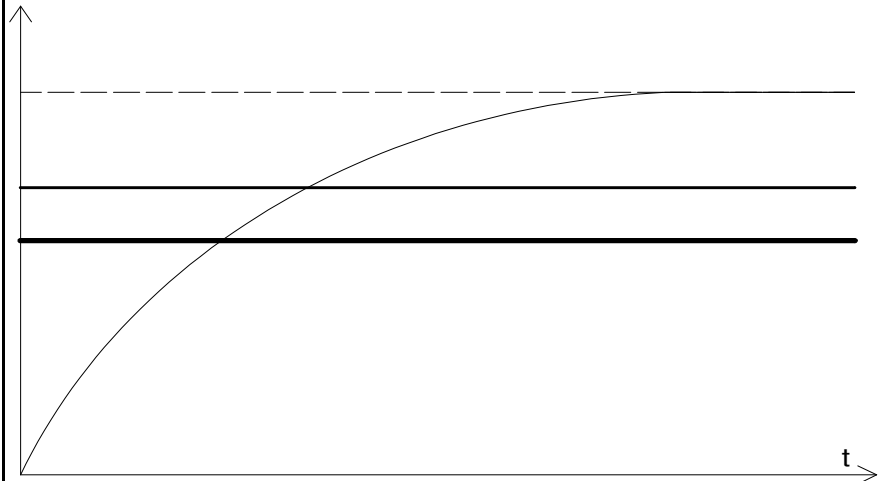

### Servizio di durata limitata S2

Funzionamento a carico costante per un periodo di tempo determinato, inferiore a quello richiesto per raggiungere l'equilibrio termico, seguito da un tempo di riposo di durata sufficiente a ristabilire l'uguaglianza fra la temperatura della macchina e quella del fluido di raffreddamento, con una tolleranza di 2 K.

L'abbreviazione appropriata è S2, seguita dall'indicazione della durata del servizio.

### Short - time duty S2

Operation at constant load for a given time, less than that required to reach thermal equilibrium, followed by a time de-energized and at rest of sufficient duration to re-establish machine temperatures within 2 K of the coolant temperature.

The appropriate abbreviation is S2, followed by an indication of the duration of the duty.

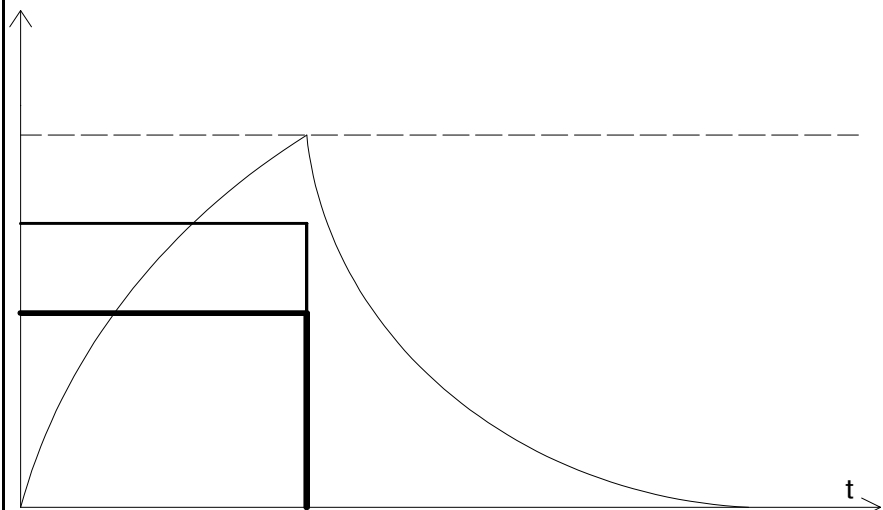

### Servizio intermittente periodico S3<sup>(1)</sup>

Sequenza di cicli di funzionamento identici, ciascuno comprendente un tempo di funzionamento a carico costante ed un tempo di riposo. In questo servizio il ciclo è tale che la corrente di avviamento non influenza la sovratemperatura in maniera significativa. L'abbreviazione appropriata è S3, seguita dall'indicazione del rapporto di intermittenza Ri.

### Intermittent periodic duty S3<sup>(1)</sup>

A sequence of identical duty cycles, each including a time of operation at constant load and a time de-energized and at rest. In this duty, the cycle is such that the starting current does not significantly affect the temperature rise.

The appropriate abbreviation is S3, followed by the cyclic duration factor Ri.

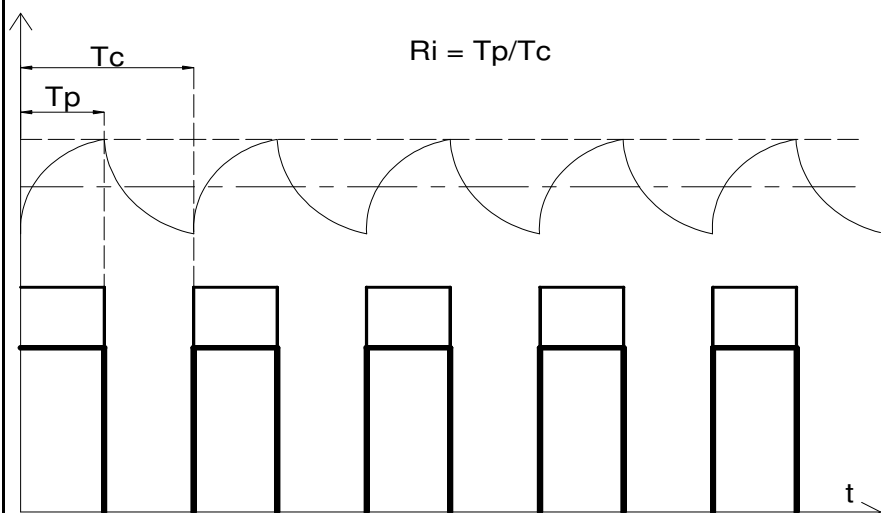

(1) Il servizio periodico implica che l'equilibrio termico non è raggiunto durante il periodo a carico.

(1) Periodic duty implies that thermal equilibrium is not reached during the time on load.



## TIPI DI SERVIZIO E IDENTIFICAZIONE DEL SERVIZIO

Tabella/Tables  
N° 9

## DUTY TYPES AND DECLARATION OF DUTY

Foglio/Sheet  
N° 2

----- Max  
T: Temperature    - - - - - Average  
————— Instantaneous

P: Carico  
load

Pv: Perdite elettriche  
Electrical losses

**Servizio intermittente periodico con avviamento S4<sup>(1)</sup>**  
Sequenza di cicli di funzionamento identici, ciascuno comprendente un tempo non trascurabile di avviamento, un tempo di funzionamento a carico costante ed un tempo di riposo.  
L'abbreviazione appropriata è S4, seguita dal rapporto di intermittenza Ri, dal momento d'inerzia del motore e dal momento d'inerzia del carico, questi ultimi due riferiti all'albero motore.

**Intermittent periodic duty with starting S4<sup>(1)</sup>**  
A sequence of identical duty cycles, each cycle including a significant starting time, a time of operation at constant load and a time de-energized and at rest.  
The appropriate abbreviation is S4, followed by the cyclic duration factor Ri, the moment of inertia of the motor and the moment of inertia of the load, both referred to the motor shaft.

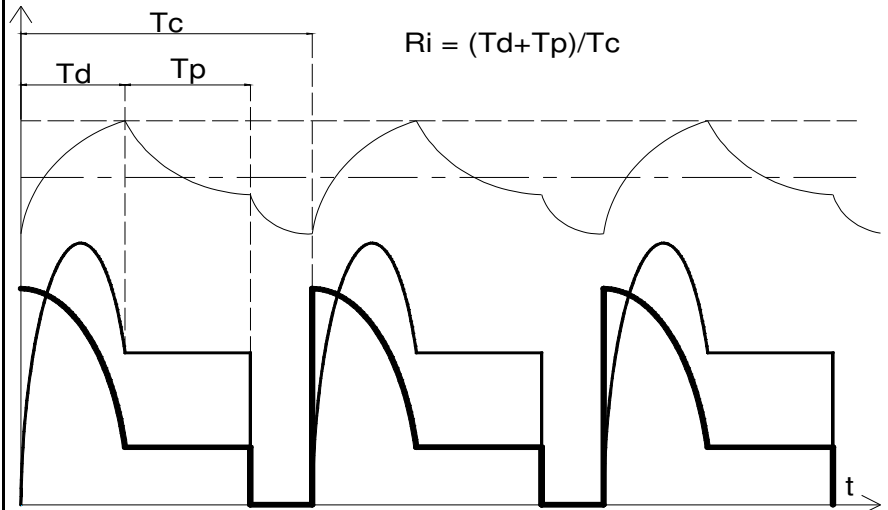

**Servizio intermittente periodico con frenatura elettrica S5<sup>(1)</sup>**  
Sequenza di cicli di funzionamento identici, ciascuno comprendente un tempo di avviamento, un tempo di funzionamento a carico costante, un tempo di frenatura elettrica rapida ed un tempo di riposo.  
L'abbreviazione appropriata è S5, seguita dal rapporto di intermittenza Ri, dal momento d'inerzia del motore e dal momento d'inerzia del carico, questi ultimi due riferiti all'albero motore.

**Intermittent periodic duty with electric braking S5<sup>(1)</sup>**  
A sequence of identical duty cycles, each cycle consisting of a starting time, a time of operation at constant load, a time of electric braking and a time de-energized and at rest.  
The appropriate abbreviation is S5, followed by the cyclic duration factor Ri, the moment of inertia of the motor and the moment of inertia of the load, both referred to the motor shaft.

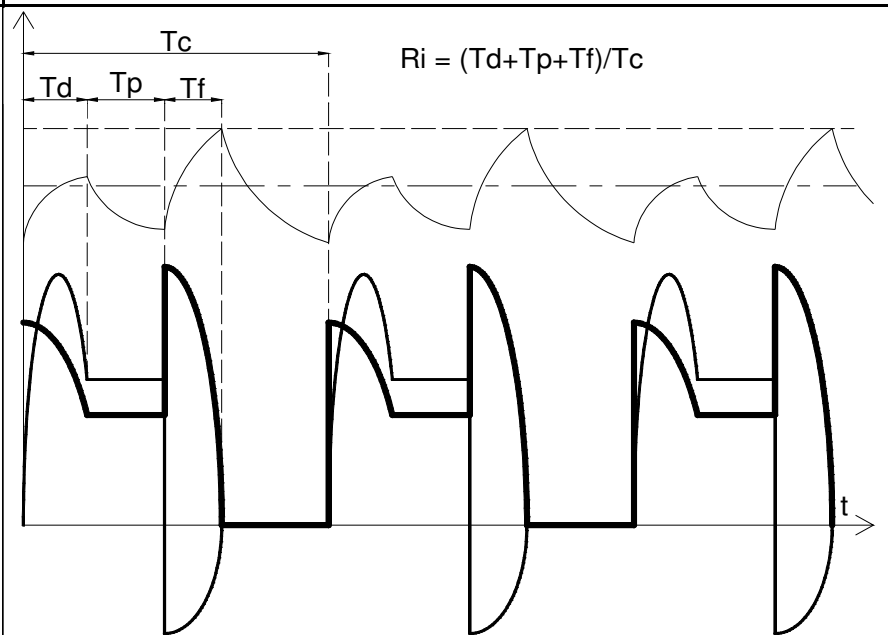

**Servizio ininterrotto periodico S6<sup>(1)</sup>**  
Sequenza di cicli di funzionamento identici, ciascuno comprendente un tempo di funzionamento a carico costante ed un tempo di funzionamento a vuoto. Non esiste alcun tempo di riposo.  
L'abbreviazione appropriata è S6, seguita dal rapporto d'intermittenza Ri.

**Continuous-operation periodic duty S6<sup>(1)</sup>**  
A sequence of identical duty cycles, each cycle consisting of a time of operation at constant load and a time of operation at no-load. There is no time de-energized and at rest.  
The appropriate abbreviation is S6, followed by the cyclic duration factor Ri.

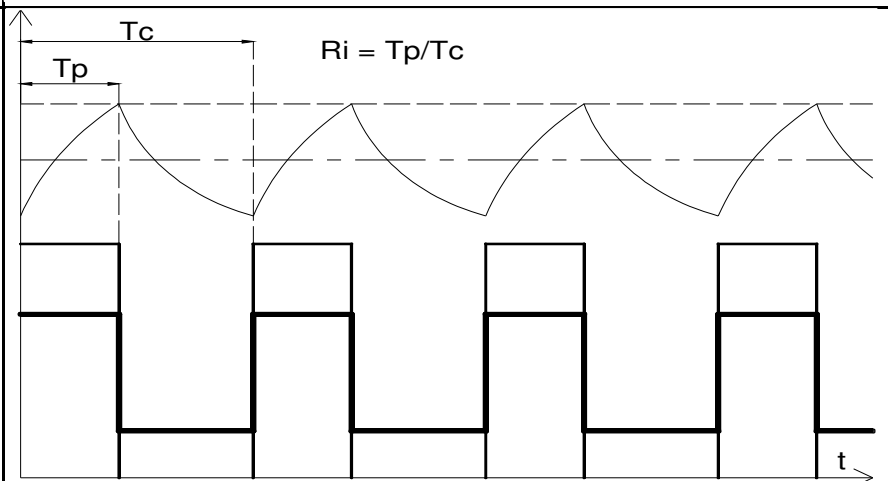

(1) Il servizio periodico implica che l'equilibrio termico non è raggiunto durante il periodo a carico.

(1) Periodic duty implies that thermal equilibrium is not reached during the time on load.



## TIPI DI SERVIZIO E IDENTIFICAZIONE DEL SERVIZIO

Tabella/Tables  
N° 9

## DUTY TYPES AND DECLARATION OF DUTY

Foglio/Sheet  
N° 3

----- Max  
 T: Temperature    - - - - - Average  
 ————— Instantaneous

P: Carico  
load

Pv: Perdite elettriche  
Electrical losses

n: Velocità  
speed

### Servizio ininterrotto periodico con frenatura elettrica S7<sup>(1)</sup>

Sequenza di cicli di funzionamento identici, ciascuno comprendente un tempo di avviamento, un tempo di funzionamento a carico costante ed un tempo di frenatura elettrica. Non esiste alcun periodo di riposo. L'abbreviazione appropriata è S7, seguita dal momento d'inerzia del motore e dal momento d'inerzia del carico, entrambi riferiti all'albero motore.

### Continuous-operation periodic duty with electric braking S7<sup>(1)</sup>

A sequence of identical duty cycles, each cycle consisting of a starting time, a time of operation at constant load and a time of electric braking. There is no time de-energized and at rest. The appropriate abbreviation is S7, followed by the moment of inertia of the motor and the moment of inertia of the load, both referred to the motor shaft.

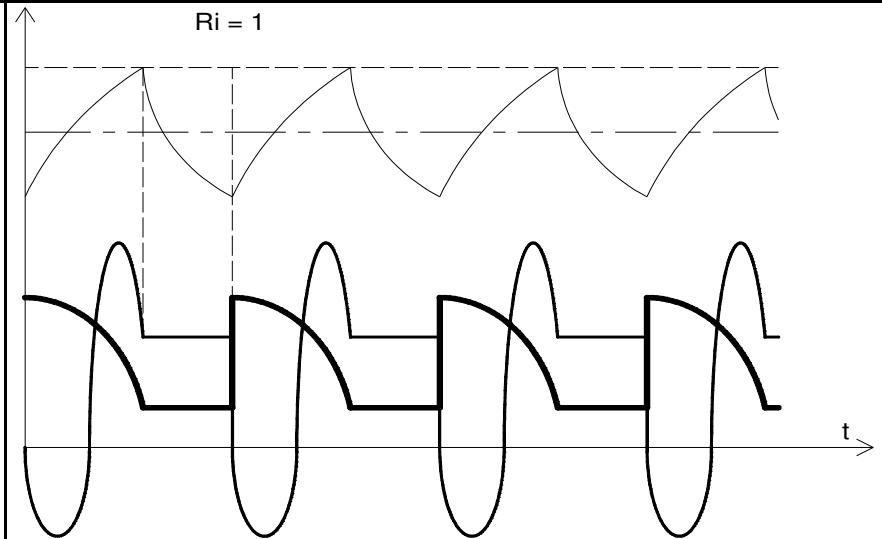

### Servizio ininterrotto periodico con variazioni correlate di carico e velocità S8<sup>(1)</sup>

Sequenza di cicli di funzionamento identici, ciascuno comprendente un tempo di funzionamento a carico costante corrispondente ad una prestabilita velocità di rotazione, seguito da uno o più tempi di funzionamento con altri carichi costanti corrispondenti a diverse velocità di rotazione (realizzato per esempio mediante cambio del numero di poli nel caso dei motori a induzione). Non esiste alcun tempo di riposo. L'abbreviazione appropriata è S8, seguita dal momento d'inerzia del motore e dal momento d'inerzia del carico, entrambi riferiti all'albero del motore, insieme al carico, alla velocità e al rapporto di intermittenza Ri, per ogni regime caratterizzato da una determinata velocità.

### Continuous-operation periodic duty with related load/speed changes S8<sup>(1)</sup>

A sequence of identical duty cycles, each cycle consisting of a time of operation at constant load corresponding to a predetermined speed of rotation, followed by one or more times of operation at other constant loads corresponding to different speed of rotation (carried out, for example, by means of a change in the number of poles in the case of induction motors). There is no time de-energized and at rest. The appropriate abbreviation is S8, followed by the moment of inertia of the motor and the moment of inertia of the load, both referred to the motor shaft, together with the load, speed and cyclic duration factor Ri for each speed condition.

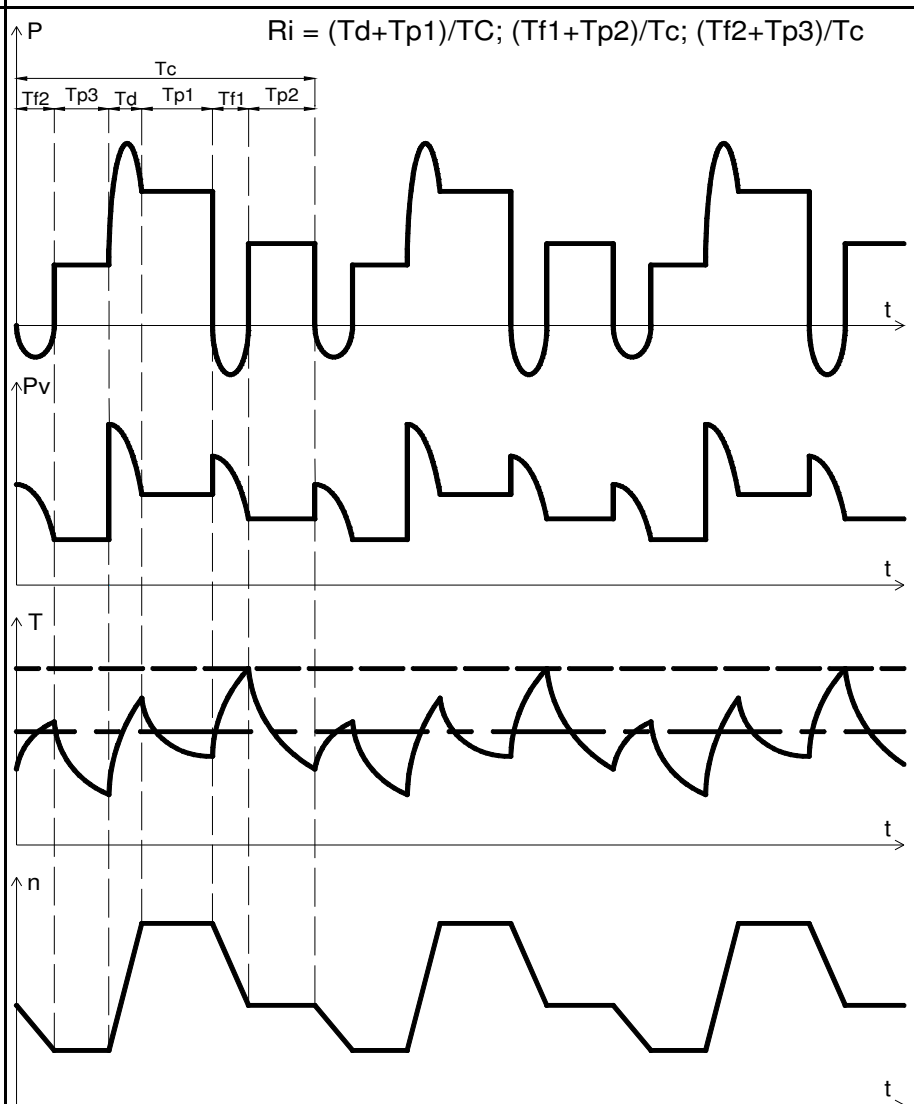

(1) Il servizio periodico implica che l'equilibrio termico non è raggiunto durante il periodo a carico.

(1) Periodic duty implies that thermal equilibrium is not reached during the time on load.



## TIPI DI SERVIZIO E IDENTIFICAZIONE DEL SERVIZIO

Tabella/Tables  
N° 9

## DUTY TYPES AND DECLARATION OF DUTY

Foglio/Sheet  
N° 4

----- Max  
 T: Temperature    - - - - - Average  
 ————— Instantaneous

P: Carico  
load

Pv: Perdite elettriche  
Electrical losses

n: Velocità  
speed

### Servizio con variazioni non periodiche di carico e velocità S9

Servizio in cui generalmente il carico e la velocità variano in modo non periodico nel campo di funzionamento ammissibile. Questo servizio comprende sovraccarichi frequentemente applicati che possono essere largamente superiori ai valori di pieno carico.

L'abbreviazione appropriata è S9. Per questo tipo di servizio si prende come valore di riferimento per il concetto di sovraccarico un carico costante adeguatamente scelto e basato sul tipo di servizio S1.

### Duty with non-periodic load and speed variations S9

A duty in which generally load and speed vary non-periodically within the permissible operating range. This duty includes frequently applied overloads that may greatly exceed the reference load.

The appropriate abbreviation is S9. For this duty type, a constant load appropriately selected and based on duty type S1 is taken as the reference value for the overload concept.

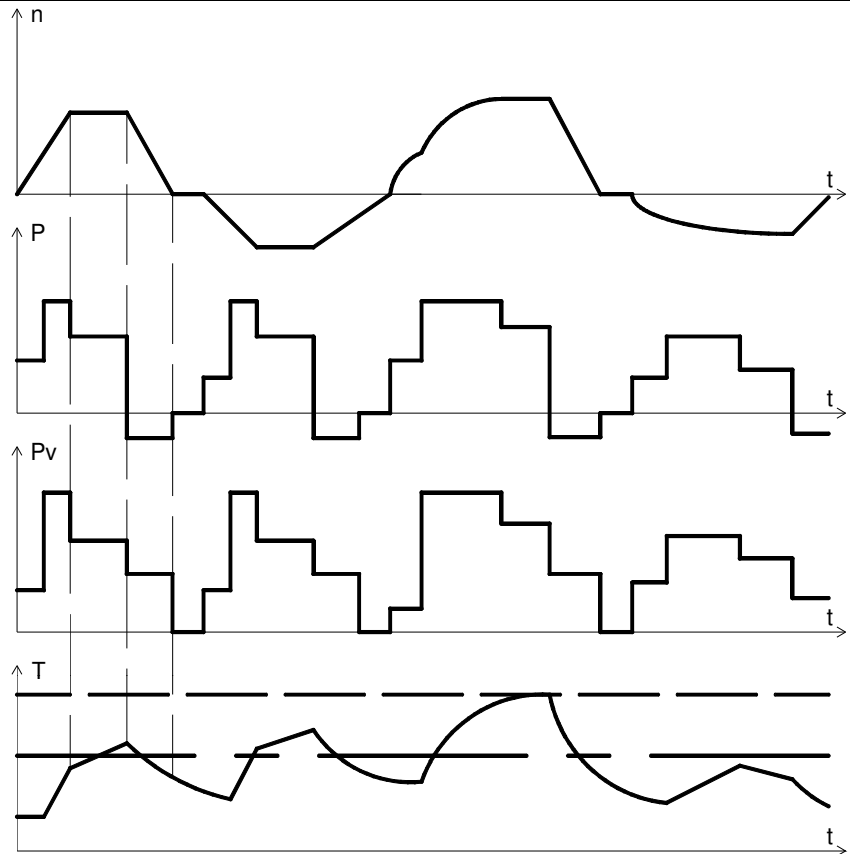

### Servizio con carichi distinti costanti S10

Servizio che consiste in un numero specifico di valori distinti di carico (o carico equivalente), mantenendo ogni valore per un tempo sufficiente per consentire alla macchina di raggiungere l'equilibrio termico. Il carico minimo durante un ciclo di servizio può avere valore zero (a vuoto o in stato di riposo).

L'abbreviazione appropriata è S10. Per questo tipo di servizio, deve essere assunto come valore di riferimento per i carichi distinti un carico costante adeguatamente scelto e basato sul servizio S1.

### Duty with discrete constant loads and speeds S10

A duty consisting of a specific number of discrete values of load (or equivalent loading) and if applicable, speed, each load/speed combination being maintained for sufficient time to allow the machine to reach thermal equilibrium. The minimum load within a duty cycle may have the value zero (no-load or de-energized and at rest).

The appropriate abbreviation is S10. For this duty type a constant load appropriately selected and based on duty type S1 shall be taken as the reference value for the discrete loads.

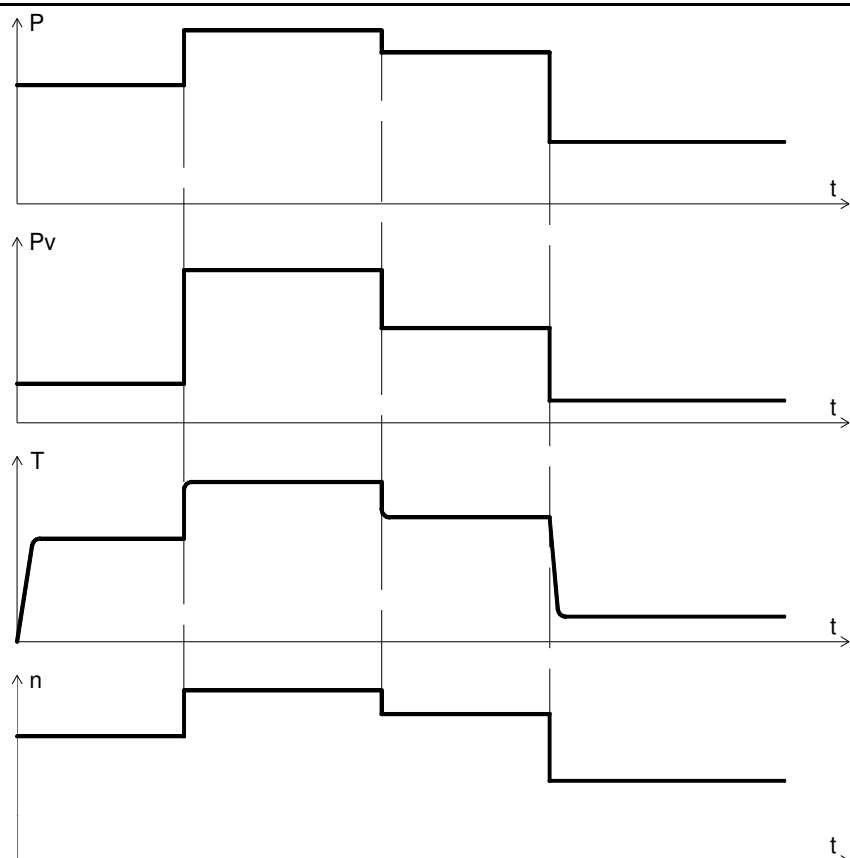



**Motori Serie MGL  
Motoren Serie MGL  
Motor Series MGL**

Tabella / Tisch / Tables  
N° 14 C

Foglio / Seite / Sheet  
N° 1

TIPO TYP TYPE			Momento inerzia Trageistsmoment Moment of inertia		Eccitazione Erregung Excitation		Dati di Ventilazione Angaben über die belufung Ventilation Data			
	PESO GEWICHT WEIGHT	Velocità Drehzahl Speed Max	PD2	J	Costante di tempo Feldzeitconstant Time Constant	Potenza Erregerleistung Power	Potenza Leistung Out Put	Pressione Druck Pressure	Portata Forderstrom Air Flow	
	Kg	giri/1' u/min r.p.m.	Kgm <sup>2</sup>	Kgm <sup>2</sup>	ms	W	50Hz kW	mm H <sub>2</sub> O	m <sup>3</sup> /1'	
80	S	40	5000	0.028	0.007	95	230	0.12	45	4
	M	46		0.034	0.0085	120	260			
	L	53		0.044	0.011	145	290			
100	S	64	5000	0.076	0.019	140	350	0.25	70	6
	M	72		0.092	0.023	165	380			
	L	82		0.112	0.028	180	430			
112	S	82	5000	0.156	0.039	130	500	0.25	70	6
	M	92		0.188	0.047	140	550			
	L	110		0.228	0.057	150	600			
132	S	139	5000	0.380	0.095	160	650	0.55	80	10
	M	155		0.452	0.113	175	750			
	L	175		0.546	0.137	190	850			
	P	195		0.620	0.155	209	950			
160	K	220	4500	0.80	0.20	210	920	1.1	100	18
	S	238		0.92	0.23	230	1000			
	M	264		1.12	0.28	260	1100			
	L	302		1.36	0.34	290	1200			
	P	320		1.48	0.37	310	1300			



TABELLA SELEZIONE MOTORI  
MGL 80 - 100 - 112

DATA: 01/12/2011

Foglio 1 di 2







TABELLA SELEZIONE MOTORI  
MGL 132 - 160

DATA: 01/12/2011

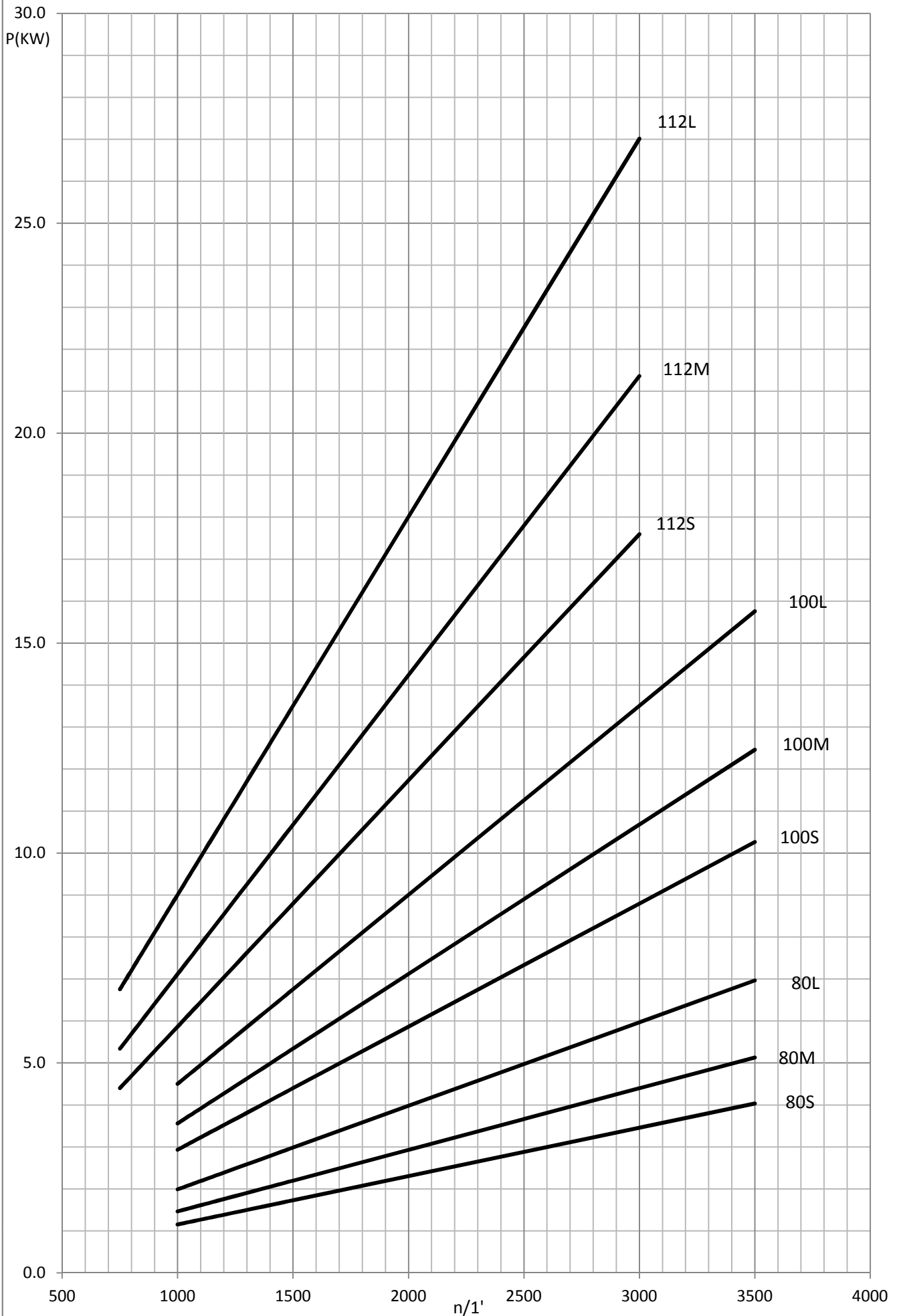
Foglio 2 di 2

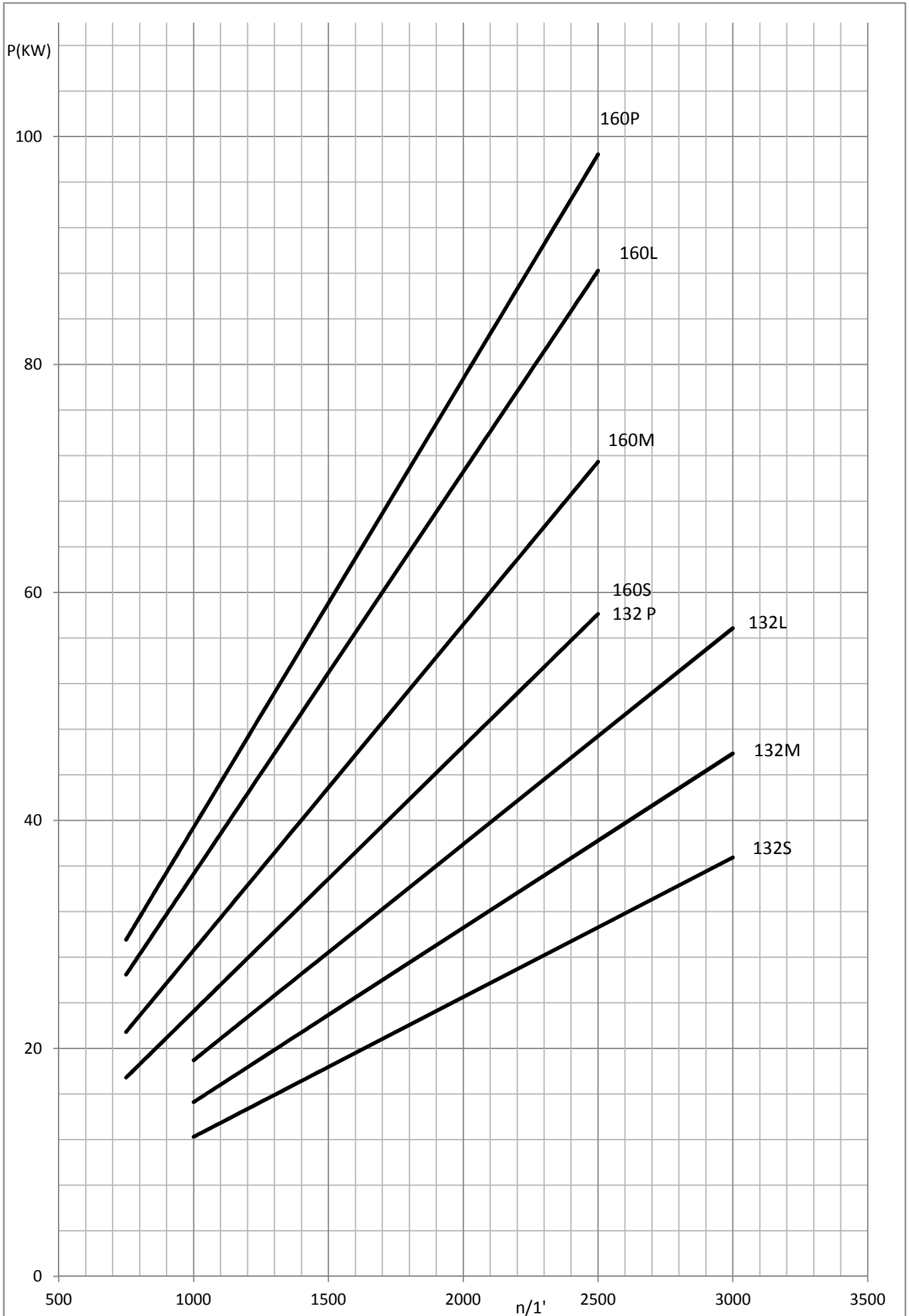



Potenza eccitazione  
Excitation power (w) 230  
Cost. tempo eccitaz.  
Field time constant (ms) 95  
Massa del motore  
Mass of the motor (Kg) 40  
Momento d'inerzia rotore  
Rotor inertia moment (Kgm2) 0.007

Tipo  
Size MGL 80 S  
Ventilazione  
Ventilation IC 06

Avv.	Velocità nominale n/min a tensione nominale di armatura Rated speed (rev/min) at rated voltage							Potenza Power kW	Coppia vel.nomin. Torque at rated speed Nm	Rendimento Efficiency %	Circuito di armatura Armature circuit			Max giri Max. speed (°)
	170	220	260	300	400	440	500				Corrente Current Amp	Res. 115°C mOhm	Ind. mH	
50	4035	---	---	---	---	---	---	4.56	10.8	84.9	31.6	476	3.83	4700
51	3645	---	---	---	---	---	---	3.89	10.2	84.1	27.2	586	4.48	4700
52	3310	---	---	---	---	---	---	3.54	10.2	83.3	25	696	5.40	4700
		4410	---	---	---	---	---	4.71	10.2	85.6	25			
53	3015	---	---	---	---	---	---	3.41	10.8	82.5	24.3	794	6.40	4700
		4030	---	---	---	---	---	4.55	10.8	85.1	24.3			
54	2765	---	---	---	---	---	---	3.13	10.8	81.5	22.6	939	7.41	4424
		3710	---	---	---	---	---	4.19	10.8	84.3	22.6			
		4460	---	---	---	---	---	5.05	10.8	85.9	22.6			
55	2385	---	---	---	---	---	---	2.60	10.4	80.1	19.1	1220	9.51	3814
		3210	---	---	---	---	---	3.50	10.4	83.3	19.1			
		3870	---	---	---	---	---	4.22	10.4	85.0	19.1			
		4530	---	---	---	---	---	4.94	10.4	86.2	19.1			
56	2070	---	---	---	---	---	---	2.30	10.6	78.2	17.3	1550	12.2	3310
		2800	---	---	---	---	---	3.12	10.6	82.0	17.3			
		3390	---	---	---	---	---	3.77	10.6	83.8	17.3			
		3975	---	---	---	---	---	4.42	10.6	85.2	17.3			

Nota (\*) - VENTILAZIONE SOLO L.O. / FAN ONLY SIDE COMMUTATOR

Nota (°) - Regolazione di campo / Field weakening



Potenza eccitazione Excitation power	(w)	230	Tipo Size MGL 80 S Ventilazione Ventilation IC 06
Cost. tempo eccitaz. Field time constant	(ms)	95	
Massa del motore Mass of the motor	(Kg)	40	
Momento d'inerzia rotore Rotor inertia moment	(Kgm2)	0.007	

Avv.	Velocità nominale n/min a tensione nominale di armatura Rated speed (rev/min) at rated voltage							Potenza Power kW	Coppia vel.nomin. Torque at rated speed Nm	Rendimento Efficiency %	Circuito di armatura Armature circuit			Max giri Max. speed (°)
	170	220	260	300	400	440	500				Corrente Current Amp	Res. 115°C mOhm	Ind. mH	
57	1930	---	---	---	---	---	---	2.16	10.7	77.0	16.5	1760	13.6	3087
		2625	---	---	---	---	---	2.94	10.7	81.0	16.5			4198
		---	3180	---	---	---	---	3.56	10.7	83.0	16.5			4700
		---	---	3735	---	---	---	4.18	10.7	84.4	16.5			4700
58	1705	---	---	---	---	---	---	1.89	10.6	75.1	14.8	2180	16.5	2728
		2335	---	---	---	---	---	2.59	10.6	79.5	14.8			3734
		---	2835	---	---	---	---	3.15	10.6	81.9	14.8			4538
		---	---	3340	---	---	---	3.71	10.6	83.6	14.8			4700
59	1545	---	---	---	---	---	---	1.74	10.8	74.7	13.7	2440	19.8	2469
		2115	---	---	---	---	---	2.38	10.7	79.0	13.7			3387
		---	2575	---	---	---	---	2.90	10.8	81.4	13.7			4122
		---	---	3035	---	---	---	3.42	10.8	83.2	13.7			4700
60	1385	---	---	---	---	---	---	1.57	10.8	72.7	12.7	2890	23.4	2215
		1910	---	---	---	---	---	2.17	10.8	77.7	12.7			3060
		---	2335	---	---	---	---	2.65	10.8	80.3	12.7			3735
		---	---	2755	---	---	---	3.13	10.8	82.2	12.7			4411
61	1240	---	---	---	---	---	---	1.39	10.7	70.5	11.6	3520	27.3	1987
		1730	---	---	---	---	---	1.94	10.7	76.0	11.6			2769
		---	2120	---	---	---	---	2.38	10.7	78.9	11.6			3394
		---	---	2510	---	---	---	2.82	10.7	81.0	11.6			4020
62	1080	---	---	---	---	---	---	1.19	10.5	68.0	10.3	4370	33.5	1730
		1520	---	---	---	---	---	1.68	10.6	74.1	10.3			2433
		---	1875	---	---	---	---	2.07	10.5	77.3	10.3			2996
		---	---	2225	---	---	---	2.46	10.6	79.6	10.3			3560
63	910	---	---	---	---	---	---	1.01	10.6	65.3	9.1	5600	43.5	1452
		1295	---	---	---	---	---	1.44	10.6	71.9	9.1			2073
		---	1605	---	---	---	---	1.78	10.6	75.2	9.1			2570
		---	---	1915	---	---	---	2.12	10.6	77.7	9.1			3067
63	910	---	---	---	---	---	---	2.98	10.6	81.9	9.1	5600	43.5	4309
		---	---	---	---	---	---	3.33	10.6	83.2	9.1			4700
		---	---	---	---	---	---	3.84	10.6	84.4	9.1			4700
		---	---	---	---	---	---	---	---	---	---			---

Nota (\*) - VENTILAZIONE SOLO L.O. / FAN ONLY SIDE COMMUTATOR

Nota (°) - Regolazione di campo / Field weakening



Potenza eccitazione Excitation power (w) 230	
Cost. tempo eccitaz. Field time constant (ms) 95	
Massa del motore Mass of the motor (Kg) 40	
Momento d'inerzia rotore Rotor inertia moment (Kgm2) 0.007	
Tipo Size MGL 80 S	
Ventilazione Ventilation IC 06	

Avv.	Velocità nominale n/min a tensione nominale di armatura Rated speed (rev/min) at rated voltage							Potenza Power kW	Coppia vel.nomin. Torque at rated speed Nm	Rendimento Efficiency %	Circuito di armatura Armature circuit			Max giri Max. speed (°)
	170	220	260	300	400	440	500				Corrente Current Amp	Res. 115°C mOhm	Ind. mH	
64		1080	--- 1350	--- 1620	--- 2300	--- 2570	--- 2975	1.21 1.51 1.81 2.57 2.87 3.33	10.7 10.7 10.7 10.7 10.7 10.7	68.8 72.6 75.4 80.3 81.5 83.3	8.0 8.0 8.0 8.0 8.0 8.0	7290	57.3	1728 2161 2594 3677 4110 4700
65		970	--- 1220	--- 1470	--- 2100	--- 2350	--- 2730	1.09 1.38 1.66 2.37 2.66 3.08	10.7 10.8 10.8 10.8 10.8 10.8	66.1 70.8 73.8 79.0 80.6 82.1	7.5 7.5 7.5 7.5 7.5 7.5	8490	65.9	1551 1953 2355 3361 3763 4366
66		890	--- 1125	--- 1355	--- 1945	--- 2180	--- 2530	1.02 1.29 1.56 2.23 2.50 2.90	10.9 10.9 11.0 10.9 11.0 10.9	65.3 69.9 73.2 78.5 80.0 81.7	7.1 7.1 7.1 7.1 7.1 7.1	9360	76.2	1421 1797 2172 3110 3486 4049
67		800	--- 1020	--- 1240	--- 1790	--- 2010	--- 2340	0.91 1.16 1.41 2.03 2.28 2.66	10.9 10.9 10.9 10.8 10.8 10.9	62.7 67.6 71.2 76.9 78.5 80.6	6.6 6.6 6.6 6.6 6.6 6.6	10900	87.3	1282 1634 1986 2866 3217 3745
68			940	--- 1145	--- 1665	--- 1870	--- 2180	1.07 1.30 1.89 2.12 2.47	10.9 10.8 10.8 10.8 10.8	66.4 69.9 76.2 77.7 79.7	6.2 6.2 6.2 6.2 6.2	12300	99.4	1504 1836 2664 2995 3492
69			800	--- 990	--- 1450	--- 1635	--- 1915	0.92 1.13 1.66 1.87 2.19	11.0 10.9 10.9 10.9 10.9	63.2 67.3 74.1 75.9 78.2	5.6 5.6 5.6 5.6 5.6	15100	124	1284 1580 2321 2617 3062
70				850	--- 1270	--- 1435	--- 1690	0.96 1.43 1.62 1.91	10.8 10.8 10.8 10.8	64.0 71.5 73.6 76.4	5.0 5.0 5.0 5.0	19000	150	1360 2030 2298 2700

Nota (\*) - VENTILAZIONE SOLO L.O. / FAN ONLY SIDE COMMUTATOR

Nota (°) - Regolazione di campo / Field weakening



Potenza eccitazione Excitation power	(w)	230	Tipo Size MGL 80 S Ventilazione Ventilation IC 06
Cost. tempo eccitaz. Field time constant	(ms)	95	
Massa del motore Mass of the motor	(Kg)	40	
Momento d'inerzia rotore Rotor inertia moment	(Kgm2)	0.007	

Avv.	Velocità nominale n/min a tensione nominale di armatura Rated speed (rev/min) at rated voltage							Potenza Power	Coppia vel.nomin. Torque at rated speed Nm	Rendimento Efficiency	Circuito di armatura Armature circuit			Max giri Max. speed	
	170	220	260	300	400	440	500	kW		%	Corrente Current Amp	Res. 115°C mOhm	Ind. mH	(°)	
71					1125	---	---	1.22	10.4	69.3	4.4	23700	179	1797	
					1275	---	---	1.39	10.4	71.8	4.4				2042
					1505	---	---	1.64	10.4	74.5	4.4				2409
72					1015	---	---	1.15	10.8	68.5	4.2	25900	214	1627	
					1160	---	---	1.31	10.8	70.9	4.2				1852
					1370	---	---	1.55	10.8	73.8	4.2				2190

Nota (\*) - VENTILAZIONE SOLO L.O. / FAN ONLY SIDE COMMUTATOR

Nota (°) - Regolazione di campo / Field weakening



Potenza eccitazione Excitation power	(w)	260	Tipo Size MGL 80 M Ventilazione Ventilation IC 06
Cost. tempo eccitaz. Field time constant	(ms)	120	
Massa del motore Mass of the motor	(Kg)	46.0	
Momento d'inerzia rotore Rotor inertia moment	(Kgm2)	0.0085	

Avv.	Velocità nominale n/min a tensione nominale di armatura Rated speed (rev/min) at rated voltage							Potenza Power kW	Coppia vel.nomin. Torque at rated speed Nm	Rendimento Efficiency %	Circuito di armatura Armature circuit			Max giri Max. speed (°)
	170	220	260	300	400	440	500				Corrente Current Amp	Res. 115°C mOhm	Ind. mH	
50	3095	---	---	---	---	---	---	4.56	14.1	84.9	31.6	534	4.96	4700
		4125	---	---	---	---	---	6.07	14.1	87.3	31.6			
51	2795	---	---	---	---	---	---	3.89	13.3	84.1	27.2	659	5.80	4474
		3730	---	---	---	---	---	5.18	13.3	86.6	27.2			
		4475	---	---	---	---	---	6.22	13.3	88.0	27.2			
52	2535	---	---	---	---	---	---	3.53	13.3	83.1	25.0	781	7.00	4058
		3390	---	---	---	---	---	4.72	13.3	85.8	25.0			
		4075	---	---	---	---	---	5.68	13.3	87.4	25.0			
53	2305	---	---	---	---	---	---	3.39	14.0	82.1	24.3	892	8.29	3691
		3095	---	---	---	---	---	4.55	14.0	85.1	24.3			
		3725	---	---	---	---	---	5.48	14.0	86.7	24.3			
		4360	---	---	---	---	---	6.41	14.0	87.9	24.3			
54	2110	---	---	---	---	---	---	3.11	14.1	80.9	22.6	1050	9.60	3378
		2845	---	---	---	---	---	4.19	14.1	84.3	22.6			
		3430	---	---	---	---	---	5.05	14.1	85.9	22.6			
		4015	---	---	---	---	---	5.92	14.1	87.3	22.6			
55	1815	---	---	---	---	---	---	2.58	13.6	79.5	19.1	1380	12.3	2904
		2455	---	---	---	---	---	3.49	13.6	83.1	19.1			
		2970	---	---	---	---	---	4.22	13.6	85.0	19.1			
		3480	---	---	---	---	---	4.95	13.6	86.4	19.1			
56	1570	---	---	---	---	---	---	2.27	13.8	77.2	17.3	1740	15.8	2512
		2140	---	---	---	---	---	3.10	13.8	81.5	17.3			
		2595	---	---	---	---	---	3.76	13.8	83.6	17.3			
		3050	---	---	---	---	---	4.42	13.8	85.2	17.3			
		4190	---	---	---	---	---	6.07	13.8	87.7	17.3			
		4645	---	---	---	---	---	6.73	13.8	88.4	17.3			

Nota (\*) - VENTILAZIONE SOLO L.O. / FAN ONLY SIDE COMMUTATOR

Nota (°) - Regolazione di campo / Field weakening



Potenza eccitazione Excitation power	(w)	260	Tipo Size MGL 80 M Ventilazione Ventilation IC 06
Cost. tempo eccitaz. Field time constant	(ms)	120	
Massa del motore Mass of the motor	(Kg)	46.0	
Momento d'inerzia rotore Rotor inertia moment	(Kgm2)	0.0085	

Avv.	Velocità nominale n/min a tensione nominale di armatura Rated speed (rev/min) at rated voltage							Potenza Power kW	Coppia vel.nomin. Torque at rated speed Nm	Rendimento Efficiency %	Circuito di armatura Armature circuit			Max giri Max. speed (°)
	170	220	260	300	400	440	500				Corrente Current Amp	Res. 115°C mOhm	Ind. mH	
57	1460	---	---	---	---	---	---	2.13	13.9	72.4	17.3	1970	17.70	2338
		2000	---	---	---	---	---	2.92	13.9	76.7	17.3			3201
		---	2435	---	---	---	---	3.55	13.9	78.9	17.3			3892
		---	---	2865	---	---	---	4.18	13.9	80.5	17.3			4583
		---	---	---	3945	---	---	5.75	13.9	83.1	17.3			4700
		---	---	---	---	---	4375	6.38	13.9	83.8	17.3			4700
		---	---	---	---	---	---	---	---	---	---			---
58	1285	---	---	---	---	---	---	1.86	13.8	73.9	14.8	2440	21.40	2058
		1775	---	---	---	---	---	2.57	13.8	78.9	14.8			2840
		---	2165	---	---	---	---	3.13	13.8	81.3	14.8			3465
		---	---	2555	---	---	---	3.70	13.8	83.3	14.8			4090
		---	---	---	3535	---	---	5.11	13.8	86.3	14.8			4700
		---	---	---	---	3925	---	5.67	13.8	87.1	14.8			4700
		---	---	---	---	---	4510	6.52	13.8	88.1	14.8			4700
59	1160	---	---	---	---	---	---	1.71	14.1	73.4	13.7	2740	25.6	1860
		1610	---	---	---	---	---	2.36	14.0	78.3	13.7			2573
		---	1965	---	---	---	---	2.88	14.0	80.9	13.7			3144
		---	---	2320	---	---	---	3.41	14.0	83.0	13.7			3715
		---	---	---	3215	---	---	4.71	14.0	85.9	13.7			4700
		---	---	---	---	3570	---	5.24	14.0	86.9	13.7			4700
		---	---	---	---	---	4105	6.02	14.0	87.9	13.7			4700
60	1040	---	---	---	---	---	---	1.54	14.1	71.3	12.7	3250	30.3	1662
		1450	---	---	---	---	---	2.14	14.1	76.6	12.7			2318
		---	1775	---	---	---	---	2.63	14.1	79.6	12.7			2843
		---	---	2105	---	---	---	3.12	14.2	81.9	12.7			3369
		---	---	---	2925	---	---	4.33	14.1	85.2	12.7			4681
		---	---	---	---	3255	---	4.81	14.1	86.1	12.7			4700
		---	---	---	---	---	3745	5.54	14.1	87.2	12.7			4700
61	925	---	---	---	---	---	---	1.35	13.9	68.5	11.6	3960	35.4	1483
		1305	---	---	---	---	---	1.91	14.0	74.8	11.6			2090
		---	1610	---	---	---	---	2.35	13.9	77.9	11.6			2577
		---	---	1915	---	---	---	2.79	13.9	80.2	11.6			3063
		---	---	---	2675	---	---	3.90	13.9	84.1	11.6			4278
		---	---	---	---	2980	---	4.35	13.9	85.2	11.6			4700
		---	---	---	---	---	3435	5.01	13.9	86.4	11.6			4700
62	800	---	---	---	---	---	---	1.15	13.7	65.7	10.3	4910	43.4	1283
		1145	---	---	---	---	---	1.65	13.8	72.8	10.3			1830
		---	1415	---	---	---	---	2.04	13.8	76.2	10.3			2268
		---	---	1690	---	---	---	2.43	13.7	78.6	10.3			2705
		---	---	---	2375	---	---	3.42	13.8	83.0	10.3			3799
		---	---	---	---	2650	---	3.81	13.7	84.1	10.3			4237
		---	---	---	---	---	3060	4.40	13.7	85.4	10.3			4700
63	665	---	---	---	---	---	---	0.96	13.8	62.1	9.10	6290	56.3	1068
		970	---	---	---	---	---	1.40	13.8	69.9	9.10			1550
		---	1210	---	---	---	---	1.75	13.8	74.0	9.10			1937
		---	---	1450	---	---	---	2.09	13.8	76.6	9.10			2323
		---	---	---	2055	---	---	2.96	13.8	81.3	9.10			3288
		---	---	---	---	2295	---	3.31	13.8	82.7	9.10			3674
		---	---	---	---	---	2660	3.83	13.7	84.2	9.10			4253

Nota (\*) - VENTILAZIONE SOLO L.O. / FAN ONLY SIDE COMMUTATOR

Nota (°) - Regolazione di campo / Field weakening



Potenza eccitazione Excitation power (w)	260	Tipo Size MGL 80 M Ventilazione Ventilation IC 06
Cost. tempo eccitaz. Field time constant (ms)	120	
Massa del motore Mass of the motor (Kg)	46.0	
Momento d'inerzia rotore Rotor inertia moment (Kgm2)	0.0085	

Avv.	Velocità nominale n/min a tensione nominale di armatura Rated speed (rev/min) at rated voltage							Potenza Power kW	Coppia vel. nomin. Torque at rated speed Nm	Rendimento Efficiency %	Circuito di armatura Armature circuit			Max giri Max. speed (°)
	170	220	260	300	400	440	500				Corrente Current Amp	Res. 115°C mOhm	Ind. mH	
64		800	--- 1010	--- --- 1220	--- --- 1750	--- --- 1960	--- 2275	1.17 1.47 1.78 2.55 2.85 3.31	14.0 13.9 13.9 13.9 13.9 13.9	66.5 70.7 74.2 79.7 81.0 82.8	8.0 8.0 8.0 8.0 8.0 8.0	8180 74.2	1283 1619 1956 2797 3134 3639	
65		715	--- 910	--- --- 1105	--- --- 1595	--- --- 1790	2080	1.05 1.34 1.63 2.34 2.63 3.06	14.0 14.1 14.1 14.0 14.0 14.0	63.6 68.7 72.4 78.0 79.7 81.6	7.5 7.5 7.5 7.5 7.5 7.5	9540 85.4	1144 1456 1769 2550 2863 3331	
66		655	--- 835	--- --- 1020	--- --- 1475	--- --- 1655	1930	0.97 1.25 1.52 2.20 2.47 2.88	14.1 14.3 14.2 14.2 14.3 14.2	62.1 67.7 71.4 77.5 79.1 81.1	7.1 7.1 7.1 7.1 7.1 7.1	10500 98.7	1045 1337 1628 2358 2649 3087	
67			755	--- 925	--- --- 1355	--- --- 1525	1780	1.12 1.37 2.00 2.25 2.63	14.2 14.1 14.1 14.1 14.1	65.3 69.2 75.8 77.5 79.7	6.6 6.6 6.6 6.6 6.6	12300 113	1209 1483 2166 2440 2850	
68			695	--- 855	--- --- 1255	--- --- 1415	1660	1.02 1.26 1.85 2.09 2.45	14.0 14.1 14.1 14.1 14.1	63.3 67.7 74.6 76.6 79.0	6.2 6.2 6.2 6.2 6.2	13800 129	1110 1367 2010 2268 2654	
69				730	--- 1090	--- --- 1235	1450	1.09 1.62 1.84 2.16	14.3 14.2 14.2 14.2	64.9 72.3 74.7 77.1	5.6 5.6 5.6 5.6	16900 161	1169 1744 1975 2320	
70					950	--- 1080	1275	1.40 1.59 1.87	14.1 14.1 14.0	70.0 72.3 74.8	5.0 5.0 5.0	21300 195	1517 1726 2038	

Nota (\*) - VENTILAZIONE SOLO L.O. / FAN ONLY SIDE COMMUTATOR

Nota (°) - Regolazione di campo / Field weakening





Potenza eccitazione Excitation power	(w)	260	Tipo Size MGL 80 M Ventilazione Ventilation IC 06
Cost. tempo eccitaz. Field time constant	(ms)	120	
Massa del motore Mass of the motor	(Kg)	46.0	
Momento d'inerzia rotore Rotor inertia moment	(Kgm2)	0.0085	

Avv.	Velocità nominale n/min a tensione nominale di armatura Rated speed (rev/min) at rated voltage							Potenza Power	Coppia vel.nomin. Torque at rated speed Nm	Rendimento Efficiency	Circuito di armatura Armature circuit			Max giri Max. speed
	170	220	260	300	400	440	500	kW	%	Corrente Current Amp	Res. 115°C mOhm	Ind. mH	(°)	
71					835	---	---	1.18	13.5	67.0	4.4	26600	231	1335
						955	---	1.35	13.5	69.7	4.4			1525
							1130	1.60	13.5	72.7	4.4			1811
72					755	---	---	1.11	14.0	66.1	4.2	29100	277	1206
						865	---	1.27	14.0	68.7	4.2			1381
							1025	1.51	14.1	71.9	4.2			1643

Nota (\*) - VENTILAZIONE SOLO L.O. / FAN ONLY SIDE COMMUTATOR

Nota (°) - Regolazione di campo / Field weakening



Potenza eccitazione Excitation power	(w)	290	Tipo Size MGL 80 L Ventilazione Ventilation IC 06
Cost. tempo eccitaz. Field time constant	(ms)	145	
Massa del motore Mass of the motor	(Kg)	53	
Momento d'inerzia rotore Rotor inertia moment	(Kgm2)	0.011	

Avv.	Velocità nominale n/min a tensione nominale di armatura Rated speed (rev/min) at rated voltage							Potenza Power kW	Coppia vel.nomin. Torque at rated speed Nm	Rendimento Efficiency %	Circuito di armatura Armature circuit			Max giri Max. speed (°)
	170	220	260	300	400	440	500				Corrente Current Amp	Res. 115°C mOhm	Ind. mH	
50	2285	---	---	---	---	---	---	4.53	18.9	84.3	31.6	616	6.55	3653
		3055	---	---	---	---	---	6.05	18.9	87.0	31.6			4700
		3670	---	---	---	---	---	7.27	18.9	88.5	31.6			4700
			4285	---	---	---	---	8.49	18.9	89.6	31.6			4700
51	2060	---	---	---	---	---	---	3.86	17.9	83.5	27.2	761	7.66	3294
		2760	---	---	---	---	---	5.17	17.9	86.4	27.2			4416
		3315	---	---	---	---	---	6.21	17.9	87.8	27.2			4700
			3875	---	---	---	---	7.26	17.9	89.0	27.2			4700
52	1865	---	---	---	---	---	---	3.50	17.9	82.4	25	901	9.23	2982
		2505	---	---	---	---	---	4.71	18.0	85.6	25			4007
		3015	---	---	---	---	---	5.67	18.0	87.2	25			4700
			3530	---	---	---	---	6.63	17.9	88.4	25			4700
53	1690	---	---	---	---	---	---	3.35	18.9	81.1	24.3	1030	10.9	2706
		2285	---	---	---	---	---	4.52	18.9	84.5	24.3			3652
		2755	---	---	---	---	---	5.46	18.9	86.4	24.3			4410
			3230	---	---	---	---	6.40	18.9	87.8	24.3			4700
		4415	---	---	---	---	8.74	18.9	89.9	24.3	4700			
54	1545	---	---	---	---	---	---	3.06	18.9	79.6	22.6	1210	12.7	2469
		2095	---	---	---	---	---	4.15	18.9	83.5	22.6			3348
		2530	---	---	---	---	---	5.03	19.0	85.6	22.6			4052
			2970	---	---	---	---	5.90	19.0	87.0	22.6			4700
		4070	---	---	---	---	8.08	19.0	89.4	22.6	4700			
		4510	---	---	---	---	8.95	19.0	90.0	22.6	4700			
55	1320	---	---	---	---	---	---	2.53	18.3	77.9	19.1	1590	16.2	2115
		1805	---	---	---	---	---	3.45	18.3	82.1	19.1			2885
		2185	---	---	---	---	---	4.19	18.3	84.4	19.1			3500
			2570	---	---	---	---	4.92	18.3	85.9	19.1			4115
		3535	---	---	---	---	6.77	18.3	88.6	19.1	4700			
		3920	---	---	---	---	---	7.50	18.3	89.2	19.1			4700
			4495	---	---	---	---	8.61	18.3	90.2	19.1			4700
		56	1140	---	---	---	---	---	---	2.22	18.6			75.5
1565	---			---	---	---	---	3.06	18.7	80.4	17.3	2504		
1905	---			---	---	---	---	3.72	18.6	82.7	17.3	3051		
	2250			---	---	---	---	4.39	18.6	84.6	17.3	3598		
3105	---			---	---	---	6.06	18.6	87.6	17.3	4700			
3445	---			---	---	---	6.73	18.7	88.4	17.3	4700			
3960	---			---	---	---	7.73	18.6	89.4	17.3	4700			

Nota (\*) - VENTILAZIONE SOLO L.O. / FAN ONLY SIDE COMMUTATOR

Nota (°) - Regolazione di campo / Field weakening



Potenza eccitazione Excitation power (w) 290				
Cost. tempo eccitaz. Field time constant (ms) 145				
Massa del motore Mass of the motor (Kg) 53				
Momento d'inerzia rotore Rotor inertia moment (Kgm2) 0.011				
	Tipo	MGL	80	L
	Size			
	Ventilazione			IC 06
	Ventilation			

Avv.	Velocità nominale n/min a tensione nominale di armatura Rated speed (rev/min) at rated voltage							Potenza Power kW	Coppia vel.nomin. Torque at rated speed Nm	Rendimento Efficiency %	Circuito di armatura Armature circuit			Max giri Max. speed (°)
	170	220	260	300	400	440	500				Corrente Current Amp	Res. 115°C mOhm	Ind. mH	
57	1055	---	---	---	---	---	---	2.08	18.8	74.2	16.5	2270	23.3	1689
		1460	---	---	---	---	---	2.87	18.8	79.1	16.5			2337
			1785	---	---	---	---	3.51	18.8	81.8	16.5			2855
				2110	---	---	---	4.14	18.7	83.6	16.5			3373
					2920	---	---	5.74	18.8	87.0	16.5			4668
						3240	---	6.37	18.8	87.7	16.5			4700
							3725	7.33	18.8	88.8	16.5			4700
58	925	---	---	---	---	---	---	1.80	18.6	71.5	14.8	2820	28.2	1479
		1290	---	---	---	---	---	2.51	18.6	77.1	14.8			2065
			1585	---	---	---	---	3.09	18.6	80.3	14.8			2534
				1875	---	---	---	3.66	18.6	82.4	14.8			3003
					2610	---	---	5.08	18.6	85.8	14.8			4175
						2900	---	5.66	18.6	86.9	14.8			4643
							3340	6.51	18.6	88.0	14.8			4700
59	835	---	---	---	---	---	---	1.65	18.9	70.8	13.7	3160	33.7	1333
		1165	---	---	---	---	---	2.31	18.9	76.6	13.7			1868
			1435	---	---	---	---	2.84	18.9	79.7	13.7			2296
				1700	---	---	---	3.37	18.9	82.0	13.7			2724
					2370	---	---	4.69	18.9	85.6	13.7			3794
						2640	---	5.22	18.9	86.6	13.7			4222
							3040	6.01	18.9	87.7	13.7			4700
60	740	---	---	---	---	---	---	1.48	19.1	68.6	12.7	3750	40	1184
		1050	---	---	---	---	---	2.09	19.0	74.8	12.7			1676
			1295	---	---	---	---	2.58	19.0	78.1	12.7			2070
				1540	---	---	---	3.07	19.0	80.6	12.7			2460
					2155	---	---	4.30	19.1	84.6	12.7			3449
						2400	---	4.79	19.1	85.7	12.7			3842
							2770	5.52	19.0	86.9	12.7			4433
61	655	---	---	---	---	---	---	1.29	18.8	65.4	11.6	4570	46.7	1048
		940	---	---	---	---	---	1.85	18.8	72.5	11.6			1503
			1170	---	---	---	---	2.30	18.8	76.3	11.6			18636
				1395	---	---	---	2.74	18.8	78.7	11.6			2233
					1965	---	---	3.86	18.8	83.2	11.6			3144
						2195	---	4.31	18.8	84.4	11.6			3509
							2535	4.98	18.8	85.9	11.6			4056
62		820	---	---	---	---	---	1.59	18.5	70.2	10.3	5670	57.2	1308
			1025	---	---	---	---	1.98	18.4	73.9	10.3			1637
				1230	---	---	---	2.38	18.5	77.0	10.3			1965
					1740	---	---	3.38	18.5	82.0	10.3			2785
						1945	---	3.77	18.5	83.2	10.3			3113
							2255	4.37	18.5	84.9	10.3			3606
63		685	---	---	---	---	---	1.33	18.5	66.4	9.1	7260	74.2	1099
			870	---	---	---	---	1.69	18.5	71.4	9.1			1389
				1050	---	---	---	2.04	18.6	74.7	9.1			1678
					1500	---	---	2.92	18.6	80.2	9.1			2402
						1680	---	3.27	18.6	81.7	9.1			2692
							1955	3.80	18.6	83.5	9.1			3126

Nota (\*) - VENTILAZIONE SOLO L.O. / FAN ONLY SIDE COMMUTATOR

Nota (°) - Regolazione di campo / Field weakening



Potenza eccitazione Excitation power	(w)	290	Tipo		
Cost. tempo eccitaz. Field time constant	(ms)	145	Size	MGL	80 L
Massa del motore Mass of the motor	(Kg)	53	Ventilazione	IC 06	
Momento d'inerzia rotore Rotor inertia moment	(Kgm2)	0.011			

Avv.	Velocità nominale n/min a tensione nominale di armatura Rated speed (rev/min) at rated voltage							Potenza Power kW	Coppia vel.nomin. Torque at rated speed Nm	Rendimento Efficiency %	Circuito di armatura Armature circuit			Max giri Max. speed (°)
	170	220	260	300	400	440	500				Corrente Current Amp	Res. 115°C mOhm	Ind. mH	
64			720	---	---	---	---	1.41	18.7	67.8	8.0	9440	97.9	1151
				875	---	---	---	1.72	18.8	71.7	8.0			1404
					1270	---	---	2.49	18.7	77.8	8.0			2035
						1430	---	2.80	18.7	79.5	8.0			2287
							1665	3.27	18.8	81.8	8.0			2666
65			640	---	---	---	---	1.27	18.9	65.1	7.5	11000	113	1027
				790	---	---	---	1.56	18.9	69.3	7.5			1262
					1155	---	---	2.29	18.9	76.3	7.5			1848
						1300	---	2.58	19.0	78.2	7.5			2082
							1520	3.01	18.9	80.3	7.5			2434
66			590	---	---	---	---	1.18	19.1	63.9	7.1	12100	130	940
				725	---	---	---	1.45	19.1	68.1	7.1			1159
					1065	---	---	2.14	19.2	75.4	7.1			1706
						1205	---	2.42	19.2	77.5	7.1			1925
							1410	2.83	19.2	79.7	7.1			2253
67				655	---	---	---	1.3	19.0	65.7	6.6	14200	149	1048
					975	---	---	1.94	19.0	73.5	6.6			1561
						1105	---	2.20	19.0	75.8	6.6			1766
							1295	2.58	19.0	78.2	6.6			2074
68				600	---	---	---	1.20	19.1	64.5	6.2	15900	170	963
					905	---	---	1.79	18.9	72.2	6.2			1445
						1025	---	2.03	18.9	74.4	6.2			1638
							1205	2.39	18.9	77.1	6.2			1928
69					780	---	---	1.56	19.1	69.6	5.6	19500	212	1246
						885	---	1.78	19.2	72.2	5.6			1419
							1050	2.10	19.1	75.0	5.6			1678
70					670	---	---	1.33	19.0	66.5	5.0	24600	257	1075
						770	---	1.52	18.9	69.1	5.0			1231
							915	1.81	18.9	72.4	5.0			1466

Nota (\*) - VENTILAZIONE SOLO L.O. / FAN ONLY SIDE COMMUTATOR

Nota (°) - Regolazione di campo / Field weakening



Potenza eccitazione Excitation power	(w)	290	Tipo Size			MGL	80	L
Cost. tempo eccitaz. Field time constant	(ms)	145	Ventilazione Ventilation			IC 06		
Massa del motore Mass of the motor	(Kg)	53						
Momento d'inerzia rotore Rotor inertia moment	(Kgm2)	0.011						

Avv.	Velocità nominale n/min a tensione nominale di armatura Rated speed (rev/min) at rated voltage							Potenza Power	Coppia vel.nomin. Torque at rated speed Nm	Rendimento Efficiency	Circuito di armatura Armature circuit			Max giri Max. speed
	170	220	260	300	400	440	500	kW	%	Corrente Current Amp	Res. 115°C mOhm	Ind. mH	(°)	
71					585	---	---	1.12	18.3	63.6	4.4	30700	305	937
						675	---	1.29	18.2	66.6	4.4			1079
							810	1.54	18.2	70.0	4.4			1293
72												33600	365	
						610	---	1.21	18.9	65.5	4.2			974
							730	1.45	19.0	69.0	4.2			1171

Nota (\*) - VENTILAZIONE SOLO L.O. / FAN ONLY SIDE COMMUTATOR

Nota (°) - Regolazione di campo / Field weakening



Potenza eccitazione Excitation power	(w)	350	Tipo Size MGL 100 S Ventilazione Ventilation IC 06
Cost. tempo eccitaz. Field time constant	(ms)	140	
Massa del motore Mass of the motor	(Kg)	64.0	
Momento d'inerzia rotore Rotor inertia moment	(Kgm2)	0.019	

Avv.	Velocità nominale n/min a tensione nominale di armatura Rated speed (rev/min) at rated voltage							Potenza Power kW	Coppia vel.nomin. Torque at rated speed Nm	Rendimento Efficiency %	Circuito di armatura Armature circuit			Max giri Max. speed (°)
	170	220	260	300	400	440	500				Corrente Current Amp	Res. 115°C mOhm	Ind. mH	
45	3965	---	---	---	---	---	---	6.31	15.2	88.4	42.0	227	1.55	4700
46	3260	---	---	---	---	---	---	6.28	18.4	88.0	42.0	274	2.25	4700 4700
		4305	---	---	---	---	---	8.29	18.4	89.7	42.0			
47	2745	---	---	---	---	---	---	6.20	21.6	86.8	42.0	345	3.14	4389 4700 4700
		3635	---	---	---	---	---	8.22	21.6	89.0	42.0			
		4350	---	---	---	---	---	9.84	21.6	90.1	42.0			
48	2340	---	---	---	---	---	---	6.07	24.8	85.0	42.0	439	4.12	3741 4700 4700 4700
		3120	---	---	---	---	---	8.09	24.8	87.6	42.0			
		3745	---	---	---	---	---	9.72	24.8	89.0	42.0			
		4370	---	---	---	---	---	11.3	24.7	89.7	42.0			
49	2025	---	---	---	---	---	---	5.92	27.9	82.9	42.0	534	5.27	3236 4349 4700 4700
		2720	---	---	---	---	---	7.96	27.9	86.1	42.0			
		3275	---	---	---	---	---	9.59	28.0	87.8	42.0			
		3830	---	---	---	---	---	11.2	27.9	88.9	42.0			
50	1775	---	---	---	---	---	---	5.30	28.5	81.0	38.5	676	6.50	2841 3842 4643 4700 4700
		2400	---	---	---	---	---	7.19	28.6	84.9	38.5			
		2900	---	---	---	---	---	8.66	28.5	86.5	38.5			
		3400	---	---	---	---	---	10.1	28.4	87.4	38.5			
		4655	---	---	---	---	---	13.9	28.5	90.3	38.5			
51	1575	---	---	---	---	---	---	4.71	28.6	79.2	35.0	837	7.79	2523 3433 4162 4700 4700 4700
		2145	---	---	---	---	---	6.40	28.5	83.1	35.0			
		2600	---	---	---	---	---	7.76	28.5	85.3	35.0			
		3055	---	---	---	---	---	9.12	28.5	86.9	35.0			
		4195	---	---	---	---	---	12.5	28.5	89.3	35.0			
		4650	---	---	---	---	---	13.9	28.5	90.3	35.0			

Nota (\*) - VENTILAZIONE SOLO L.O. / FAN ONLY SIDE COMMUTATOR

Nota (°) - Regolazione di campo / Field weakening



Potenza eccitazione Excitation power	(w)	350	Tipo Size MGL 100 S Ventilazione Ventilation IC 06
Cost. tempo eccitaz. Field time constant	(ms)	140	
Massa del motore Mass of the motor	(Kg)	64.0	
Momento d'inerzia rotore Rotor inertia moment	(Kgm2)	0.019	

Avv.	Velocità nominale n/min a tensione nominale di armatura Rated speed (rev/min) at rated voltage							Potenza Power kW	Coppia vel.nomin. Torque at rated speed Nm	Rendimento Efficiency %	Circuito di armatura Armature circuit			Max giri Max. speed (°)	
	170	220	260	300	400	440	500				Corrente Current Amp	Res. 115°C mOhm	Ind. mH		
52	1435	---	---	---	---	---	---	4.27	28.4	78.5	32.0	946	9.23	2296	
		1955	---	---	---	---	---	5.82	28.4	82.7	32.0				3131
		2375	---	---	---	---	---	7.06	28.4	84.9	32.0				3798
			2790	---	---	---	---	8.30	28.4	86.5	32.0				4466
			3835	---	---	---	---	11.4	28.4	89.1	32.0				4700
				4250	---	---	---	12.6	28.3	89.5	32.0				4700
			53	1290	---	---	---	---	---	---	3.77				27.9
1770	---	---			---	---	---	5.18	27.9	81.2	29.0	2835			
2155	---	---			---	---	---	6.30	27.9	83.6	29.0	3452			
	2540	---			---	---	---	7.43	27.9	85.4	29.0	4068			
	3505	---			---	---	---	10.2	27.8	87.9	29.0	4700			
		3890			---	---	---	11.4	28.0	89.3	29.0	4700			
	4470	---			---	---	13.0	27.8	89.7	29.0	4700				
54	1185	---	---	---	---	---	---	3.54	28.5	75.7	27.5	1290	12.8	1894	
		1630	---	---	---	---	---	4.87	28.5	80.5	27.5				2609
		1990	---	---	---	---	---	5.94	28.5	83.1	27.5				3181
			2345	---	---	---	---	7.01	28.5	85.0	27.5				3753
			3240	---	---	---	---	9.68	28.5	88.0	27.5				4700
				3595	---	---	---	10.8	28.7	89.3	27.5				4700
			4135	---	---	---	12.3	28.4	89.5	27.5	4700				
55	1080	---	---	---	---	---	---	3.21	28.4	74.0	25.5	1510	14.4	1728	
		1495	---	---	---	---	---	4.44	28.4	79.1	25.5				2396
		1830	---	---	---	---	---	5.44	28.4	82.1	25.5				2930
			2165	---	---	---	---	6.43	28.4	84.1	25.5				3464
			3000	---	---	---	---	8.90	28.3	87.3	25.5				4700
				3335	---	---	---	9.89	28.3	88.1	25.5				4700
			3835	---	---	---	11.4	28.4	89.4	25.5	4700				
56	985	---	---	---	---	---	---	2.84	27.5	72.0	23.2	1800	16.5	1580	
		1380	---	---	---	---	---	3.97	27.5	77.8	23.2				2205
		1690	---	---	---	---	---	4.87	27.5	80.7	23.2				2706
			2005	---	---	---	---	5.77	27.5	82.9	23.2				3207
			2785	---	---	---	---	8.02	27.5	86.4	23.2				4458
				3100	---	---	---	8.92	27.5	87.4	23.2				4700
			3570	---	---	---	10.3	27.6	88.8	23.2	4700				
57	915	---	---	---	---	---	---	2.74	28.6	71.3	22.6	1920	18.8	1468	
		1285	---	---	---	---	---	3.83	28.5	77.0	22.6				2056
		1580	---	---	---	---	---	4.71	28.5	80.2	22.6				2528
			1875	---	---	---	---	5.59	28.5	82.4	22.6				2999
			2610	---	---	---	---	7.79	28.5	86.2	22.6				4177
				2905	---	---	---	8.66	28.5	87.1	22.6				4648
			3345	---	---	---	9.98	28.5	88.3	22.6	4700				
58	840	---	---	---	---	---	---	2.44	27.7	69.0	20.80	2250	20.7	1346	
		1190	---	---	---	---	---	3.45	27.7	75.4	20.80				1902
		1465	---	---	---	---	---	4.26	27.8	78.8	20.80				2347
			1745	---	---	---	---	5.07	27.7	81.3	20.80				2792
			2440	---	---	---	---	7.09	27.7	85.2	20.80				3905
				2720	---	---	---	7.90	27.7	86.3	20.80				4350
			3135	---	---	---	9.11	27.7	87.6	20.80	4700				

Nota (\*) - VENTILAZIONE SOLO L.O. / FAN ONLY SIDE COMMUTATOR

Nota (°) - Regolazione di campo / Field weakening



Potenza eccitazione Excitation power (w)	350	Tipo		
Cost. tempo eccitaz. Field time constant (ms)	140	Size	MGL	100 S
Massa del motore Mass of the motor (Kg)	64.0	Ventilazione Ventilation	IC 06	
Momento d'inerzia rotore Rotor inertia moment (Kgm2)	0.019			

Avv.	Velocità nominale n/min a tensione nominale di armatura Rated speed (rev/min) at rated voltage							Potenza Power kW	Coppia vel. nomin. Torque at rated speed Nm	Rendimento Efficiency %	Circuito di armatura Armature circuit			Max giri Max. speed (°)	
	170	220	260	300	400	440	500				Corrente Current Amp	Res. 115°C mOhm	Ind. mH		
59	785	---	---	---	---	---	---	2.34	28.5	68.1	20.2	2400	23.4	1260	
		1115	---	---	---	---	---	3.33	28.5	74.9	20.2				1786
		1380	---	---	---	---	---	4.11	28.4	78.3	20.2				2208
			1645	---	---	---	---	4.90	28.4	80.9	20.2				2630
			2300	---	---	---	---	6.86	28.5	84.9	20.2				3684
				2565	---	---	---	7.64	28.4	86.0	20.2				4105
			2960	---	---	---	8.82	28.5	87.3	20.2	4700				
60	720	---	---	---	---	---	---	2.11	28.0	66.0	18.8	2790	25.7	1155	
		1035	---	---	---	---	---	3.02	27.9	73.0	18.8				1656
		1285	---	---	---	---	---	3.75	27.9	76.7	18.8				2056
			1535	---	---	---	---	4.48	27.9	79.4	18.8				2457
			2160	---	---	---	---	6.30	27.9	83.8	18.8				3458
				2410	---	---	---	7.03	27.9	85.0	18.8				3858
			2785	---	---	---	8.13	27.9	86.5	18.8	4459				
61	680	---	---	---	---	---	---	2.02	28.4	65.3	18.2	2950	28.6	1088	
		980	---	---	---	---	---	2.90	28.3	72.4	18.2				1565
		1215	---	---	---	---	---	3.61	28.4	76.3	18.2				1947
			1455	---	---	---	---	4.32	28.4	79.1	18.2				2328
			2050	---	---	---	---	6.08	28.3	83.5	18.2				3282
				2290	---	---	---	6.79	28.3	84.8	18.2				3663
			2645	---	---	---	7.85	28.3	86.3	18.2	4235				
62	635	---	---	---	---	---	---	1.90	28.6	63.9	17.5	3210	31.3	1017	
		920	---	---	---	---	---	2.75	28.5	71.4	17.5				1472
		1145	---	---	---	---	---	3.43	28.6	75.4	17.5				1836
			1375	---	---	---	---	4.10	28.5	78.1	17.5				2200
			1945	---	---	---	---	5.81	28.5	83.0	17.5				3110
				2170	---	---	---	6.49	28.6	84.3	17.5				3474
			2515	---	---	---	7.51	28.5	85.8	17.5	4020				
63	865	---	---	---	---	---	---	2.53	27.9	70.1	16.4	3610	34.1	1382	
		1080	---	---	---	---	---	3.16	27.9	74.1	16.4				1730
		1300	---	---	---	---	---	3.80	27.9	77.2	16.4				2078
			1845	---	---	---	---	5.39	27.9	82.2	16.4				2949
			2060	---	---	---	---	6.03	28.0	83.6	16.4				3297
				2385	---	---	---	6.99	28.0	85.2	16.4				3819
			64	765	---	---	---	---	---	---	2.26				28.2
965	---	---			---	---	---	2.85	28.2	72.1	15.2	1546			
1165	---	---			---	---	---	3.44	28.2	75.4	15.2	1866			
	1665	---			---	---	---	4.92	28.2	80.9	15.2	2667			
	1865	---			---	---	---	5.51	28.2	82.4	15.2	2987			
		2165			---	---	---	6.39	28.2	84.1	15.2	3468			
	65	680			---	---	---	---	---	---	1.99	27.9	64.6	14.0	5110
865			---	---	---	---	---	2.53	27.9	69.5	14.0	1382			
1050			---	---	---	---	---	3.08	28.0	73.3	14.0	1678			
			1515	---	---	---	---	4.44	28.0	79.3	14.0	2420			
			1700	---	---	---	---	4.98	28.0	80.8	14.0	2717			
				1975	---	---	---	5.80	28.0	82.9	14.0	3162			

Nota (\*) - VENTILAZIONE SOLO L.O. / FAN ONLY SIDE COMMUTATOR

Nota (°) - Regolazione di campo / Field weakening





Potenza eccitazione Excitation power	(w)	350	Tipo Size MGL 100 S Ventilazione Ventilation IC 06
Cost. tempo eccitaz. Field time constant	(ms)	140	
Massa del motore Mass of the motor	(Kg)	64.0	
Momento d'inerzia rotore Rotor inertia moment	(Kgm2)	0.019	

Avv.	Velocità nominale n/min a tensione nominale di armatura Rated speed (rev/min) at rated voltage							Potenza Power kW	Coppia vel.nomin. Torque at rated speed Nm	Rendimento Efficiency %	Circuito di armatura Armature circuit			Max giri Max. speed (°)	
	170	220	260	300	400	440	500				Corrente Current Amp	Res. 115°C mOhm	Ind. mH		
66		625	---	---	---	---	---	1.86	28.4	64.0	13.2	5510	54.7	1002	
			800	---	---	---	---	2.37	28.3	69.1	13.2				1278
			970	---	---	---	---	2.89	28.5	73.0	13.2				1554
			1405	---	---	---	---	4.17	28.3	79.0	13.2				2245
			1575	---	---	---	---	4.68	28.4	80.6	13.2				2521
			1835	---	---	---	---	5.45	28.4	82.6	13.2				2935
67			715	---	---	---	---	2.10	28.0	66.2	12.2	6610	62.0	1145	
				875	---	---	---	2.57	28.0	70.2	12.2				1404
				1280	---	---	---	3.76	28.1	77.0	12.2				2049
				1440	---	---	---	4.23	28.1	78.8	12.2				2308
				1680	---	---	---	4.94	28.1	81.0	12.2				2695
68			665	---	---	---	---	2.01	28.9	65.5	11.8	7020	70.4	1063	
				815	---	---	---	2.47	28.9	69.8	11.8				1305
				1195	---	---	---	3.61	28.8	76.5	11.8				1912
				1345	---	---	---	4.07	28.9	78.4	11.8				2155
				1575	---	---	---	4.76	28.9	80.7	11.8				2519
69				740	---	---	---	2.17	28.0	67.0	10.8	8390	79.2	1186	
					1100	---	---	3.22	28.0	74.5	10.8				1758
					1240	---	---	3.64	28.0	76.6	10.8				1987
					1455	---	---	4.27	28.0	79.1	10.8				2330
70				650	---	---	---	1.88	27.6	63.9	9.8	10200	93.4	1041	
					980	---	---	2.83	27.6	72.2	9.8				1568
					1110	---	---	3.21	27.6	74.4	9.8				1778
					1310	---	---	3.78	27.6	77.1	9.8				2095
71					855	---	---	2.62	29.3	69.7	9.4	11800	114	1366	
				975		---	---	2.99	29.3	72.3	9.4				1557
				1150		---	---	3.53	29.3	75.1	9.4				1843
72				790	---	---	---	2.37	28.6	68.9	8.60	13300	132	1261	
					900	---	---	2.70	28.6	71.4	8.60				1439
					1065	---	---	3.20	28.7	74.4	8.60				1706

Nota (\*) - VENTILAZIONE SOLO L.O. / FAN ONLY SIDE COMMUTATOR

Nota (°) - Regolazione di campo / Field weakening



Potenza eccitazione Excitation power	(w)	350	Tipo Size Ventilazione Ventilation	MGL 100 S IC 06
Cost. tempo eccitaz. Field time constant	(ms)	140		
Massa del motore Mass of the motor	(Kg)	64.0		
Momento d'inerzia rotore Rotor inertia moment	(Kgm2)	0.019		

Avv.	Velocità nominale n/min a tensione nominale di armatura Rated speed (rev/min) at rated voltage							Potenza Power	Coppia vel.nomin. Torque at rated speed Nm	Rendimento Efficiency	Circuito di armatura Armature circuit			Max giri Max. speed (°)	
	170	220	260	300	400	440	500	kW	%	Corrente Current Amp	Res. 115°C mOhm	Ind. mH			
73					725	---	---	2.19	28.8	67.6	8.1	14800	151	1161	
					830	---	---	2.51	28.9	70.4	8.1				1328
					985	---	---	2.98	28.9	73.6	8.1				1578
74					660	---	---	1.94	28.1	65.5	7.4	17400	169	1058	
					760	---	---	2.22	27.9	68.2	7.4				1215
					905	---	---	2.66	28.1	71.9	7.4				1450

Nota (\*) - VENTILAZIONE SOLO L.O. / FAN ONLY SIDE COMMUTATOR

Nota (°) - Regolazione di campo / Field weakening



Potenza eccitazione Excitation power	(w)	380	Tipo Size MGL 100 M Ventilazione Ventilation IC 06
Cost. tempo eccitaz. Field time constant	(ms)	165	
Massa del motore Mass of the motor	(Kg)	72	
Momento d'inerzia rotore Rotor inertia moment	(Kgm <sup>2</sup> )	0.023	

Avv.	Velocità nominale n/min a tensione nominale di armatura Rated speed (rev/min) at rated voltage							Potenza Power kW	Coppia vel.nomin. Torque at rated speed Nm	Rendimento Efficiency %	Circuito di armatura Armature circuit			Max giri Max. speed (°)
	170	220	260	300	400	440	500				Corrente Current Amp	Res. 115°C mOhm	Ind. mH	
45	3290	---	---	---	---	---	---	6.32	18.3	88.5	42	250	1.87	4700
		4335	---	---	---	---	---	8.33	18.3	90.2	42			
46	2705	---	---	---	---	---	---	6.28	22.2	88.0	42	302	2.73	4324
		3575	---	---	---	---	---	8.30	22.2	89.8	42			
		4270	---	---	---	---	---	9.92	22.2	90.8	42			
47	2270	---	---	---	---	---	---	6.18	26.0	86.6	42	379	3.80	3629
		3015	---	---	---	---	---	8.21	26.0	88.9	42			
		3610	---	---	---	---	---	9.83	26.0	90.0	42			
		4210	---	---	---	---	---	11.5	26.1	91.3	42			
48	1930	---	---	---	---	---	---	6.02	29.8	84.3	42	483	4.99	3084
		2580	---	---	---	---	---	8.06	29.8	87.2	42			
		3105	---	---	---	---	---	9.69	29.8	88.7	42			
		3625	---	---	---	---	---	11.3	29.8	89.7	42			
49	1665	---	---	---	---	---	---	5.86	33.6	82.1	42	586	6.39	2661
		2245	---	---	---	---	---	7.90	33.6	85.5	42			
		2710	---	---	---	---	---	9.54	33.6	87.4	42			
		3170	---	---	---	---	---	11.2	33.7	88.9	42			
		4335	---	---	---	---	---	15.3	33.7	91.1	42			
50	1455	---	---	---	---	---	---	5.22	34.3	79.8	38.5	742	7.88	2329
		1980	---	---	---	---	---	7.10	34.2	83.8	38.5			
		2395	---	---	---	---	---	8.60	34.3	85.9	38.5			
		2815	---	---	---	---	---	10.1	34.3	87.4	38.5			
		3860	---	---	---	---	---	13.8	34.1	89.6	38.5			
		4275	---	---	---	---	---	15.3	34.2	90.3	38.5			
		---	---	---	---	---	---	---	---	---	---			
51	1290	---	---	---	---	---	---	4.63	34.3	77.8	35	919	9.44	1820
		1765	---	---	---	---	---	6.33	34.2	82.2	35			
		2145	---	---	---	---	---	7.70	34.3	84.6	35			
		2525	---	---	---	---	---	9.06	34.3	86.3	35			
		3475	---	---	---	---	---	12.5	34.4	89.3	35			
		3855	---	---	---	---	---	13.8	34.2	89.6	35			
		---	---	---	---	---	---	---	---	---	---			
		4425	---	---	---	---	---	15.9	34.3	90.9	35			

Nota (\*) - VENTILAZIONE SOLO L.O. / FAN ONLY SIDE COMMUTATOR

Nota (°) - Regolazione di campo / Field weakening



Potenza eccitazione Excitation power	(w)	380	Tipo Size	MGL	100	M
Cost. tempo eccitaz. Field time constant	(ms)	165				
Massa del motore Mass of the motor	(Kg)	72	Ventilazione Ventilation			IC 06
Momento d'inerzia rotore Rotor inertia moment	(Kgm2)	0.023				

Avv.	Velocità nominale n/min a tensione nominale di armatura Rated speed (rev/min) at rated voltage							Potenza Power kW	Coppia vel.nomin. Torque at rated speed Nm	Rendimento Efficiency %	Circuito di armatura Armature circuit			Max giri Max. speed (°)
	170	220	260	300	400	440	500				Corrente Current Amp	Res. 115°C mOhm	Ind. mH	
52	1170	---	---	---	---	---	---	4.19	34.2	77.0	32	1040	11.2	1875
		1605	---	---	---	---	---	5.75	34.2	81.7	32			2571
		---	1955	---	---	---	---	7.00	34.2	84.1	32			3128
		---	---	2305	---	---	---	8.25	34.2	85.9	32			3685
		---	---	---	3175	---	---	11.4	34.3	89.1	32			4700
		---	---	---	---	3520	---	12.6	34.2	89.5	32			4700
		---	---	---	---	---	4045	14.5	34.2	90.6	32			4700
53	1050	---	---	---	---	---	---	3.69	33.6	74.8	29	1280	13.2	1281
		1450	---	---	---	---	---	5.10	33.6	79.9	29			2324
		---	1775	---	---	---	---	6.23	33.5	82.6	29			2838
		---	---	2095	---	---	---	7.36	33.5	84.6	29			3352
		---	---	---	2900	---	---	10.2	33.6	87.9	29			4638
		---	---	---	---	3220	---	11.3	33.5	88.6	29			4700
		---	---	---	---	---	3700	13.0	33.6	89.7	29			4700
54	960	---	---	---	---	---	---	3.46	34.4	74.0	27.5	1420	15.5	1539
		1335	---	---	---	---	---	4.80	34.3	79.3	27.5			2136
		---	1635	---	---	---	---	5.87	34.3	82.1	27.5			2614
		---	---	1930	---	---	---	6.94	34.3	84.1	27.5			3091
		---	---	---	2680	---	---	9.62	34.3	87.5	27.5			4285
		---	---	---	---	2975	---	10.7	34.3	88.4	27.5			4700
		---	---	---	---	---	3425	12.3	34.3	89.5	27.5			4700
55	875	---	---	---	---	---	---	3.12	34.1	72.0	25.5	1660	17.4	1400
		1225	---	---	---	---	---	4.37	34.1	77.9	25.5			1957
		---	1500	---	---	---	---	5.36	34.1	80.8	25.5			2403
		---	---	1780	---	---	---	6.36	34.1	83.1	25.5			2849
		---	---	---	2475	---	---	8.84	34.1	86.7	25.5			3963
		---	---	---	---	2755	---	9.84	34.1	87.7	25.5			4409
		---	---	---	---	---	3175	11.3	34.0	88.6	25.5			4700
56	795	---	---	---	---	---	---	2.76	33.2	70.0	23.2	1970	20.0	1275
		1125	---	---	---	---	---	3.89	33.0	76.2	23.2			1798
		---	1385	---	---	---	---	4.80	33.1	79.6	23.2			2216
		---	---	1645	---	---	---	5.70	33.1	81.9	23.2			2634
		---	---	---	2300	---	---	7.96	33.0	85.8	23.2			3678
		---	---	---	---	2560	---	8.87	33.1	86.9	23.2			4096
		---	---	---	---	---	2950	10.2	33.0	87.9	23.2			4700
57	740	---	---	---	---	---	---	2.65	34.2	69.0	22.6	2100	22.8	1183
		1045	---	---	---	---	---	3.76	34.4	75.6	22.6			1675
		---	1290	---	---	---	---	4.64	34.3	79.0	22.6			2068
		---	---	1540	---	---	---	5.52	34.2	81.4	22.6			2461
		---	---	---	2155	---	---	7.72	34.2	85.4	22.6			3444
		---	---	---	---	2400	---	8.61	34.3	86.6	22.6			3838
		---	---	---	---	---	2765	9.93	34.3	87.9	22.6			4428
58	675	---	---	---	---	---	---	2.36	33.4	66.7	20.8	2480	25.1	1081
		965	---	---	---	---	---	3.37	33.3	73.6	20.8			1545
		---	1200	---	---	---	---	4.18	33.3	77.3	20.8			1916
		---	---	1430	---	---	---	5.00	33.4	80.1	20.8			2288
		---	---	---	2010	---	---	7.02	33.4	84.4	20.8			3216
		---	---	---	---	2240	---	7.83	33.4	85.6	20.8			3588
		---	---	---	---	---	2590	9.05	33.4	87.0	20.8			4145

Nota (\*) - VENTILAZIONE SOLO L.O. / FAN ONLY SIDE COMMUTATOR

Nota (°) - Regolazione di campo / Field weakening



Potenza eccitazione Excitation power	(w)	380	Tipo Size	MGL	100	M
Cost. tempo eccitaz. Field time constant	(ms)	165	Ventilazione Ventilation	IC 06		
Massa del motore Mass of the motor	(Kg)	72				
Momento d'inerzia rotore Rotor inertia moment	(Kgm2)	0.023				

Avv.	Velocità nominale n/min a tensione nominale di armatura Rated speed (rev/min) at rated voltage							Potenza Power kW	Coppia vel.nomin. Torque at rated speed Nm	Rendimento Efficiency %	Circuito di armatura Armature circuit			Max giri Max. speed (°)	
	170	220	260	300	400	440	500				Corrente Current Amp	Res. 115°C mOhm	Ind. mH		
59	630	---	---	---	---	---	---	2.26	34.3	65.8	20.2	2630	28.3	1009	
		905	---	---	---	---	---	3.25	34.3	73.1	20.2				1449
		---	1125	---	---	---	---	4.03	34.2	76.7	20.2				1801
		---	---	1345	---	---	---	4.82	34.2	79.5	20.2				2153
		---	---	---	1895	---	---	6.79	34.2	84.0	20.2				3033
		---	---	---	---	2115	---	7.58	34.2	85.3	20.2				3385
		---	---	---	---	---	2445	8.76	34.2	86.7	20.2				3912
60	835	---	---	---	---	---	---	2.94	33.6	71.1	18.8	3070	31.1	1338	
		1045	---	---	---	---	---	3.67	33.5	75.1	18.8				1673
		---	1255	---	---	---	---	4.40	33.5	78.0	18.8				2007
		---	---	1775	---	---	---	6.23	33.5	82.8	18.8				2843
		---	---	---	1985	---	---	6.97	33.5	84.3	18.8				3177
		---	---	---	---	2300	---	8.07	33.5	85.9	18.8				3678
		---	---	---	---	---	---	---	---	---	---				---
61	790	---	---	---	---	---	---	2.82	34.1	70.4	18.2	3240	34.7	1264	
		990	---	---	---	---	---	3.53	34.0	74.6	18.2				1583
		---	1190	---	---	---	---	4.24	34.0	77.7	18.2				1901
		---	---	1685	---	---	---	6.01	34.1	82.6	18.2				2697
		---	---	---	1885	---	---	6.72	34.0	83.9	18.2				3015
		---	---	---	---	2185	---	7.79	34.0	85.6	18.2				3493
		---	---	---	---	---	---	---	---	---	---				---
62	740	---	---	---	---	---	---	2.67	34.5	69.4	17.5	3530	37.9	1186	
		930	---	---	---	---	---	3.35	34.4	73.6	17.5				1490
		---	1120	---	---	---	---	4.03	34.4	76.8	17.5				1794
		---	---	1595	---	---	---	5.74	34.4	82.0	17.5				2554
		---	---	---	1785	---	---	6.42	34.3	83.4	17.5				2858
		---	---	---	---	2070	---	7.44	34.3	85.0	17.5				3314
		---	---	---	---	---	---	---	---	---	---				---
63	695	---	---	---	---	---	---	2.44	33.5	67.6	16.4	3970	41.3	1111	
		875	---	---	---	---	---	3.08	33.6	72.2	16.4				1401
		---	1055	---	---	---	---	3.72	33.7	75.6	16.4				1692
		---	---	1510	---	---	---	5.32	33.6	81.1	16.4				2419
		---	---	---	1695	---	---	5.96	33.6	82.6	16.4				2709
		---	---	---	---	1965	---	6.92	33.6	84.4	16.4				3145
		---	---	---	---	---	---	---	---	---	---				---
64	615	---	---	---	---	---	---	2.17	33.7	64.9	15.2	4690	49.0	980	
		780	---	---	---	---	---	2.77	33.9	70.1	15.2				1248
		---	945	---	---	---	---	3.36	34.0	73.7	15.2				1515
		---	---	1365	---	---	---	4.84	33.9	79.6	15.2				2184
		---	---	---	1530	---	---	5.43	33.9	81.2	15.2				2451
		---	---	---	---	1785	---	6.32	33.8	83.2	15.2				2852
		---	---	---	---	---	---	---	---	---	---				---
65	695	---	---	---	---	---	---	2.45	33.7	67.3	14	5610	56.9	1110	
		850	---	---	---	---	---	2.99	33.6	71.2	14				1358
		---	---	---	---	---	---	4.36	33.7	77.9	14				1977
		---	---	1235	---	---	---	4.90	33.7	79.5	14				2224
		---	---	---	1390	---	---	5.72	33.7	81.7	14				2596
		---	---	---	---	1620	---	---	---	---	---				---
		---	---	---	---	---	---	---	---	---	---				---

Nota (\*) - VENTILAZIONE SOLO L.O. / FAN ONLY SIDE COMMUTATOR

Nota (°) - Regolazione di campo / Field weakening



Potenza eccitazione Excitation power	(w)	380	Tipo Size MGL 100 M Ventilazione Ventilation IC 06
Cost. tempo eccitaz. Field time constant	(ms)	165	
Massa del motore Mass of the motor	(Kg)	72	
Momento d'inerzia rotore Rotor inertia moment	(Kgm <sup>2</sup> )	0.023	

Avv.	Velocità nominale n/min a tensione nominale di armatura Rated speed (rev/min) at rated voltage							Potenza Power kW	Coppia vel.nomin. Torque at rated speed Nm	Rendimento Efficiency %	Circuito di armatura Armature circuit			Max giri Max. speed (°)
	170	220	260	300	400	440	500				Corrente Current Amp	Res. 115°C mOhm	Ind. mH	
66			640	---	---	---	---	2.29	34.2	66.7	13.2	6050	66.3	1026
				785	---	---	---	2.81	34.2	71.0	13.2			1257
					1145	---	---	4.09	34.1	77.5	13.2			1833
						1290	---	4.61	34.1	79.4	13.2			2063
						1505	---	5.38	34.1	81.5	13.2			2409
67			570	---	---	---	---	2.01	33.7	63.4	12.2	7260	75.1	913
				705	---	---	---	2.49	33.7	68.0	12.2			1129
					1045	---	---	3.68	33.6	75.4	12.2			1668
						1175	---	4.16	33.8	77.5	12.2			1884
						1380	---	4.87	33.7	79.8	12.2			2207
68				655	---	---	---	2.38	34.7	67.2	11.8	7700	85.3	1049
					970	---	---	3.53	34.8	74.8	11.8			1555
						1100	---	3.99	34.6	76.8	11.8			1758
						1290	---	4.69	34.7	79.5	11.8			2062
69				590	---	---	---	2.09	33.8	64.5	10.8	9210	95.9	947
					890	---	---	3.14	33.7	72.7	10.8			1425
						1010	---	3.56	33.7	74.9	10.8			1616
						1190	---	4.20	33.7	77.8	10.8			1903
70				790	---	---	---	2.75	33.2	70.2	9.8	11300	113	1265
					900	---	---	3.13	33.2	72.6	9.8			1441
						1065	---	3.70	33.2	75.5	9.8			1705
71				685	---	---	---	2.53	35.3	67.3	9.4	13000	139	1097
					785	---	---	2.90	35.3	70.1	9.4			1256
						935	---	3.45	35.2	73.4	9.4			1495
72				630	---	---	---	2.28	34.6	66.3	8.6	14600	160	1011
					725	---	---	2.62	34.5	69.2	8.6			1160
						865	---	3.12	34.4	72.6	8.6			1382

Nota (\*) - VENTILAZIONE SOLO L.O. / FAN ONLY SIDE COMMUTATOR

Nota (°) - Regolazione di campo / Field weakening



Potenza eccitazione Excitation power	(w)	380	Tipo Size Ventilazione Ventilation	MGL 100 M IC 06
Cost. tempo eccitaz. Field time constant	(ms)	165		
Massa del motore Mass of the motor	(Kg)	72		
Momento d'inerzia rotore Rotor inertia moment	(Kgm2)	0.023		

Avv.	Velocità nominale n/min a tensione nominale di armatura Rated speed (rev/min) at rated voltage							Potenza Power	Coppia vel.nomin. Torque at rated speed Nm	Rendimento Efficiency	Circuito di armatura Armature circuit			Max giri Max. speed (°)
	170	220	260	300	400	440	500	kW	%	Corrente Current Amp	Res. 115°C mOhm	Ind. mH		
73					580	---	---	2.11 2.42 2.90	34.7 34.8 34.6	65.1 67.9 71.6	8.1 8.1 8.1	16200	183	929 1068 1277
74						610	---	2.14 2.58	33.5 33.7	65.7 69.7	7.4 7.4	19100	205	973 1170

Nota (\*) - VENTILAZIONE SOLO L.O. / FAN ONLY SIDE COMMUTATOR

Nota (°) - Regolazione di campo / Field weakening



Potenza eccitazione Excitation power	(w)	430	Tipo Size MGL 100 L Ventilazione Ventilation IC 06
Cost. tempo eccitaz. Field time constant	(ms)	180	
Massa del motore Mass of the motor	(Kg)	82	
Momento d'inerzia rotore Rotor inertia moment	(Kgm2)	0.028	

Avv.	Velocità nominale n/min a tensione nominale di armatura Rated speed (rev/min) at rated voltage							Potenza Power kW	Coppia vel.nomin. Torque at rated speed Nm	Rendimento Efficiency %	Circuito di armatura Armature circuit			Max giri Max. speed (°)	
	170	220	260	300	400	440	500				Corrente Current Amp	Res. 115°C mOhm	Ind. mH		
45	2525	---	---	---	---	---	---	6.32	23.9	88.5	42	283	2.33	4043	
		3335	---	---	---	---	---	8.35	23.9	90.4	42				4700
		3985	---	---	---	---	---	9.97	23.9	91.3	42				4700
			4635	---	---	---	---	11.6	23.9	92.1	42				4700
46	2075	---	---	---	---	---	---	6.26	28.8	87.7	42	341	3.39	3317	
		2750	---	---	---	---	---	8.30	28.8	89.8	42				4396
		3290	---	---	---	---	---	9.93	28.8	90.9	42				4700
			3830	---	---	---	---	11.6	28.9	92.1	42				4700
47	1735	---	---	---	---	---	---	6.13	33.7	85.9	42	427	4.73	2776	
		2315	---	---	---	---	---	8.18	33.7	88.5	42				3701
		2775	---	---	---	---	---	9.81	33.8	89.8	42				4442
			3240	---	---	---	---	11.4	33.6	90.5	42				4700
48	1470	---	---	---	---	---	---	5.95	38.7	83.3	42	543	6.21	2350	
		1975	---	---	---	---	---	8.00	38.7	86.6	42				3159
		2380	---	---	---	---	---	9.64	38.7	88.3	42				3807
			2785	---	---	---	---	11.3	38.7	89.7	42				4455
49	1260	---	---	---	---	---	---	5.76	43.7	80.7	42	586	7.95	2019	
		1710	---	---	---	---	---	7.82	43.7	84.6	42				2738
		2070	---	---	---	---	---	9.46	43.6	86.6	42				3314
			2430	---	---	---	---	11.1	43.6	88.1	42				3890
50	1100	---	---	---	---	---	---	5.12	44.4	78.2	38.5	835	9.8	1759	
		1505	---	---	---	---	---	7.00	44.4	82.6	38.5				2407
		1830	---	---	---	---	---	8.51	44.4	85.0	38.5				2925
			2150	---	---	---	---	10.0	44.4	86.6	38.5				3443
51	970	---	---	---	---	---	---	4.51	44.4	75.8	35	1030	11.7	1552	
		1340	---	---	---	---	---	6.23	44.4	80.9	35				2141
		1630	---	---	---	---	---	7.60	44.5	83.5	35				2612
			1925	---	---	---	---	8.97	44.5	85.4	35				3083
52	970	---	---	---	---	---	---	12.4	44.4	88.6	35	1030	11.7	4261	
		2665	---	---	---	---	---	13.8	44.6	89.6	35				4700
		2955	---	---	---	---	---	15.8	44.6	90.3	35				4700
			3400	---	---	---	---	15.8	44.4	90.3	35				4700

Nota (\*) - VENTILAZIONE SOLO L.O. / FAN ONLY SIDE COMMUTATOR

Nota (°) - Regolazione di campo / Field weakening





Potenza eccitazione Excitation power	(w)	430	Tipo	
Cost. tempo eccitaz. Field time constant	(ms)	180	Size	MGL 100 L
Massa del motore Mass of the motor	(Kg)	82	Ventilazione Ventilation	IC 06
Momento d'inerzia rotore Rotor inertia moment	(Kgm2)	0.028		

Avv.	Velocità nominale n/min a tensione nominale di armatura Rated speed (rev/min) at rated voltage							Potenza Power kW	Coppia vel.nomin. Torque at rated speed Nm	Rendimento Efficiency %	Circuito di armatura Armature circuit			Max giri Max. speed (°)
	170	220	260	300	400	440	500				Corrente Current Amp	Res. 115°C mOhm	Ind. mH	
52	880	---	---	---	---	---	---	4.08	44.3	75.0	32	1170	13.9	1408
		1215	---	---	---	---	---	5.65	44.4	80.3	32			1948
		---	1485	---	---	---	---	6.90	44.4	82.9	32			2380
		---	---	1755	---	---	---	8.15	44.3	84.9	32			2811
		---	---	---	2430	---	---	11.3	44.4	88.3	32			3891
		---	---	---	---	2700	---	12.5	44.2	88.8	32			4323
		---	---	---	---	---	3105	14.4	44.3	90.0	32			4700
53	785	---	---	---	---	---	---	3.58	43.5	72.6	29	1440	16.4	1256
		1095	---	---	---	---	---	5.00	43.6	78.4	29			1755
		---	1345	---	---	---	---	6.13	43.5	81.3	29			2153
		---	---	1595	---	---	---	7.27	43.5	83.6	29			2552
		---	---	---	2220	---	---	10.1	43.4	87.1	29			3549
		---	---	---	---	2465	---	11.2	43.4	87.8	29			3948
		---	---	---	---	---	2840	12.9	43.4	89.0	29			4546
54	720	---	---	---	---	---	---	3.34	44.3	71.4	27.5	1590	19.3	1148
		1005	---	---	---	---	---	4.69	44.6	77.5	27.5			1611
		---	1240	---	---	---	---	5.77	44.4	80.7	27.5			1981
		---	---	1470	---	---	---	6.84	44.4	82.9	27.5			2351
		---	---	---	2050	---	---	9.54	44.4	86.7	27.5			3277
		---	---	---	---	2280	---	10.6	44.4	87.6	27.5			3647
		---	---	---	---	---	2625	12.2	44.4	88.7	27.5			4202
55	650	---	---	---	---	---	---	3.01	44.2	69.4	25.5	1870	21.7	1039
		920	---	---	---	---	---	4.25	44.1	75.8	25.5			1471
		---	1135	---	---	---	---	5.25	44.2	79.2	25.5			1817
		---	---	1350	---	---	---	6.25	44.2	81.7	25.5			2162
		---	---	---	1890	---	---	8.75	44.2	85.8	25.5			3026
		---	---	---	---	2105	---	9.75	44.2	86.9	25.5			3372
		---	---	---	---	---	2430	11.2	44.0	87.8	25.5			3890
56	590	---	---	---	---	---	---	2.64	42.7	66.9	23.2	2220	24.8	942
		840	---	---	---	---	---	3.78	43.0	74.1	23.2			1347
		---	1045	---	---	---	---	4.69	42.9	77.8	23.2			1671
		---	---	1245	---	---	---	5.60	43.0	80.5	23.2			1995
		---	---	---	1755	---	---	7.87	42.8	84.8	23.2			2805
		---	---	---	---	1955	---	8.78	42.9	86.0	23.2			3129
		---	---	---	---	---	2260	10.1	42.7	87.1	23.2			3614
57	545	---	---	---	---	---	---	2.53	44.3	65.9	22.6	2370	28.3	872
		785	---	---	---	---	---	3.64	44.3	73.2	22.6			1253
		---	975	---	---	---	---	4.53	44.4	77.1	22.6			1558
		---	---	1165	---	---	---	5.41	44.3	79.8	22.6			1863
		---	---	---	1640	---	---	7.63	44.4	84.4	22.6			2625
		---	---	---	---	1830	---	8.51	44.4	85.6	22.6			2930
		---	---	---	---	---	2115	9.84	44.4	87.1	22.6			3387
58	720	---	---	---	---	---	---	3.26	43.2	71.2	20.8	2790	31.2	1151
		900	---	---	---	---	---	4.07	43.2	75.3	20.8			1439
		---	---	1080	---	---	---	4.89	43.2	78.4	20.8			1727
		---	---	---	1530	---	---	6.92	43.2	83.2	20.8			2446
		---	---	---	---	1710	---	7.74	43.2	84.6	20.8			2734
		---	---	---	---	---	1980	8.96	43.2	86.2	20.8			3166
		---	---	---	---	---	---	---	---	---	---			---

Nota (\*) - VENTILAZIONE SOLO L.O. / FAN ONLY SIDE COMMUTATOR

Nota (°) - Regolazione di campo / Field weakening



Potenza eccitazione Excitation power	(w)	430	Tipo Size MGL 100 L Ventilazione Ventilation IC 06
Cost. tempo eccitaz. Field time constant	(ms)	180	
Massa del motore Mass of the motor	(Kg)	82	
Momento d'inerzia rotore Rotor inertia moment	(Kgm2)	0.028	

Avv.	Velocità nominale n/min a tensione nominale di armatura Rated speed (rev/min) at rated voltage							Potenza Power kW	Coppia vel.nomin. Torque at rated speed Nm	Rendimento Efficiency %	Circuito di armatura Armature circuit			Max giri Max. speed (°)
	170	220	260	300	400	440	500				Corrente Current Amp	Res. 115°C mOhm	Ind. mH	
59		675	---	---	---	---	---	3.13	44.3	70.4	20.2	2960	35.2	1078
			845	---	---	---	---	3.92	44.3	74.6	20.2			1351
				1015	---	---	---	4.71	44.3	77.7	20.2			1623
					1440	---	---	6.69	44.4	82.8	20.2			2305
						1610	---	7.48	44.4	84.2	20.2			2578
							1865	8.67	44.4	85.8	20.2			2987
60		620	---	---	---	---	---	2.81	43.3	67.9	18.8	3460	38.7	990
			780	---	---	---	---	3.55	43.5	72.6	18.8			1250
				945	---	---	---	4.29	43.4	76.1	18.8			1509
					1350	---	---	6.13	43.4	81.5	18.8			257
						1510	---	6.87	43.4	83.1	18.8			2416
							1755	7.97	43.4	84.8	18.8			2804
61		585	---	---	---	---	---	2.70	44.1	67.4	18.2	3650	43.1	934
			740	---	---	---	---	3.41	44.0	72.1	18.2			1181
				895	---	---	---	4.13	44.1	75.6	18.2			1428
					1280	---	---	5.91	44.1	81.2	18.2			2045
						1430	---	6.62	44.2	82.7	18.2			2292
							1665	7.69	44.1	84.5	18.2			2662
62		545	---	---	---	---	---	2.54	44.5	66.0	17.5	3970	47.1	874
			695	---	---	---	---	3.23	44.4	71.0	17.5			1110
				840	---	---	---	3.92	44.6	74.7	17.5			1345
					1210	---	---	5.63	44.4	80.4	17.5			1934
						1355	---	6.32	44.5	82.1	17.5			2170
							1575	7.34	44.5	83.9	17.5			2523
63		510	---	---	---	---	---	2.32	43.4	64.3	16.4	4470	51.3	815
			650	---	---	---	---	2.97	43.6	69.7	16.4			1040
				790	---	---	---	3.61	43.6	73.4	16.4			1265
					1145	---	---	5.21	43.5	79.4	16.4			1829
						1285	---	5.86	43.5	81.2	16.4			2054
							1495	6.82	43.6	83.2	16.4			2392
64			575	---	---	---	---	2.65	44.0	67.1	15.2	5270	61.0	921
				705	---	---	---	3.24	43.9	71.1	15.2			1129
					1030	---	---	4.73	43.9	77.8	15.2			1647
						1160	---	5.33	43.9	79.7	15.2			1854
							1355	6.22	43.8	81.8	15.2			2165
65			510	---	---	---	---	2.32	43.4	63.7	14	6310	70.8	813
				630	---	---	---	2.87	43.5	68.3	14			1005
					930	---	---	4.24	43.5	75.7	14			1485
						1050	---	4.79	43.6	77.8	14			1677
							1230	5.62	43.6	80.3	14			1965

Nota (\*) - VENTILAZIONE SOLO L.O. / FAN ONLY SIDE COMMUTATOR

Nota (°) - Regolazione di campo / Field weakening



Potenza eccitazione Excitation power	(w)	430	Tipo Size Ventilazione Ventilation	MGL 100 L IC 06
Cost. tempo eccitaz. Field time constant	(ms)	180		
Massa del motore Mass of the motor	(Kg)	82		
Momento d'inerzia rotore Rotor inertia moment	(Kgm2)	0.028		

Avv.	Velocità nominale n/min a tensione nominale di armatura Rated speed (rev/min) at rated voltage							Potenza Power kW	Coppia vel.nomin. Torque at rated speed Nm	Rendimento Efficiency %	Circuito di armatura Armature circuit			Max giri Max. speed (°)
	170	220	260	300	400	440	500				Corrente Current Amp	Res. 115°C mOhm	Ind. mH	
66				580	---	---	---	2.69 860 ---	44.3 ---	67.9 75.4 77.5 80.0	13.2 13.2 13.2 13.2	6800	82.4	930 1376 1555 1823
67				520	---	---	---	2.37 780 ---	43.5 ---	64.8 73.0 75.3 78.0	12.2 12.2 12.2 12.2	8160	93.4	829 1247 1414 1665
68				480	---	---	---	2.26 725 ---	45.0 ---	63.8 72.5 74.7 77.6	11.8 11.8 11.8 11.8	8660	106	768 1161 1318 1554
69					660	---	---	3.03 755 ---	43.8 ---	70.1 72.6 75.6	10.8 10.8 10.8	10400	119	1059 1207 1429
70					585	---	---	2.63 670 ---	42.9 ---	67.1 69.8 73.3	9.8 9.8 9.8	12700	141	934 1070 1275
71					500	---	---	2.40 580 ---	45.8 ---	63.8 67.0 70.6	9.4 9.4 9.4	14700	172	802 926 1111
72						535	---	2.50 640 3.00	44.6 ---	66.1 69.8	8.6 8.6	16400	199	854 1026

Nota (\*) - VENTILAZIONE SOLO L.O. / FAN ONLY SIDE COMMUTATOR

Nota (°) - Regolazione di campo / Field weakening



Potenza eccitazione Excitation power	(w)	430	Tipo Size Ventilazione Ventilation	MGL 100 L IC 06
Cost. tempo eccitaz. Field time constant	(ms)	180		
Massa del motore Mass of the motor	(Kg)	82		
Momento d'inerzia rotore Rotor inertia moment	(Kgm2)	0.028		

Avv.	Velocità nominale n/min a tensione nominale di armatura Rated speed (rev/min) at rated voltage							Potenza Power	Coppia vel.nomin. Torque at rated speed Nm	Rendimento Efficiency	Circuito di armatura Armature circuit			Max giri Max. speed (°)
	170	220	260	300	400	440	500	kW	%	Corrente Current Amp	Res. 115°C mOhm	Ind. mH		
73						490	---	2.31 2.78	45.0 45.0	64.8 68.6	8.1 8.1	18200	228	784 946
74							540	2.46	43.5	66.5	7.4	21400	255	862

Nota (\*) - VENTILAZIONE SOLO L.O. / FAN ONLY SIDE COMMUTATOR

Nota (°) - Regolazione di campo / Field weakening



**MOTORI C.C. SERIE MGL**  
**GLEICHSTROMMOTOREN SERIE MGL**  
**D.C. MOTORS SERIES MGL**

Forma costr. IM B3/B5 e derivate - Mounting IM B3/B5 and derived

Protezione IP23S - Protection IP23S

Ventilazione IC06 - Cooling IC06

IN H 03

Foglio/Seite/Sheet  
D 09 93

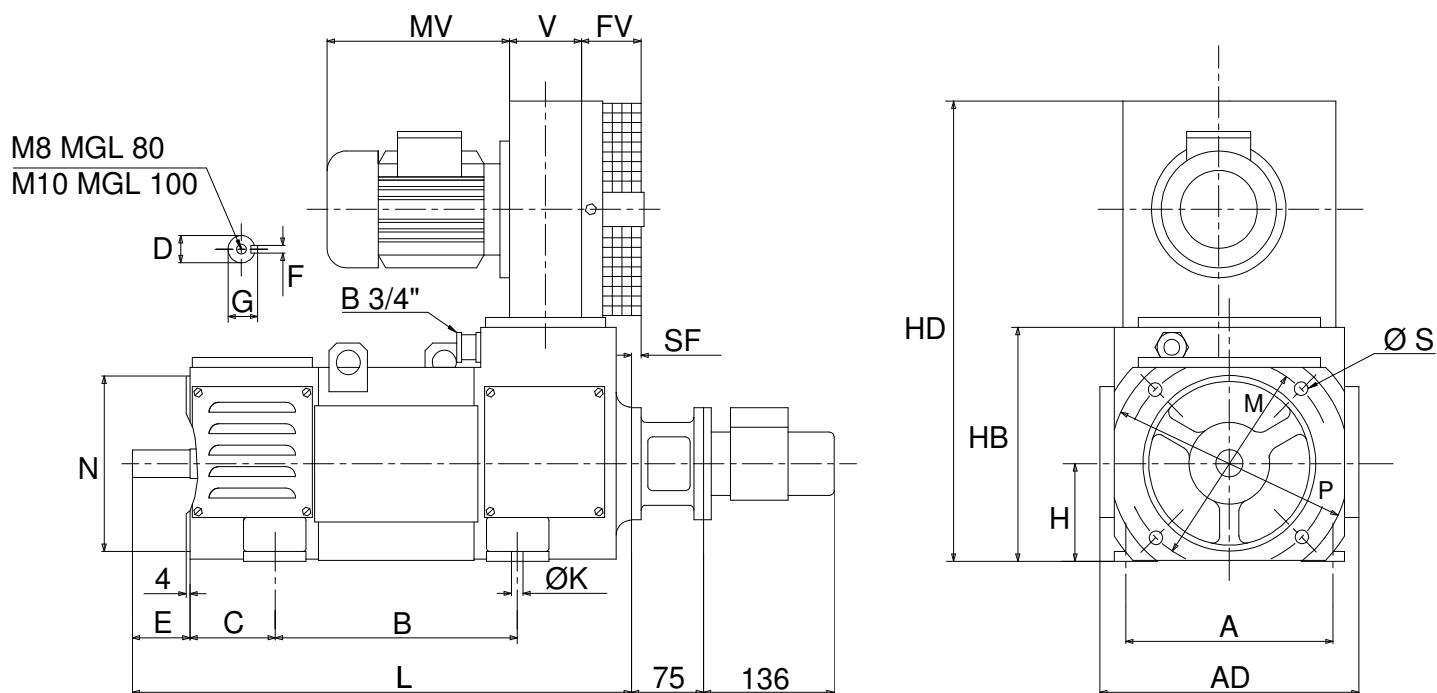

MORSETTIERA INTERNA AL COPERCHIO LATO OPPOSTO

TERMINAL BOARD INTERNAL TO CAP COLLECTOR SIDE

TIPO	PIAZZAMENTO					ALBERO				FLANGIA				INGOMBRO				ELETTOVENT.				
	A	B	C	H	K	E	D	F	G	M	N	S	P	HD	HB	L	AD	FV	MV	V	SF	
80	S	160														405						
	M	170	185	82	80	9	50	24	8	27	165	130	11,5	200	385	196	430	215	60	150	100	24
	L		220														465					
100	S		192														460					
	M	216	217	89	100	12	60	28	8	31	215	180	14	250	465	240	485	260	65	185	92	12
	L		252														520					



Potenza eccitazione Excitation power	(w)	500	Tipo Size MGL 112 S Ventilazione Ventilation IC 06
Cost. tempo eccitaz. Field time constant	(ms)	130	
Massa del motore Mass of the motor	(Kg)	82.0	
Momento d'inerzia rotore Rotor inertia moment	(Kgm2)	0.039	

Avv.	Velocità nominale n/min a tensione nominale di armatura Rated speed (rev/min) at rated voltage							Potenza Power kW	Coppia vel.nomin. Torque at rated speed Nm	Rendimento Efficiency %	Circuito di armatura Armature circuit			Max giri Max. speed (°)	
	220	260	400	440	460	470	500				Corrente Current Amp	Res. 115°C mOhm	Ind. mH		
46	3445	---	---	---	---	---	---	13.3	36.9	88.9	68.0	126	1.16	4600	*
		4105	---	---	---	---	---	15.8	36.8	89.4	68.0			4600	
47	2745	---	---	---	---	---	---	13.0	45.2	86.9	68.0	231	1.96	4390	
		3285	---	---	---	---	---	15.6	45.3	88.2	68.0			4600	
48	2225	---	---	---	---	---	---	12.8	54.9	85.6	68.0	313	2.83	3558	*
		2675	---	---	---	---	---	15.4	55.0	87.1	68.0			4282	
		4260	---	---	---	---	---	24.4	54.7	89.7	68.0			4600	
49	1865	---	---	---	---	---	---	10.9	55.8	84.0	59.0	429	3.83	2987	
		2255	---	---	---	---	---	13.2	55.9	86.0	59.0			3608	
		3610	---	---	---	---	---	21.1	55.8	89.4	59.0			4600	
		4000	---	---	---	---	---	23.4	55.9	90.1	59.0			4600	
		4195	---	---	---	---	---	24.5	55.8	90.3	59.0			4600	
		4290	---	---	---	---	---	25.1	55.9	90.5	59.0			4600	
50	1605	---	---	---	---	---	---	9.48	56.4	82.9	52.0	553	5.03	2567	
		1945	---	---	---	---	---	11.5	56.5	85.1	52.0			3110	
		3130	---	---	---	---	---	18.5	56.4	88.9	52.0			4301	
		3470	---	---	---	---	---	20.5	56.4	89.6	52.0			4354	
		3640	---	---	---	---	---	21.5	56.4	89.9	52.0			4377	
		3725	---	---	---	---	---	22.0	56.4	90.0	52.0			4388	
		3980	---	---	---	---	---	23.5	56.4	90.4	52.0			4418	
		---	---	---	---	---	---	---	---	---	---			---	
51	1405	---	---	---	---	---	---	8.28	56.3	81.8	46.0	691	6.35	2245	
		1705	---	---	---	---	---	10.1	56.6	84.4	46.0			2728	
		2760	---	---	---	---	---	16.3	56.4	88.6	46.0			3835	
		3060	---	---	---	---	---	18.1	56.5	89.4	46.0			3884	
		3215	---	---	---	---	---	18.9	56.1	89.3	46.0			3905	
		3290	---	---	---	---	---	19.4	56.3	89.7	46.0			3915	
		3515	---	---	---	---	---	20.7	56.2	90.0	46.0			3942	
		---	---	---	---	---	---	---	---	---	---			---	
52	1235	---	---	---	---	---	---	7.40	57.2	80.1	42.0	857	7.82	1975	
		1505	---	---	---	---	---	9.03	57.3	82.7	42.0			2409	
		2455	---	---	---	---	---	14.7	57.2	87.5	42.0			3404	
		2725	---	---	---	---	---	16.4	57.5	88.7	42.0			3447	
		2865	---	---	---	---	---	17.2	57.3	89.0	42.0			3466	
		2930	---	---	---	---	---	17.6	57.4	89.2	42.0			3475	
		3135	---	---	---	---	---	18.8	57.3	89.5	42.0			3499	
		---	---	---	---	---	---	---	---	---	---			---	

Nota (\*) - VENTILAZIONE SOLO L.O. / FAN ONLY SIDE COMMUTATOR

Nota (°) - Regolazione di campo / Field weakening



Potenza eccitazione Excitation power	(w)	500	Tipo Size MGL 112 S Ventilazione Ventilation IC 06
Cost. tempo eccitaz. Field time constant	(ms)	130	
Massa del motore Mass of the motor	(Kg)	82.0	
Momento d'inerzia rotore Rotor inertia moment	(Kgm2)	0.039	

Avv.	Velocità nominale n/min a tensione nominale di armatura Rated speed (rev/min) at rated voltage							Potenza Power kW	Coppia vel.nomin. Torque at rated speed Nm	Rendimento Efficiency %	Circuito di armatura Armature circuit			Max giri Max. speed (°)
	220	260	400	440	460	470	500				Corrente Current Amp	Res. 115°C mOhm	Ind. mH	
53	1100	---	---	---	---	---	---	6.57	57.0	78.6	38.0	1040	9.53	1759
		1345	---	---	---	---	---	8.05	57.2	81.5	38.0			2154
		---	2210	---	---	---	---	13.2	57.0	86.8	38.0			3103
		---	---	2455	---	---	---	14.7	57.2	87.9	38.0			3143
		---	---	---	2580	---	---	15.4	57.0	88.1	38.0			3161
		---	---	---	---	2640	---	15.8	57.2	88.5	38.0			3169
		---	---	---	---	---	2825	16.9	57.1	88.9	38.0			3192
		---	---	---	---	---	---	---	---	---	---			---
54	960	---	---	---	---	---	---	5.60	55.7	74.9	34.0	1420	11.2	1535
		1185	---	---	---	---	---	6.92	55.8	78.3	34.0			1897
		---	1975	---	---	---	---	11.5	55.6	84.6	34.0			2896
		---	---	2205	---	---	---	12.9	55.9	86.2	34.0			2936
		---	---	---	2315	---	---	13.5	55.7	86.3	34.0			2953
		---	---	---	---	2375	---	13.8	55.5	86.4	34.0			2962
		---	---	---	---	---	2545	14.8	55.5	87.1	34.0			2984
		---	---	---	---	---	---	---	---	---	---			---
55	895	---	---	---	---	---	---	5.33	56.9	75.7	32.0	1460	13.3	1430
		1105	---	---	---	---	---	6.57	56.8	79.0	32.0			1764
		---	1835	---	---	---	---	10.9	56.7	85.2	32.0			2630
		---	---	2040	---	---	---	12.2	57.1	86.6	32.0			2666
		---	---	---	2145	---	---	12.8	57.0	87.0	32.0			2681
		---	---	---	---	2200	---	13.1	56.9	87.1	32.0			2688
		---	---	---	---	---	2355	14.0	56.8	87.5	32.0			2708
		---	---	---	---	---	---	---	---	---	---			---
56	810	---	---	---	---	---	---	4.80	56.6	74.0	29.5	1720	15.3	1297
		1005	---	---	---	---	---	5.95	56.5	77.6	29.5			1608
		---	1685	---	---	---	---	9.97	56.5	84.5	29.5			2454
		---	---	1875	---	---	---	11.1	56.5	85.5	29.5			2488
		---	---	---	1975	---	---	11.7	56.6	86.2	29.5			2503
		---	---	---	---	2025	---	12.0	56.6	86.5	29.5			2510
		---	---	---	---	---	2170	12.8	56.3	86.8	29.5			2529
		---	---	---	---	---	---	---	---	---	---			---
57	735	---	---	---	---	---	---	4.35	56.5	71.9	27.5	2020	17.5	1176
		915	---	---	---	---	---	5.42	56.6	75.8	27.5			1465
		---	1550	---	---	---	---	9.17	56.5	83.4	27.5			2288
		---	---	1730	---	---	---	10.2	56.3	84.3	27.5			2321
		---	---	---	1820	---	---	10.8	56.7	85.4	27.5			2335
		---	---	---	---	1865	---	11.0	56.3	85.1	27.5			2342
		---	---	---	---	---	2000	11.8	56.3	85.8	27.5			2360
		---	---	---	---	---	---	---	---	---	---			---
58	680	---	---	---	---	---	---	4.06	57.0	71.0	26.0	2210	20.1	1088
		850	---	---	---	---	---	5.07	57.0	75.0	26.0			1360
		---	1445	---	---	---	---	8.62	57.0	82.9	26.0			2128
		---	---	1615	---	---	---	9.63	56.9	84.2	26.0			2158
		---	---	---	1700	---	---	10.1	56.7	84.4	26.0			2172
		---	---	---	---	1740	---	10.4	57.1	85.1	26.0			2178
		---	---	---	---	---	1870	11.1	56.7	85.4	26.0			2195
		---	---	---	---	---	---	---	---	---	---			---
59	625	---	---	---	---	---	---	3.65	55.8	69.1	24.0	2570	22.3	997
		785	---	---	---	---	---	4.58	55.7	73.4	24.0			1253
		---	1340	---	---	---	---	7.85	55.9	81.8	24.0			2033
		---	---	1500	---	---	---	8.79	56.0	83.2	24.0			2063
		---	---	---	1580	---	---	9.26	56.0	83.9	24.0			2077
		---	---	---	---	1620	---	9.49	55.9	84.1	24.0			2083
		---	---	---	---	---	1740	10.2	56.0	85.0	24.0			2100
		---	---	---	---	---	---	---	---	---	---			---

Nota (\*) - VENTILAZIONE SOLO L.O. / FAN ONLY SIDE COMMUTATOR

Nota (°) - Regolazione di campo / Field weakening



Potenza eccitazione Excitation power (w)	500	Tipo	
Cost. tempo eccitaz. Field time constant (ms)	130	Size	MGL 112 S
Massa del motore Mass of the motor (Kg)	82.0	Ventilazione Ventilation	IC 06
Momento d'inerzia rotore Rotor inertia moment (Kgm2)	0.039		

Avv.	Velocità nominale n/min a tensione nominale di armatura Rated speed (rev/min) at rated voltage							Potenza Power kW	Coppia vel. nomin. Torque at rated speed Nm	Rendimento Efficiency %	Circuito di armatura Armature circuit			Max giri Max. speed (°)		
	220	260	400	440	460	470	500				Corrente Current Amp	Res. 115°C mOhm	Ind. mH			
60	580	---	---	---	---	---	---	3.49	57.5	67.8	23.4	2760	25.4	924		
		730	---	---	---	---	---	4.41	57.7	72.5	23.4					
		1255	---	---	---	---	---	---	7.60	57.8	81.2				23.4	
			1405	---	---	---	---	---	8.51	57.8	82.7				23.4	
			1480	---	---	---	---	---	8.97	57.9	83.3				23.4	
				1520	---	---	---	---	9.19	57.7	83.6				23.4	
			1635	---	---	---	---	---	9.88	57.7	84.4				23.4	
				---	---	---	---	---	---	---	---				---	---
61	530	---	---	---	---	---	---	3.15	56.8	66.0	21.7	3180	28.2	851		
		675	---	---	---	---	---	4.00	56.6	70.9	21.7					
		1175	---	---	---	---	---	---	6.96	56.6	80.2				21.7	
			1320	---	---	---	---	---	7.80	56.4	81.7				21.7	
			1390	---	---	---	---	---	8.22	56.5	82.3				21.7	
				1425	---	---	---	---	8.44	56.6	82.8				21.7	
			1530	---	---	---	---	---	9.07	56.6	83.6				21.7	
				---	---	---	---	---	---	---	---				---	---
62	495	---	---	---	---	---	---	2.99	57.7	64.7	21.0	3430	31.2	792		
		630	---	---	---	---	---	3.81	57.8	69.8	21.0					
		1105	---	---	---	---	---	---	6.67	57.6	79.4				21.0	
			1240	---	---	---	---	---	7.49	57.7	81.1				21.0	
			1310	---	---	---	---	---	7.90	57.6	81.8				21.0	
				1345	---	---	---	---	8.10	57.5	82.1				21.0	
			1445	---	---	---	---	---	8.72	57.6	83.0				21.0	
				---	---	---	---	---	---	---	---				---	---
63	590	---	---	---	---	---	---	3.48	56.3	68.3	19.6	3850	34.5	943		
		1040	---	---	---	---	---	6.16	56.6	78.6	19.6					
		1170	---	---	---	---	---	---	6.92	56.5	80.2				19.6	
			1235	---	---	---	---	---	7.30	56.4	81.0				19.6	
			1270	---	---	---	---	---	7.49	56.3	81.3				19.6	
				1365	---	---	---	---	8.07	56.5	82.3				19.6	
			---	---	---	---	---	---	---	---	---				---	---
			---	---	---	---	---	---	---	---	---				---	---
64	560	---	---	---	---	---	---	3.34	57.0	68.0	18.9	4060	38.1	894		
		990	---	---	---	---	---	5.92	57.1	78.3	18.9					
		1115	---	---	---	---	---	---	6.65	57.0	80.0				18.9	
			1175	---	---	---	---	---	7.02	57.1	80.7				18.9	
			1205	---	---	---	---	---	7.21	57.1	81.2				18.9	
				1300	---	---	---	---	7.76	57.0	82.1				18.9	
			---	---	---	---	---	---	---	---	---				---	---
			---	---	---	---	---	---	---	---	---				---	---
65	520	---	---	---	---	---	---	3.14	57.7	66.4	18.2	4460	40.9	834		
		935	---	---	---	---	---	5.62	57.4	77.2	18.2					
		1050	---	---	---	---	---	---	6.33	57.6	79.0				18.2	
			1110	---	---	---	---	---	6.68	57.5	79.8				18.2	
			1140	---	---	---	---	---	6.86	57.5	80.2				18.2	
				1230	---	---	---	---	7.39	57.4	81.2				18.2	
			---	---	---	---	---	---	---	---	---				---	---
			---	---	---	---	---	---	---	---	---				---	---
66	490	---	---	---	---	---	---	2.92	56.9	64.9	17.3	4900	44.9	783		
		885	---	---	---	---	---	5.28	57.0	76.3	17.3					
		1000	---	---	---	---	---	---	5.96	56.9	78.3				17.3	
			1055	---	---	---	---	---	6.29	56.9	79.0				17.3	
			1085	---	---	---	---	---	6.46	56.9	79.4				17.3	
				1170	---	---	---	---	6.97	56.9	80.6				17.3	
			---	---	---	---	---	---	---	---	---				---	---
			---	---	---	---	---	---	---	---	---				---	---

Nota (\*) - VENTILAZIONE SOLO L.O. / FAN ONLY SIDE COMMUTATOR

Nota (°) - Regolazione di campo / Field weakening





Potenza eccitazione Excitation power (w) 500	
Cost. tempo eccitaz. Field time constant (ms) 130	
Massa del motore Mass of the motor (Kg) 82.0	
Momento d'inerzia rotore Rotor inertia moment (Kgm2) 0.039	
Tipo Size MGL 112 S	
Ventilazione Ventilation IC 06	

Avv.	Velocità nominale n/min a tensione nominale di armatura Rated speed (rev/min) at rated voltage							Potenza Power kW	Coppia vel.nomin. Torque at rated speed Nm	Rendimento Efficiency %	Circuito di armatura Armature circuit			Max giri Max. speed (°)
	220	260	400	440	460	470	500				Corrente Current Amp	Res. 115°C mOhm	Ind. mH	
67			830	---	---	---	---	5.11	58.8	74.7	17.1	5370	49.0	1311
				940	---	---	---	5.77	58.6	76.7	17.1			1333
					995	---	---	6.11	58.6	77.7	17.1			1342
						1020	---	6.27	58.7	78.0	17.1			1347
							1100	6.77	58.8	79.2	17.1			1359
68			755	---	---	---	---	4.55	57.5	73.4	15.5	6240	57.1	1211
				860	---	---	---	5.16	57.3	75.7	15.5			1255
					910	---	---	5.46	57.3	76.6	15.5			1264
						935	---	5.61	57.3	77.0	15.5			1269
							1010	6.07	57.4	78.3	15.5			1280
69			690	---	---	---	---	4.01	55.5	71.6	14.0	7410	65.1	1102
				780	---	---	---	4.56	55.8	74.0	14.0			1196
					830	---	---	4.83	55.6	75.0	14.0			1205
						850	---	4.97	55.8	75.5	14.0			1210
							935	5.38	54.9	76.9	14.0			1222
70			635	---	---	---	---	3.83	57.6	70.4	13.6	8010	75.3	1012
				720	---	---	---	4.37	58.0	73.0	13.6			1081
					765	---	---	4.63	57.8	74.0	13.6			1089
						785	---	4.76	57.9	74.5	13.6			1093
							850	5.16	58.0	75.9	13.6			1104
71			575	---	---	---	---	3.36	55.8	68.3	12.3	9580	85.1	922
				660	---	---	---	3.84	55.6	71.0	12.3			1045
					700	---	---	4.08	55.7	72.1	12.3			1054
						720	---	4.20	55.7	72.7	12.3			1058
							780	4.56	55.8	74.1	12.3			1069

Nota (\*) - VENTILAZIONE SOLO L.O. / FAN ONLY SIDE COMMUTATOR

Nota (°) - Regolazione di campo / Field weakening



Potenza eccitazione Excitation power	(w)	550	Tipo Size MGL 112 M Ventilazione Ventilation IC 06
Cost. tempo eccitaz. Field time constant	(ms)	140	
Massa del motore Mass of the motor	(Kg)	94.0	
Momento d'inerzia rotore Rotor inertia moment	(Kgm2)	0.047	

Avv.	Velocità nominale n/min a tensione nominale di armatura Rated speed (rev/min) at rated voltage							Potenza Power kW	Coppia vel.nomin. Torque at rated speed Nm	Rendimento Efficiency %	Circuito di armatura Armature circuit			Max giri Max. speed (°)		
	220	260	400	440	460	470	500				Corrente Current Amp	Res. 115°C mOhm	Ind. mH			
45	3795	---	---	---	---	---	---	13.2	33.2	88.2	68.0	118	0.872	4600	*	
		4520	---	---	---	---	---	15.8	33.4	89.4	68.0			4600		
46	2825	---	---	---	---	---	---	13.4	45.3	89.6	68.0	140	1.40	4521		
		3370	---	---	---	---	---	16.0	45.3	90.5	68.0			4600		
47	2240	---	---	---	---	---	---	13.0	55.4	86.9	68.0	260	2.36	3581	*	
		2685	---	---	---	---	---	15.6	55.5	88.2	68.0			4296		
		4250	---	---	---	---	---	24.7	55.5	90.8	68.0			4600		
48	1810	---	---	---	---	---	---	12.7	67.0	84.9	68.0	350	3.41	2892	*	
		2180	---	---	---	---	---	15.3	67.0	86.5	68.0			3489		
		3485	---	---	---	---	---	24.5	67.1	90.1	68.0			4600		
		3855	---	---	---	---	---	27.1	67.1	90.6	68.0			4600		
		4045	---	---	---	---	---	28.4	67.0	90.8	68.0			4600		
		4135	---	---	---	---	---	29.0	67.0	90.7	68.0			4600		
49	1515	---	---	---	---	---	---	10.8	68.1	83.2	59.0	481	4.62	2421		
		1835	---	---	---	---	---	13.1	68.2	85.4	59.0			2932		
		2950	---	---	---	---	---	21.1	68.3	89.4	59.0			4335		
		3270	---	---	---	---	---	23.4	68.3	90.1	59.0			4392		
		3430	---	---	---	---	---	24.5	68.2	90.3	59.0			4417		
		3510	---	---	---	---	---	25.1	68.3	90.5	59.0			4429		
		---	---	---	---	---	---	---	---	---	---			---		---
		---	---	---	---	---	---	---	---	---	---			---		---
50	1295	---	---	---	---	---	---	9.36	69.0	81.8	52.0	620	6.07	2075		
		1575	---	---	---	---	---	11.4	69.1	84.3	52.0			2522		
		2555	---	---	---	---	---	18.4	68.8	88.5	52.0			3764		
		2835	---	---	---	---	---	20.5	69.1	89.6	52.0			3814		
		2975	---	---	---	---	---	21.5	69.0	89.9	52.0			3837		
		3045	---	---	---	---	---	22.0	69.0	90.0	52.0			3847		
		3255	---	---	---	---	---	23.5	68.9	90.4	52.0			3876		
51	1130	---	---	---	---	---	---	8.15	68.9	80.5	46.0	774	7.65	1811		
		1380	---	---	---	---	---	9.94	68.8	83.1	46.0			2209		
		2250	---	---	---	---	---	16.2	68.8	88.0	46.0			3356		
		2500	---	---	---	---	---	18.0	68.8	88.9	46.0			3402		
		2620	---	---	---	---	---	18.9	68.9	89.3	46.0			3422		
		2685	---	---	---	---	---	19.3	68.6	89.3	46.0			3431		
		2870	---	---	---	---	---	20.7	68.9	90.0	46.0			3457		

Nota (\*) - VENTILAZIONE SOLO L.O. / FAN ONLY SIDE COMMUTATOR

Nota (°) - Regolazione di campo / Field weakening



Potenza eccitazione Excitation power	(w)	550	Tipo Size MGL 112 M Ventilazione Ventilation IC 06
Cost. tempo eccitaz. Field time constant	(ms)	140	
Massa del motore Mass of the motor	(Kg)	94.0	
Momento d'inerzia rotore Rotor inertia moment	(Kgm2)	0.047	

Avv.	Velocità nominale n/min a tensione nominale di armatura Rated speed (rev/min) at rated voltage							Potenza Power kW	Coppia vel.nomin. Torque at rated speed Nm	Rendimento Efficiency %	Circuito di armatura Armature circuit			Max giri Max. speed (°)
	220	260	400	440	460	470	500				Corrente Current Amp	Res. 115°C mOhm	Ind. mH	
52	990	---	---	---	---	---	---	7.26	70.0	78.6	42.0	960	9.42	1588
		1215	---	---	---	---	---	8.90	69.9	81.5	42.0			1945
		2000	---	---	---	---	---	14.6	69.7	86.9	42.0			2977
			2220	---	---	---	---	16.2	69.7	87.7	42.0			3019
		2335	---	---	---	---	---	17.1	69.9	88.5	42.0			3037
			2390	---	---	---	---	17.5	69.9	88.7	42.0			3045
		2555	---	---	---	---	---	18.7	69.9	89.0	42.0			3068
		53	880	---	---	---	---	---	---	6.42	69.7			76.8
1085	---			---	---	---	---	7.91	69.6	80.1	38.0	1735		
1795	---			---	---	---	---	13.1	69.7	86.2	38.0	2714		
	2000			---	---	---	---	14.6	69.7	87.3	38.0	2752		
2100	---			---	---	---	---	15.3	69.6	87.5	38.0	2769		
	2150			---	---	---	---	15.7	69.7	87.9	38.0	2777		
2305	---			---	---	---	---	16.8	69.6	88.4	38.0	2798		
54	760			---	---	---	---	---	---	5.42	68.1	72.5	34.0	1600
		950	---	---	---	---	---	6.75	67.9	76.4	34.0	1517		
		1600	---	---	---	---	---	11.4	68.0	83.8	34.0	2530		
			1785	---	---	---	---	12.7	67.9	84.9	34.0	2568		
		1880	---	---	---	---	---	13.4	68.1	85.7	34.0	2585		
			1925	---	---	---	---	13.7	68.0	85.7	34.0	2593		
		2065	---	---	---	---	---	14.7	68.0	86.5	34.0	2614		
		55	710	---	---	---	---	---	---	5.18	69.7	73.6	32.0	
885	---			---	---	---	---	6.42	69.3	77.2	32.0	1415		
1485	---			---	---	---	---	10.80	69.4	84.4	32.0	2299		
	1660			---	---	---	---	12.1	69.6	85.9	32.0	2333		
1745	---			---	---	---	---	12.7	69.5	86.3	32.0	2347		
	1785			---	---	---	---	13.0	69.5	86.4	32.0	2354		
1915	---			---	---	---	---	13.9	69.3	86.9	32.0	2373		
56	645			---	---	---	---	---	---	4.65	68.8	71.6	29.5	1920
		805	---	---	---	---	---	5.80	68.8	75.6	29.5	1285		
		1360	---	---	---	---	---	9.83	69.0	83.3	29.5	2144		
			1520	---	---	---	---	11.0	69.1	84.7	29.5	2176		
		1600	---	---	---	---	---	11.6	69.2	85.5	29.5	2191		
			1640	---	---	---	---	11.8	68.7	85.1	29.5	2197		
		1760	---	---	---	---	---	12.7	68.9	86.1	29.5	2216		
		57	580	---	---	---	---	---	---	4.18	68.8	69.1	27.5	
730	---			---	---	---	---	5.26	68.8	73.6	27.5	1167		
1250	---			---	---	---	---	9.02	68.9	82.0	27.5	1998		
	1400			---	---	---	---	10.10	68.9	83.5	27.5	2030		
1475	---			---	---	---	---	10.6	68.6	83.8	27.5	2043		
	1510			---	---	---	---	10.9	68.9	84.3	27.5	2050		
1625	---			---	---	---	---	11.7	68.8	85.1	27.5	2067		
58	535			---	---	---	---	---	---	3.90	69.6	68.2	26.0	2480
		675	---	---	---	---	---	4.92	69.6	72.8	26.0	1081		
		1165	---	---	---	---	---	8.48	69.5	81.5	26.0	1858		
			1305	---	---	---	---	9.49	69.4	83.0	26.0	1887		
		1375	---	---	---	---	---	10.0	69.4	83.6	26.0	1900		
			1410	---	---	---	---	10.2	69.1	83.5	26.0	1906		
		1515	---	---	---	---	---	11.0	69.3	84.6	26.0	1922		

Nota (\*) - VENTILAZIONE SOLO L.O. / FAN ONLY SIDE COMMUTATOR

Nota (°) - Regolazione di campo / Field weakening



Potenza eccitazione Excitation power (w) 550	Tipo
Cost. tempo eccitaz. Field time constant (ms) 140	Size MGL 112 M
Massa del motore Mass of the motor (Kg) 94.0	Ventilazione Ventilation IC 06
Momento d'inerzia rotore Rotor inertia moment (Kgm2) 0.047	

Avv.	Velocità nominale n/min a tensione nominale di armatura Rated speed (rev/min) at rated voltage							Potenza Power kW	Coppia vel. nomin. Torque at rated speed Nm	Rendimento Efficiency %	Circuito di armatura Armature circuit			Max giri Max. speed (°)						
	220	260	400	440	460	470	500				Corrente Current Amp	Res. 115°C mOhm	Ind. mH							
59	490	---	---	---	---	---	---	3.49	68.0	66.1	24.0	2880	26.9	782						
		620	---	---	---	---	---	4.43	68.2	71.0	24.0				993					
		1080	---	---	---	---	---	7.71	68.2	80.3	24.0				1729					
			1210	---	---	---	---	8.65	68.3	81.9	24.0				1803					
		1280	---	---	---	---	---	9.12	68.0	82.6	24.0				1816					
			1310	---	---	---	---	9.35	68.2	82.9	24.0				1822					
				1410	---	---	---	---	10.1	68.4	84.2				24.0	1838				
			60	450	---	---	---	---	---	---	3.33				70.7	64.7	23.4	3100	30.6	723
575	---	---			---	---	---	4.25	70.6	69.9	23.4	921								
1010	---	---			---	---	---	7.45	70.4	79.6	23.4	1617								
	1135	---			---	---	---	8.36	70.3	81.2	23.4	1655								
1195	---	---			---	---	---	8.82	70.5	81.9	23.4	1666								
	1230	---			---	---	---	9.05	70.3	82.3	23.4	1672								
		1320			---	---	---	---	9.74	70.5	83.2	23.4	1686							
	61	530			---	---	---	---	---	---	3.84	69.2	68.1	21.7	3550	34.0	851			
945			---	---	---	---	---	6.81	68.8	78.5	21.7	1510								
1060			---	---	---	---	---	7.66	69.0	80.2	21.7	1594								
			1120	---	---	---	---	8.08	68.9	80.9	21.7	1606								
1150			---	---	---	---	---	8.29	68.8	81.3	21.7	1611								
			1240	---	---	---	---	8.93	68.8	82.3	21.7	1626								
				62	495	---	---	---	---	---	---	3.64	70.2	66.7				21.0	3840	37.6
			885			---	---	---	---	---	6.52	70.4	77.6	21.0				1418		
1000	---	---	---			---	---	7.34	70.1	79.4	21.0	1507								
	1055	---	---			---	---	7.75	70.1	80.2	21.0	1519								
1080	---	---	---			---	---	7.96	70.4	80.6	21.0	1524								
	1165	---	---			---	---	8.57	70.2	81.6	21.0	1538								
		63	460			---	---	---	---	---	---	3.33	69.1	65.3	19.6	4310	41.5	738		
	835					---	---	---	---	---	6.01	68.7	76.7	19.6	1335					
940	---			---	---	---	---	6.78	68.9	78.6	19.6	1440								
	995			---	---	---	---	7.16	68.7	79.4	19.6	1451								
1020	---			---	---	---	---	7.35	68.8	79.8	19.6	1456								
	1100			---	---	---	---	7.93	68.8	80.9	19.6	1470								
				64	435	---	---	---	---	---	---	3.18	69.8	64.7	18.9				4540	46.0
	795					---	---	---	---	---	5.77	69.3	76.3	18.9	1269					
895	---	---	---			---	---	6.51	69.5	78.3	18.9	1362								
	945	---	---			---	---	6.88	69.5	79.1	18.9	1373								
970	---	---	---			---	---	7.07	69.6	79.6	18.9	1377								
	1045	---	---			---	---	7.62	69.6	80.6	18.9	1390								
		65	745			---	---	---	---	---	---	5.47	70.1	75.1	18.2	5000	49.3	1193		
	845					---	---	---	---	---	6.18	69.8	77.2	18.2	1293					
890	---			---	---	---	---	6.54	70.2	78.1	18.2	1303								
	915			---	---	---	---	6.71	70.0	78.4	18.2	1307								
990	---			---	---	---	---	7.25	69.9	79.7	18.2	1320								

Nota (\*) - VENTILAZIONE SOLO L.O. / FAN ONLY SIDE COMMUTATOR

Nota (°) - Regolazione di campo / Field weakening



Potenza eccitazione Excitation power	(w)	550	Tipo Size MGL 112 M Ventilazione Ventilation IC 06
Cost. tempo eccitaz. Field time constant	(ms)	140	
Massa del motore Mass of the motor	(Kg)	94.0	
Momento d'inerzia rotore Rotor inertia moment	(Kgm2)	0.047	

Avv.	Velocità nominale n/min a tensione nominale di armatura Rated speed (rev/min) at rated voltage							Potenza Power kW	Coppia vel.nomin. Torque at rated speed Nm	Rendimento Efficiency %	Circuito di armatura Armature circuit			Max giri Max. speed (°)
	220	260	400	440	460	470	500				Corrente Current Amp	Res. 115°C mOhm	Ind. mH	
66			705	---	---	---	---	5.13	69.5	74.1	17.3	5470	54.1	1130
			800	---	---	---	5.81	69.4	76.3	17.3	1246			
			845	---	---	---	6.15	69.5	77.3	17.3	1256			
			870	---	---	---	6.32	69.4	77.7	17.3	1260			
			940	---	---	---	6.83	69.4	79.0	17.3	1273			
67			660	---	---	---	---	4.94	71.5	72.2	17.1	6020	59.1	1055
			750	---	---	---	5.61	71.4	74.6	17.1	1162			
			795	---	---	---	5.94	71.3	75.5	17.1	1172			
			815	---	---	---	6.11	71.6	76.0	17.1	1176			
			885	---	---	---	6.61	71.3	77.3	17.1	1188			
68			600	---	---	---	---	4.40	70.0	71.0	15.5	6980	68.8	960
			685	---	---	---	5.00	69.7	73.3	15.5	1092			
			725	---	---	---	5.31	69.9	74.5	15.5	1103			
			745	---	---	---	5.46	70.0	74.9	15.5	1107			
			805	---	---	---	5.91	70.1	76.3	15.5	1119			
69			545	---	---	---	---	3.86	67.6	68.9	14.0	8280	78.4	869
			620	---	---	---	4.41	67.9	71.6	14.0	993			
			660	---	---	---	4.68	67.7	72.7	14.0	1050			
			680	---	---	---	4.82	67.7	73.3	14.0	1055			
			735	---	---	---	5.23	67.9	74.7	14.0	1067			
70			500	---	---	---	---	3.68	70.3	67.6	13.6	8960	90.8	796
			570	---	---	---	4.21	70.5	70.4	13.6	912			
			605	---	---	---	4.48	70.7	71.6	13.6	949			
			625	---	---	---	4.61	70.4	72.1	13.6	953			
			680	---	---	---	5.01	70.4	73.7	13.6	964			
71			450	---	---	---	---	3.20	67.9	65.0	12.3	10700	103	721
			520	---	---	---	3.68	67.6	68.0	12.3	829			
			550	---	---	---	3.93	68.2	69.5	12.3	884			
			570	---	---	---	4.05	67.9	70.1	12.3	911			
			620	---	---	---	4.41	67.9	71.7	12.3	932			

Nota (\*) - VENTILAZIONE SOLO L.O. / FAN ONLY SIDE COMMUTATOR

Nota (°) - Regolazione di campo / Field weakening



Potenza eccitazione Excitation power	(w)	600	Tipo Size MGL 112 L Ventilazione Ventilation IC 06
Cost. tempo eccitaz. Field time constant	(ms)	150	
Massa del motore Mass of the motor	(Kg)	110	
Momento d'inerzia rotore Rotor inertia moment	(Kgm2)	0.057	

Avv.	Velocità nominale n/min a tensione nominale di armatura Rated speed (rev/min) at rated voltage							Potenza Power kW	Coppia vel.nomin. Torque at rated speed Nm	Rendimento Efficiency %	Circuito di armatura Armature circuit			Max giri Max. speed (°)
	220	260	400	440	460	470	500				Corrente Current Amp	Res. 115°C mOhm	Ind. mH	
45	3055	---	---	---	---	---	---	13.3	41.6	88.9	68.0	136	1.07	4600 4600
		3640	---	---	---	---	---	15.9	41.7	89.9	68.0			
46	2275	---	---	---	---	---	---	13.4	56.2	89.6	68.0	160	1.71	3636 4339 4600
		2710	---	---	---	---	---	16.0	56.4	90.5	68.0			
		4250	---	---	---	---	---	25.1	56.4	92.3	68.0			
47	1790	---	---	---	---	---	---	12.9	68.8	86.2	68.0	298	2.90	2861 3444 4600 4600 4600 4600
		2150	---	---	---	---	---	15.5	68.8	87.7	68.0			
		3415	---	---	---	---	---	24.7	69.1	90.8	68.0			
		3780	---	---	---	---	---	27.3	69.0	91.2	68.0			
		3960	---	---	---	---	---	28.6	69.0	91.4	68.0			
		4050	---	---	---	---	---	29.3	69.1	91.7	68.0			
48	1440	---	---	---	---	---	---	12.6	83.6	84.2	68.0	400	4.19	2301 2783 4389 4451 4478 4491 4526
		1740	---	---	---	---	---	15.2	83.4	86.0	68.0			
		2975	---	---	---	---	---	24.4	78.3	89.7	68.0			
		3095	---	---	---	---	---	27.0	83.3	90.2	68.0			
		3250	---	---	---	---	---	28.3	83.2	90.5	68.0			
		3325	---	---	---	---	---	29.0	83.3	90.7	68.0			
		3550	---	---	---	---	---	31.0	83.4	91.2	68.0			
49	1200	---	---	---	---	---	---	10.6	84.4	81.7	59.0	549	5.67	1918 2332 3715 3768 3792 3803
		1455	---	---	---	---	---	12.9	84.7	84.1	59.0			
		2360	---	---	---	---	---	21.0	85.0	89.0	59.0			
		2620	---	---	---	---	---	23.3	84.9	89.8	59.0			
		2750	---	---	---	---	---	24.4	84.7	89.9	59.0			
		2815	---	---	---	---	---	25.0	84.8	90.2	59.0			
50	1025	---	---	---	---	---	---	9.18	85.5	80.2	52.0	708	7.44	1639 2000 3225 3272 3292 3302 3329
		1250	---	---	---	---	---	11.2	85.6	82.8	52.0			
		2040	---	---	---	---	---	18.3	85.7	88.0	52.0			
		2270	---	---	---	---	---	20.3	85.4	88.7	52.0			
		2380	---	---	---	---	---	21.3	85.5	89.0	52.0			
		2440	---	---	---	---	---	21.9	85.7	89.6	52.0			
		2610	---	---	---	---	---	23.4	85.6	90.0	52.0			
51	890	---	---	---	---	---	---	7.96	85.4	78.7	46.0	884	9.39	1425 1747 2873 2917 2936 2944 2969
		1090	---	---	---	---	---	9.76	85.5	81.6	46.0			
		1795	---	---	---	---	---	16.0	85.1	87.0	46.0			
		1995	---	---	---	---	---	17.8	85.2	87.9	46.0			
		2095	---	---	---	---	---	18.7	85.2	88.4	46.0			
		2150	---	---	---	---	---	19.2	85.3	88.8	46.0			
2300	---	---	---	---	---	20.5	85.1	89.1	46.0					

Nota (\*) - VENTILAZIONE SOLO L.O. / FAN ONLY SIDE COMMUTATOR

Nota (°) - Regolazione di campo / Field weakening



Potenza eccitazione Excitation power	(w)	600	Tipo	
Cost. tempo eccitaz. Field time constant	(ms)	150	Size	MGL 112 L
Massa del motore Mass of the motor	(Kg)	110	Ventilazione Ventilation	IC 06
Momento d'inerzia rotore Rotor inertia moment	(Kgm2)	0.057		

Avv.	Velocità nominale n/min a tensione nominale di armatura Rated speed (rev/min) at rated voltage							Potenza Power kW	Coppia vel.nomin. Torque at rated speed Nm	Rendimento Efficiency %	Circuito di armatura Armature circuit			Max giri Max. speed (°)
	220	260	400	440	460	470	500				Corrente Current Amp	Res. 115°C mOhm	Ind. mH	
52	775	---	---	---	---	---	---	7.05	86.9	76.3	42.0	1100	11.6	1244
		960	---	---	---	---	---	8.70	86.5	79.7				1533
		1590	---	---	---	---	---	14.4	86.5	85.7				2547
		1775	---	---	---	---	---	16.1	86.6	87.1				2588
		1865	---	---	---	---	---	16.9	86.5	87.5				2605
		1910	---	---	---	---	---	17.3	86.5	87.6				2613
		2045	---	---	---	---	---	18.5	86.4	88.1				2634
		---	---	---	---	---	---	---	---	---				---
53	685	---	---	---	---	---	---	6.21	86.6	74.3	38.0	1340	14.1	1100
		850	---	---	---	---	---	7.70	86.5	77.9				1363
		1430	---	---	---	---	---	12.9	86.1	84.9				2284
		1590	---	---	---	---	---	14.4	86.5	86.1				2359
		1675	---	---	---	---	---	15.1	86.1	86.4				2374
		1715	---	---	---	---	---	15.5	86.3	86.8				2382
		1840	---	---	---	---	---	16.6	86.2	87.4				2402
		---	---	---	---	---	---	---	---	---				---
54	585	---	---	---	---	---	---	5.17	84.4	69.1	34.0	1840	16.5	938
		735	---	---	---	---	---	6.51	84.6	73.6				1179
		1265	---	---	---	---	---	11.2	84.5	82.4				2024
		1415	---	---	---	---	---	12.5	84.4	83.6				2198
		1490	---	---	---	---	---	13.2	84.6	84.4				2214
		1530	---	---	---	---	---	13.5	84.3	84.5				2222
		1640	---	---	---	---	---	14.5	84.4	85.3				2242
		---	---	---	---	---	---	---	---	---				---
55	550	---	---	---	---	---	---	4.96	86.1	70.5	32.0	1860	19.6	881
		690	---	---	---	---	---	6.22	86.1	74.8				1104
		1175	---	---	---	---	---	10.60	86.1	82.8				1883
		1315	---	---	---	---	---	11.9	86.4	84.5				1998
		1385	---	---	---	---	---	12.5	86.2	84.9				2012
		1420	---	---	---	---	---	12.8	86.1	85.1				2018
		1525	---	---	---	---	---	13.7	85.8	85.6				2036
		---	---	---	---	---	---	---	---	---				---
56	495	---	---	---	---	---	---	4.43	85.5	68.3	29.5	2200	22.7	791
		625	---	---	---	---	---	5.58	85.3	72.8				998
		1075	---	---	---	---	---	9.63	85.5	81.6				1722
		1205	---	---	---	---	---	10.8	85.6	83.2				1863
		1270	---	---	---	---	---	11.4	85.7	84.0				1876
		1305	---	---	---	---	---	11.7	85.6	84.4				1883
		1400	---	---	---	---	---	12.5	85.3	84.7				1900
		---	---	---	---	---	---	---	---	---				---
57	445	---	---	---	---	---	---	3.96	85.0	65.5	27.5	2590	25.9	708
		565	---	---	---	---	---	5.04	85.2	70.5				901
		985	---	---	---	---	---	8.81	85.4	80.1				1577
		1105	---	---	---	---	---	9.89	85.5	81.7				1736
		1165	---	---	---	---	---	10.4	85.2	82.2				1749
		1195	---	---	---	---	---	10.7	85.5	82.8				1755
		1285	---	---	---	---	---	11.5	85.5	83.6				1772
		---	---	---	---	---	---	---	---	---				---
58	410	---	---	---	---	---	---	3.68	85.7	64.3	26.0	2830	29.8	653
		520	---	---	---	---	---	4.70	86.3	69.5				834
		915	---	---	---	---	---	8.27	86.3	79.5				1467
		1030	---	---	---	---	---	9.29	86.1	81.2				1615
		1085	---	---	---	---	---	9.80	86.3	81.9				1627
		1115	---	---	---	---	---	10.1	86.5	82.7				1632
		1200	---	---	---	---	---	10.8	85.9	83.1				1648
		---	---	---	---	---	---	---	---	---				---

Nota (\*) - VENTILAZIONE SOLO L.O. / FAN ONLY SIDE COMMUTATOR

Nota (°) - Regolazione di campo / Field weakening





Potenza eccitazione Excitation power (w)	600	Tipo		
Cost. tempo eccitaz. Field time constant (ms)	150	Size	MGL	112 L
Massa del motore Mass of the motor (Kg)	110	Ventilazione Ventilation	IC 06	
Momento d'inerzia rotore Rotor inertia moment (Kgm2)	0.057			

Avv.	Velocità nominale n/min a tensione nominale di armatura Rated speed (rev/min) at rated voltage							Potenza Power kW	Coppia vel. nomin. Torque at rated speed Nm	Rendimento Efficiency %	Circuito di armatura Armature circuit			Max giri Max. speed (°)
	220	260	400	440	460	470	500				Corrente Current Amp	Res. 115°C mOhm	Ind. mH	
59		475	---	---	---	---	---	4.21	84.6	67.5	24.0	3290	33.0	761 1358 1528 1554 1559 1575
			850	---	---	---	---	7.50	84.3	78.1	24.0			
				955	---	---	---	8.45	84.5	80.0	24.0			
					1010	---	---	8.92	84.3	80.8	24.0			
						1035	---	9.15	84.4	81.1	24.0			
							1115	9.86	84.4	82.2	24.0			
60		440	---	---	---	---	---	4.02	87.2	66.1	23.4	3540	37.6	704 1267 1415 1426 1431 1445
			790	---	---	---	---	7.24	87.5	77.4	23.4			
				895	---	---	---	8.16	87.1	79.3	23.4			
					945	---	---	8.61	87.0	80.0	23.4			
						970	---	8.84	87.0	80.4	23.4			
							1045	9.53	87.1	81.5	23.4			
61		405	---	---	---	---	---	3.62	85.4	64.2	21.7	4060	41.7	647 1181 1333 1373 1378 1392
			740	---	---	---	---	6.60	85.2	76.0	21.7			
				835	---	---	---	7.45	85.2	78.0	21.7			
					880	---	---	7.88	85.5	78.9	21.7			
						905	---	8.09	85.4	79.3	21.7			
							975	8.73	85.5	80.5	21.7			
62			690	---	---	---	---	6.30	87.2	75.0	21.0	4390	46.2	1107 1251 1299 1304 1318
				780	---	---	---	7.13	87.3	77.2	21.0			
					825	---	---	7.54	87.3	78.1	21.0			
						850	---	7.74	87.0	78.4	21.0			
							920	8.36	86.8	79.6	21.0			
63			650	---	---	---	---	5.80	85.2	74.0	19.6	4920	51.0	1039 1177 1240 1245 1258
				735	---	---	---	6.57	85.4	76.2	19.6			
					780	---	---	6.95	85.1	77.1	19.6			
						800	---	7.15	85.3	77.6	19.6			
							865	7.72	85.2	78.8	19.6			
64			615	---	---	---	---	5.57	86.5	73.7	18.9	5170	56.4	988 1119 1173 1177 1190
				700	---	---	---	6.31	86.1	75.9	18.9			
					740	---	---	6.68	86.2	76.8	18.9			
						760	---	6.87	86.3	77.3	18.9			
							825	7.42	85.9	78.5	18.9			
65			580	---	---	---	---	5.25	86.4	72.1	18.2	5700	60.5	926 1051 1113 1117 1129
				655	---	---	---	5.97	87.0	74.6	18.2			
					695	---	---	6.33	87.0	75.6	18.2			
						715	---	6.51	86.9	76.1	18.2			
							775	7.04	86.7	77.4	18.2			

Nota (\*) - VENTILAZIONE SOLO L.O. / FAN ONLY SIDE COMMUTATOR

Nota (°) - Regolazione di campo / Field weakening





Potenza eccitazione Excitation power	(w)	600	Tipo Size Ventilazione Ventilation	MGL 112 L IC 06
Cost. tempo eccitaz. Field time constant	(ms)	150		
Massa del motore Mass of the motor	(Kg)	110		
Momento d'inerzia rotore Rotor inertia moment	(Kgm2)	0.057		

Avv.	Velocità nominale n/min a tensione nominale di armatura Rated speed (rev/min) at rated voltage							Potenza Power kW	Coppia vel.nomin. Torque at rated speed Nm	Rendimento Efficiency %	Circuito di armatura Armature circuit			Max giri Max. speed (°)
	220	260	400	440	460	470	500				Corrente Current Amp	Res. 115°C mOhm	Ind. mH	
66			545	---	---	---	---	4.92	86.2	71.1	17.3	6240	66.4	875
				620	---	---	---	5.60	86.3	73.6	17.3			995
					660	---	---	5.94	85.9	74.6	17.3			1055
						680	---	6.11	85.8	75.1	17.3			1076
						735	---	6.62	86.0	76.5	17.3			1088
67			505	---	---	---	---	4.71	89.1	68.9	17.1	6880	72.5	811
				580	---	---	---	5.38	88.6	71.5	17.1			927
					615	---	---	5.71	88.7	72.6	17.1			985
						635	---	5.88	88.4	73.2	17.1			1004
						690	---	6.39	88.4	74.7	17.1			1015
68			460	---	---	---	---	4.18	86.8	67.4	15.5	7960	84.4	736
				525	---	---	---	4.79	87.1	70.2	15.5			843
					560	---	---	5.09	86.8	71.4	15.5			897
						575	---	5.24	87.0	71.9	15.5			924
						630	---	5.70	86.4	73.5	15.5			956
69			415	---	---	---	---	3.65	84.0	65.2	14.0	9450	96.2	663
				475	---	---	---	4.20	84.4	68.2	14.0			763
					510	---	---	4.47	83.7	69.4	14.0			813
						525	---	4.61	83.9	70.1	14.0			838
						570	---	5.02	84.1	71.7	14.0			910
70				435	---	---	---	3.99	87.6	66.7	13.6	10200	111	698
					465	---	---	4.26	87.5	68.1	13.6			745
						480	---	4.39	87.3	68.7	13.6			768
						525	---	4.79	87.1	70.4	13.6			822
71				395	---	---	---	3.47	83.9	64.1	12.3	12200	126	631
					420	---	---	3.71	84.4	65.6	12.3			674
						435	---	3.83	84.1	66.3	12.3			696
						475	---	4.20	84.4	68.3	12.3			762

Nota (\*) - VENTILAZIONE SOLO L.O. / FAN ONLY SIDE COMMUTATOR

Nota (°) - Regolazione di campo / Field weakening



Potenza eccitazione Excitation power	(w)	650	Tipo Size MGL 132 S Ventilazione Ventilation IC 06
Cost. tempo eccitaz. Field time constant	(ms)	160	
Massa del motore Mass of the motor	(Kg)	139	
Momento d'inerzia rotore Rotor inertia moment	(Kgm2)	0.095	

Avv.	Velocità nominale n/min a tensione nominale di armatura Rated speed (rev/min) at rated voltage							Potenza Power kW	Coppia vel.nomin. Torque at rated speed Nm	Rendimento Efficiency %	Circuito di armatura Armature circuit			Max giri Max. speed (°)	
	220	260	400	440	460	470	520				Corrente Current Amp	Res. 115°C mOhm	Ind. mH		
45	3035	---	---	---	---	---	---	27.0	85.0	89.6	137	75.7	0.807	4500	*
		3620	---	---	---	---	---	32.2	84.9	90.4	137				
46	2135	---	---	---	---	---	---	25.3	113.2	87.8	131	131	1.53	3419	*
		2565	---	---	---	---	---	30.4	113.2	89.3	131				
		4055	---	---	---	---	---	48.0	113.0	91.6	131				
			4480	---	---	---	---	53.1	113.2	92.1	131				
47	1730	---	---	---	---	---	---	20.0	110.4	86.6	105	199	2.28	2765	
		2080	---	---	---	---	---	24.1	110.6	88.3	105				
		3305	---	---	---	---	---	38.2	110.4	91.0	105				
			3660	---	---	---	---	42.3	110.4	91.6	105				
		3835	---	---	---	---	---	44.4	110.6	91.9	105				
			3920	---	---	---	---	45.4	110.6	92.0	105				
48	1400	---	---	---	---	---	---	16.3	111.2	84.2	88.0	302	3.26	2238	
		1690	---	---	---	---	---	19.7	111.3	86.1	88.0				
		2715	---	---	---	---	---	31.7	111.5	90.1	88.0				
			3005	---	---	---	---	35.1	111.5	90.7	88.0				
		3155	---	---	---	---	---	36.8	111.4	90.9	88.0				
			3225	---	---	---	---	37.7	111.6	91.2	88.0				
		3590	---	---	---	---	41.9	111.5	91.6	88.0					
		49	1175	---	---	---	---	---	---	14.2	115.4				
1430	---			---	---	---	---	17.3	115.5	85.3	78.0				
2305	---			---	---	---	---	27.9	115.6	89.4	78.0				
	2555			---	---	---	---	30.9	115.5	90.0	78.0				
2680	---			---	---	---	---	32.4	115.4	90.3	78.0				
	2745			---	---	---	---	33.2	115.5	90.6	78.0				
50	1005			---	---	---	---	---	---	12.3	116.9	81.0	69.0	505	5.86
		1225	---	---	---	---	---	15.0	116.9	83.6	69.0				
		1990	---	---	---	---	---	24.4	117.1	88.4	69.0				
			2210	---	---	---	---	27.1	117.1	89.3	69.0				
		2320	---	---	---	---	---	28.4	116.9	89.5	69.0				
			2375	---	---	---	---	29.1	117.0	89.7	69.0				
		2650	---	---	---	---	32.5	117.1	90.6	69.0					
		51	875	---	---	---	---	---	---	10.7	116.8	79.7	61.0		
1070	---			---	---	---	---	13.0	116.0	82.0	61.0				
1750	---			---	---	---	---	21.4	116.8	87.7	61.0				
	1945			---	---	---	---	23.9	117.3	89.0	61.0				
2045	---			---	---	---	---	24.9	116.3	88.7	61.0				
	2090			---	---	---	---	25.5	116.5	88.9	61.0				
2335	---			---	---	---	28.5	116.6	89.8	61.0					

Nota (\*) - VENTILAZIONE SOLO L.O. / FAN ONLY SIDE COMMUTATOR

Nota (°) - Regolazione di campo / Field weakening



Potenza eccitazione Excitation power	(w)	650	Tipo		
Cost. tempo eccitaz. Field time constant	(ms)	160	Size	MGL	132 S
Massa del motore Mass of the motor	(Kg)	139	Ventilazione Ventilation		IC 06
Momento d'inerzia rotore Rotor inertia moment	(Kgm2)	0.095			

Avv.	Velocità nominale n/min a tensione nominale di armatura Rated speed (rev/min) at rated voltage							Potenza Power kW	Coppia vel.nomin. Torque at rated speed Nm	Rendimento Efficiency %	Circuito di armatura Armature circuit			Max giri Max. speed (°)
	220	260	400	440	460	470	520				Corrente Current Amp	Res. 115°C mOhm	Ind. mH	
52	765	---	---	---	---	---	---	9.37	117.0	77.4	55.0	788	9.15	1225
		940	---	---	---	---	---	11.5	116.8	80.4	55.0			1506
		---	1555	---	---	---	---	19.0	116.7	86.4	55.0			2177
		---	---	1730	---	---	---	21.2	117.0	87.6	55.0			2205
		---	---	---	1820	---	---	22.3	117.0	88.1	55.0			2217
		---	---	---	---	1860	---	22.8	117.1	88.2	55.0			2223
		---	---	---	---	---	---	---	---	---	---			---
53	680	---	---	---	---	---	---	8.31	116.7	75.5	50.0	954	11.1	1086
		840	---	---	---	---	---	10.3	117.1	79.2	50.0			1341
		---	1395	---	---	---	---	17.1	117.1	85.5	50.0			1976
		---	---	1555	---	---	---	19.0	116.7	86.4	50.0			2002
		---	---	---	1635	---	---	20.0	116.8	87.0	50.0			2013
		---	---	---	---	1675	---	20.5	116.9	87.2	50.0			2019
		---	---	---	---	---	1875	23.0	117.1	88.5	50.0			2043
54	605	---	---	---	---	---	---	7.29	115.1	73.6	45.0	1150	13.1	971
		755	---	---	---	---	---	9.05	114.5	77.4	45.0			1205
		---	1265	---	---	---	---	15.2	114.7	84.4	45.0			1837
		---	---	1410	---	---	---	17.0	115.1	85.9	45.0			1863
		---	---	---	1485	---	---	17.8	114.5	86.0	45.0			1874
		---	---	---	---	1520	---	18.3	115.0	86.5	45.0			1879
		---	---	---	---	---	1705	20.5	114.8	87.6	45.0			1902
55	540	---	---	---	---	---	---	6.41	113.4	71.1	41.0	1410	15.3	864
		675	---	---	---	---	---	8.01	113.3	75.1	41.0			1080
		---	1150	---	---	---	---	13.6	112.9	82.9	41.0			1711
		---	---	1285	---	---	---	15.2	113.0	84.3	41.0			1736
		---	---	---	1350	---	---	16.0	113.2	84.8	41.0			1747
		---	---	---	---	1385	---	16.4	113.1	85.1	41.0			1752
		---	---	---	---	---	1550	18.4	113.4	86.3	41.0			1774
56	490	---	---	---	---	---	---	6.07	118.3	69.9	39.5	1540	17.8	787
		615	---	---	---	---	---	7.61	118.2	74.1	39.5			988
		---	1055	---	---	---	---	13.0	117.7	82.3	39.5			1581
		---	---	1180	---	---	---	14.6	118.2	84.0	39.5			1604
		---	---	---	1245	---	---	15.3	117.4	84.2	39.5			1614
		---	---	---	---	1275	---	15.7	117.6	84.6	39.5			1619
		---	---	---	---	---	1430	17.6	117.5	85.7	39.5			1640
57	450	---	---	---	---	---	---	5.59	118.6	68.7	37.0	1710	20.4	723
		570	---	---	---	---	---	7.04	117.9	73.2	37.0			910
		---	980	---	---	---	---	12.1	117.9	81.8	37.0			1429
		---	---	1095	---	---	---	13.5	117.7	82.9	37.0			1449
		---	---	---	1155	---	---	14.3	118.2	84.0	37.0			1458
		---	---	---	---	1185	---	14.6	117.7	84.0	37.0			1462
		---	---	---	---	---	1330	16.4	117.8	85.2	37.0			1481
58	410	---	---	---	---	---	---	4.98	116.0	66.6	34.0	2000	23.2	658
		520	---	---	---	---	---	6.31	115.9	71.4	34.0			833
		---	905	---	---	---	---	11.0	116.1	80.9	34.0			1360
		---	---	1015	---	---	---	12.3	115.7	82.2	34.0			1381
		---	---	---	1070	---	---	13.0	116.0	83.1	34.0			1390
		---	---	---	---	1095	---	13.3	116.0	83.2	34.0			1394
		---	---	---	---	---	1235	14.9	115.2	84.3	34.0			1412

Nota (\*) - VENTILAZIONE SOLO L.O. / FAN ONLY SIDE COMMUTATOR

Nota (°) - Regolazione di campo / Field weakening



Potenza eccitazione Excitation power (w)	650	Tipo Size MGL 132 S Ventilazione Ventilation IC 06
Cost. tempo eccitaz. Field time constant (ms)	160	
Massa del motore Mass of the motor (Kg)	139	
Momento d'inerzia rotore Rotor inertia moment (Kgm2)	0.095	

Avv.	Velocità nominale n/min a tensione nominale di armatura Rated speed (rev/min) at rated voltage							Potenza Power kW	Coppia vel. nomin. Torque at rated speed Nm	Rendimento Efficiency %	Circuito di armatura Armature circuit			Max giri Max. speed (°)	
	220	260	400	440	460	470	520				Corrente Current Amp	Res. 115°C mOhm	Ind. mH		
59	370	---	---	---	---	---	---	4.51	116.4	64.1	32.0	2300	26.0	595	
		475	---	---	---	---	---	5.76	115.8	69.2	32.0				760
		835	---	---	---	---	---	10.1	115.5	78.9	32.0				1277
			940	---	---	---	---	11.4	115.8	81.0	32.0				1297
		990	---	---	---	---	---	12.0	115.7	81.5	32.0				1306
			1015	---	---	---	---	12.3	115.7	81.8	32.0				1310
		1145		---	---	---	---	13.9	115.9	83.5	32.0				1327
60	445	---	---	---	---	---	---	5.34	114.6	68.5	2530	29.5	710		
		785	---	---	---	---	---	9.44	114.8	78.7				1213	
		880	---	---	---	---	---	10.6	115.0	80.3				30.0	1232
			930	---	---	---	---	11.2	115.0	81.2				30.0	1240
		955	---	---	---	---	---	11.5	115.0	81.6				30.0	1244
			1075	---	---	---	---	13.0	115.5	83.3				30.0	1261
		61		410	---	---	---	---	---	---				4.96	115.5
735	---		---		---	---	---	8.86	115.1	77.7	1144				
825	---		---		---	---	---	9.97	115.4	79.5	28.5	1163			
	875		---		---	---	---	10.5	114.6	80.1	28.5	1171			
895	---		---		---	---	---	10.8	115.2	80.6	28.5	1174			
	1010		---		---	---	---	12.2	115.3	82.3	28.5	1190			
62			380		---	---	---	---	---	---	4.57	114.8	65.1	3140	36.5
	685	---		---	---	---	---	8.26	115.1	76.5	27.0	1087			
	775	---		---	---	---	---	9.32	114.8	78.5	27.0	1105			
		820		---	---	---	---	9.84	114.6	79.2	27.0	1113			
	840	---		---	---	---	---	10.1	114.8	79.6	27.0	1117			
		950		---	---	---	---	11.4	114.6	81.2	27.0	1132			

Nota (\*) - VENTILAZIONE SOLO L.O. / FAN ONLY SIDE COMMUTATOR

Nota (°) - Regolazione di campo / Field weakening



Potenza eccitazione				
Excitation power	(w)	750		
Cost. tempo eccitaz.				
Field time constant	(ms)	175	Tipo	
Massa del motore			Size	MGL 132 M
Mass of the motor	(Kg)	155	Ventilazione	
Momento d'inerzia rotore			Ventilation	IC 06
Rotor inertia moment	(Kgm2)	0.113		

Avv.	Velocità nominale n/min a tensione nominale di armatura Rated speed (rev/min) at rated voltage							Potenza Power kW	Coppia vel.nomin. Torque at rated speed Nm	Rendimento Efficiency %	Circuito di armatura Armature circuit			Max giri Max. speed (°)			
	220	260	400	440	460	470	520				Corrente Current Amp	Res. 115°C mOhm	Ind. mH				
45	2410	---	---	---	---	---	---	27.1	107.4	89.9	137	86.6	1.00	3856	*		
		2880	---	---	---	---	---	32.3	107.1	90.7	137					4500	*
46	1690	---	---	---	---	---	---	25.2	142.4	87.4	131	149	1.90	2702			
		2030	---	---	---	---	---	30.3	142.5	89.0	131					3247	
		3220	---	---	---	---	---	48.0	142.3	91.6	131					4311	*
			3560	---	---	---	---	53.1	142.4	92.1	131					4367	*
		3735	---	---	---	---	---	55.7	142.4	92.4	131					4392	*
			3820	---	---	---	---	56.9	142.2	92.4	131					4404	*
		4245	---	---	---	---	---	63.3	142.4	92.9	131					4455	*
47	1360	---	---	---	---	---	---	19.8	139.0	85.7	105	226	2.83	2180			
		1645	---	---	---	---	---	23.9	138.7	87.5	105					2629	
		2625	---	---	---	---	---	38.2	139.0	91.0	105					3897	
			2905	---	---	---	---	42.3	139.0	91.6	105					3948	
		3045	---	---	---	---	44.3	138.9	91.7	105	3971						
		3115	---	---	---	---	45.3	138.9	91.8	105	3981						
48	1059	---	---	---	---	---	---	16.1	145.2	83.2	88.0	345	4.04	1755			
		1330	---	---	---	---	---	19.5	140.0	85.2	88.0					2129	
		2150	---	---	---	---	---	31.5	139.9	89.5	88.0					3224	
			2385	---	---	---	---	35.0	140.1	90.4	88.0					3267	
		2500	---	---	---	---	---	36.7	140.2	90.7	88.0					3286	
			2560	---	---	---	---	37.5	139.9	90.7	88.0					3295	
		2850	---	---	---	---	41.8	140.1	91.3	88.0	3335						
		49	920	---	---	---	---	---	---	14.0	145.3					81.6	78.0
1120	---			---	---	---	---	17.0	144.9	83.8	78.0	1794					
1825	---			---	---	---	---	27.7	144.9	88.8	78.0	2680					
	2025			---	---	---	---	30.8	145.2	89.7	78.0	2716					
2125	---			---	---	---	32.3	145.1	90.0	78.0	2732						
2175	---			---	---	---	33.0	144.9	90.0	78.0	2739						
50	780	---	---	---	---	---	---	12.0	146.9	79.1	69.0	574	7.26	1251			
		960	---	---	---	---	---	14.7	146.2	81.9	69.0					1532	
		1570	---	---	---	---	---	24.2	147.2	87.7	69.0					2319	
			1745	---	---	---	---	26.9	147.2	88.6	69.0					2350	
		1835	---	---	---	---	---	28.2	146.8	88.8	69.0					2364	
			1880	---	---	---	---	28.9	146.8	89.1	69.0					2370	
		2100	---	---	---	---	32.3	146.9	90.0	69.0	2399						
		51	680	---	---	---	---	---	---	10.4	146.0					77.5	61.0
835	---			---	---	---	---	12.8	146.4	80.7	61.0	1335					
1380	---			---	---	---	---	21.1	146.0	86.5	61.0	2067					
	1535			---	---	---	---	23.5	146.2	87.6	61.0	2096					
1615	---			---	---	---	---	24.7	146.0	88.0	61.0	2109					
	1655			---	---	---	---	25.3	146.0	88.2	61.0	2115					
1850	---			---	---	---	28.3	146.1	89.2	61.0	2141						

Nota (\*) - VENTILAZIONE SOLO L.O. / FAN ONLY SIDE COMMUTATOR

Nota (°) - Regolazione di campo / Field weakening



Potenza eccitazione Excitation power	(w)	750	Tipo Size MGL 132 M Ventilazione Ventilation IC 06
Cost. tempo eccitaz. Field time constant	(ms)	175	
Massa del motore Mass of the motor	(Kg)	155	
Momento d'inerzia rotore Rotor inertia moment	(Kgm2)	0.113	

Avv.	Velocità nominale n/min a tensione nominale di armatura Rated speed (rev/min) at rated voltage							Potenza Power kW	Coppia vel.nomin. Torque at rated speed Nm	Rendimento Efficiency %	Circuito di armatura Armature circuit			Max giri Max. speed (°)	
	220	260	400	440	460	470	520				Corrente Current Amp	Res. 115°C mOhm	Ind. mH		
52	590	---	---	---	---	---	---	9.09	147.1	75.1	55.0	896	11.30	947	
		730	---	---	---	---	---	11.2	146.5	78.3	55.0				1171
		---	1225	---	---	---	---	18.8	146.6	85.5	55.0				1854
		---	---	1365	---	---	---	20.9	146.2	86.4	55.0				1880
		---	---	---	1435	---	---	22.0	146.4	87.0	55.0				1892
		---	---	---	---	1470	---	22.6	146.8	87.4	55.0				1897
		---	---	---	---	---	---	---	---	---	---				---
53	520	---	---	---	---	---	---	8.02	147.3	72.9	50.0	1090	13.7	835	
		650	---	---	---	---	---	9.98	146.6	76.8	50.0				1039
		---	1095	---	---	---	---	19.8	172.7	99.0	50.0				1682
		---	---	1225	---	---	---	18.8	146.6	85.5	50.0				1707
		---	---	---	1290	---	---	19.8	146.6	86.1	50.0				1717
		---	---	---	---	1320	---	20.3	146.9	86.4	50.0				1722
		---	---	---	---	---	1480	22.7	146.5	87.3	50.0				1745
54	465	---	---	---	---	---	---	7.01	144.0	70.8	45.0	1310	16.2	743	
		580	---	---	---	---	---	8.77	144.4	75.0	45.0				930
		---	990	---	---	---	---	14.9	143.7	82.8	45.0				1563
		---	---	1110	---	---	---	16.7	143.7	84.3	45.0				1587
		---	---	---	1165	---	---	17.6	144.3	85.0	45.0				1597
		---	---	---	---	1195	---	18.0	143.8	85.1	45.0				1602
		---	---	---	---	---	1340	20.2	144.0	86.3	45.0				1624
55	410	---	---	---	---	---	---	6.12	142.5	67.8	41.0	1600	19.0	657	
		520	---	---	---	---	---	7.72	141.8	72.4	41.0				830
		---	895	---	---	---	---	13.3	141.9	81.1	41.0				1434
		---	---	1005	---	---	---	15.0	142.5	83.1	41.0				1478
		---	---	---	1060	---	---	15.8	142.3	83.8	41.0				1488
		---	---	---	---	1085	---	16.2	142.6	84.1	41.0				1493
		---	---	---	---	---	1220	18.2	142.5	85.4	41.0				1514
56	375	---	---	---	---	---	---	5.76	146.7	66.3	39.5	1750	22.0	596	
		475	---	---	---	---	---	7.31	147.0	71.2	39.5				757
		---	825	---	---	---	---	12.7	147.0	80.4	39.5				1318
		---	---	925	---	---	---	14.3	147.6	82.3	39.5				1369
		---	---	---	975	---	---	15.1	147.9	83.1	39.5				1378
		---	---	---	---	1000	---	15.4	147.1	83.0	39.5				1383
		---	---	---	---	---	1125	17.4	147.7	84.7	39.5				1402
57	340	---	---	---	---	---	---	5.30	148.9	65.1	37.0	1950	25.3	546	
		435	---	---	---	---	---	6.75	148.2	70.2	37.0				696
		---	760	---	---	---	---	11.8	148.3	79.7	37.0				1215
		---	---	855	---	---	---	13.3	148.5	81.7	37.0				1234
		---	---	---	905	---	---	14.0	147.7	82.3	37.0				1243
		---	---	---	---	925	---	14.4	148.7	82.8	37.0				1247
		---	---	---	---	---	1045	16.2	148.0	84.2	37.0				1264
58	395	---	---	---	---	---	---	6.02	145.5	68.1	34.0	2280	28.8	634	
		705	---	---	---	---	---	10.7	144.9	78.7	34.0				1125
		---	---	---	---	---	---	12.0	145.1	80.2	34.0				1175
		---	---	---	835	---	---	12.7	145.2	81.2	34.0				1183
		---	---	---	---	855	---	13.0	145.2	81.4	34.0				1187
		---	---	---	---	---	---	14.7	145.5	83.1	34.0				1205
		---	---	---	---	---	---	---	---	---	---				---

Nota (\*) - VENTILAZIONE SOLO L.O. / FAN ONLY SIDE COMMUTATOR

Nota (°) - Regolazione di campo / Field weakening



Potenza eccitazione Excitation power (w)	750	Tipo Size MGL 132 M Ventilazione Ventilation IC 06
Cost. tempo eccitaz. Field time constant (ms)	175	
Massa del motore Mass of the motor (Kg)	155	
Momento d'inerzia rotore Rotor inertia moment (Kgm2)	0.113	

Avv.	Velocità nominale n/min a tensione nominale di armatura Rated speed (rev/min) at rated voltage							Potenza Power kW	Coppia vel. nomin. Torque at rated speed Nm	Rendimento Efficiency %	Circuito di armatura Armature circuit			Max giri Max. speed (°)
	220	260	400	440	460	470	520				Corrente Current Amp	Res. 115°C mOhm	Ind. mH	
59		360	---	---	---	---	---	5.46	144.8	65.6	32.0	2620	32.3	575
			650	---	---	---	---	9.9	144.9	77.0	32.0			1037
				730	---	---	---	11.1	145.2	78.8	32.0			1103
					770	---	---	11.7	145.1	79.5	32.0			1111
						795	---	12.1	145.3	80.5	32.0			1115
							895	13.6	145.1	81.7	32.0			1132
60		335	---	---	---	---	---	5.05	144.0	64.7	30.0	2870	36.5	536
			610	---	---	---	---	9.17	143.6	76.4	30.0			972
				685	---	---	---	10.3	143.6	78.0	30.0			1048
					725	---	---	10.9	143.6	79.0	30.0			1055
						745	---	11.2	143.6	79.4	30.0			1059
							840	12.7	144.4	81.4	30.0			1075
61			565	---	---	---	---	8.59	145.2	75.4	28.5	3180	40.6	908
				640	---	---	---	9.71	144.9	77.4	28.5			988
					680	---	---	10.3	144.6	78.6	28.5			996
						695	---	10.6	145.6	79.1	28.5			999
							790	11.9	143.8	80.3	28.5			1015
62			530	---	---	---	---	7.98	143.8	73.9	27.0	3570	45.2	846
				600	---	---	---	9.04	143.9	76.1	27.0			939
					635	---	---	9.57	143.9	77.1	27.0			946
						650	---	9.83	144.4	77.5	27.0			950
							740	11.2	144.5	79.8	27.0			965

Nota (\*) - VENTILAZIONE SOLO L.O. / FAN ONLY SIDE COMMUTATOR

Nota (°) - Regolazione di campo / Field weakening



Potenza eccitazione Excitation power (w) 850				
Cost. tempo eccitaz. Field time constant (ms) 190				
Massa del motore Mass of the motor (Kg) 175				
Momento d'inerzia rotore Rotor inertia moment (Kgm2) 0.134				
	Tipo Size MGL 132 L			
	Ventilazione Ventilation IC 06			

Avv.	Velocità nominale n/min a tensione nominale di armatura Rated speed (rev/min) at rated voltage							Potenza Power kW	Coppia vel.nomin. Torque at rated speed Nm	Rendimento Efficiency %	Circuito di armatura Armature circuit			Max giri Max. speed (°)		
	220	260	400	440	460	470	520				Corrente Current Amp	Res. 115°C mOhm	Ind. mH			
45	1910	---	---	---	---	---	---	27.0	135.0	89.6	137	100	1.24	3057	*	
		2285	---	---	---	---	---	32.3	135.0	90.7	137					3656
			3595	---	---	---	---	50.8	134.9	92.7	137					4500
				3970	---	---	---	56.1	134.9	93.1	137					4500
					4155	---	---	58.8	135.1	93.3	137					4500
						4250	---	60.1	135.0	93.3	137					4500
46	1330	---	---	---	---	---	---	24.9	178.8	86.4	131	172	2.36	2129	*	
		1605	---	---	---	---	---	30.0	178.5	88.1	131					2565
			2555	---	---	---	---	47.9	179.0	91.4	131					3641
				2830	---	---	---	53.0	178.8	92.0	131					3692
					2965	---	---	55.6	179.1	92.3	131					3714
						3035	---	56.8	178.7	92.3	131					3725
47	1070	---	---	---	---	---	---	19.5	174.0	84.4	105	261	3.51	1712		
		1295	---	---	---	---	---	23.6	174.0	86.4	105					2071
			2080	---	---	---	---	38.0	174.5	90.5	105					3290
				2305	---	---	---	42.1	174.4	91.1	105					3337
					2415	---	---	44.2	174.8	91.5	105					3357
						2475	---	45.2	174.4	91.6	105					3367
48	855	---	---	---	---	---	---	15.7	175.3	81.1	88.0	399	5.02	1369		
		1045	---	---	---	---	---	19.2	175.5	83.9	88.0					1668
			1700	---	---	---	---	31.2	175.3	88.6	88.0					2716
				1885	---	---	---	34.7	175.8	89.6	88.0					2760
					1980	---	---	36.4	175.6	89.9	88.0					2777
						2025	---	37.3	175.9	90.2	88.0					2786
49	715	---	---	---	---	---	---	13.7	183.0	79.8	78.0	505	6.86	1146		
		875	---	---	---	---	---	16.7	182.3	82.3	78.0					1402
			1440	---	---	---	---	27.4	181.7	87.8	78.0					2262
				1600	---	---	---	30.5	182.0	88.9	78.0					2294
					1680	---	---	32.0	181.9	89.2	78.0					2309
						1720	---	32.8	182.1	89.5	78.0					2316
50	605	---	---	---	---	---	---	11.7	184.7	77.1	69.0	661	9.02	967		
		745	---	---	---	---	---	14.4	184.6	80.3	69.0					1192
			1235	---	---	---	---	23.9	184.8	86.6	69.0					1955
				1375	---	---	---	26.6	184.7	87.6	69.0					1985
					1445	---	---	27.9	184.4	87.9	69.0					1997
						1480	---	28.6	184.5	88.2	69.0					2003
51	520	---	---	---	---	---	---	10.0	183.6	74.5	61.0	830	11.4	835		
		645	---	---	---	---	---	12.4	183.6	78.2	61.0					1035
			1085	---	---	---	---	20.8	183.1	85.2	61.0					1733
				1210	---	---	---	23.2	183.1	86.4	61.0					1769
					1270	---	---	24.4	183.5	87.0	61.0					1781
						1300	---	25.0	183.6	87.2	61.0					1787
					1460	28.0	183.1	88.3	61.0	1811						

Nota (\*) - VENTILAZIONE SOLO L.O. / FAN ONLY SIDE COMMUTATOR

Nota (°) - Regolazione di campo / Field weakening





Potenza eccitazione Excitation power	(w)	850	Tipo		
Cost. tempo eccitaz. Field time constant	(ms)	190	Size	MGL	132 L
Massa del motore Mass of the motor	(Kg)	175	Ventilazione Ventilation		IC 06
Momento d'inerzia rotore Rotor inertia moment	(Kgm2)	0.134			

Avv.	Velocità nominale n/min a tensione nominale di armatura Rated speed (rev/min) at rated voltage							Potenza Power kW	Coppia vel.nomin. Torque at rated speed Nm	Rendimento Efficiency %	Circuito di armatura Armature circuit			Max giri Max. speed (°)	
	220	260	400	440	460	470	520				Corrente Current Amp	Res. 115°C mOhm	Ind. mH		
52	455	---	---	---	---	---	---	8.72	183.0	72.1	55.0	1030	14.10	724	
		565	---	---	---	---	---	10.9	184.2	76.2				904	
		960	---	---	---	---	---	18.4	183.0	83.6				55.0	1533
			1070	---	---	---	---	20.6	183.8	85.1				55.0	1587
		1125	---	---	---	---	---	21.7	184.2	85.8				55.0	1597
			1155	---	---	---	---	22.2	183.5	85.9				55.0	1602
53	395	---	---	---	---	---	---	7.64	184.7	69.5	50.0	1250	17.0	634	
		500	---	---	---	---	---	9.60	183.3	73.8				798	
		855	---	---	---	---	---	16.5	184.3	82.5				50.0	1369
			960	---	---	---	---	18.4	183.0	83.6				50.0	1439
		1010	---	---	---	---	---	19.4	183.4	84.3				50.0	1449
			1035	---	---	---	---	19.9	183.6	84.7				50.0	1454
54	350	---	---	---	---	---	---	6.63	180.9	67.0	45.0	1510	20.1	561	
		445	---	---	---	---	---	8.40	180.3	71.8				710	
		770	---	---	---	---	---	14.6	181.1	81.1				45.0	1235
			865	---	---	---	---	16.4	181.1	82.8				45.0	1338
		910	---	---	---	---	---	17.2	180.5	83.1				45.0	1347
			935	---	---	---	---	17.7	180.8	83.7				45.0	1352
55	305	---	---	---	---	---	---	5.73	179.4	63.5	41.0	1850	23.6	491	
		395	---	---	---	---	---	7.34	177.4	68.9				629	
		695	---	---	---	---	---	13.0	178.6	79.3				41.0	1113
			780	---	---	---	---	14.6	178.7	80.9				41.0	1245
		825	---	---	---	---	---	15.4	178.3	81.7				41.0	1254
			845	---	---	---	---	15.8	178.6	82.0				41.0	1259
56	277	---	---	---	---	---	---	5.37	185.1	61.8	39.5	2020	27.4	443	
		355	---	---	---	---	---	6.92	186.1	67.4				572	
		640	---	---	---	---	---	12.4	185.0	78.5				39.5	1021
			720	---	---	---	---	13.9	184.4	80.0				39.5	1149
		760	---	---	---	---	---	14.7	184.7	80.9				39.5	1164
			780	---	---	---	---	15.1	184.9	81.3				39.5	1168
57	330	---	---	---	---	---	---	5.37	185.1	61.8	37.0	2240	31.4	443	
		590	---	---	---	---	---	6.92	186.1	67.4				572	
		665	---	---	---	---	---	12.4	185.0	78.5				39.5	1021
			720	---	---	---	---	13.9	184.4	80.0				39.5	1149
		760	---	---	---	---	---	14.7	184.7	80.9				39.5	1164
			780	---	---	---	---	15.1	184.9	81.3				39.5	1168
58	540	---	---	---	---	---	---	5.37	185.1	61.8	37.0	2620	35.7	443	
		610	---	---	---	---	---	6.92	186.1	67.4				572	
		645	---	---	---	---	---	12.4	185.0	78.5				39.5	1021
			665	---	---	---	---	13.9	184.4	80.0				39.5	1149
		750	---	---	---	---	---	14.7	184.7	80.9				39.5	1164
			750	---	---	---	---	15.1	184.9	81.3				39.5	1168

Nota (\*) - VENTILAZIONE SOLO L.O. / FAN ONLY SIDE COMMUTATOR

Nota (°) - Regolazione di campo / Field weakening



Potenza eccitazione Excitation power (w)	850	Tipo Size MGL 132 L Ventilazione Ventilation IC 06
Cost. tempo eccitaz. Field time constant (ms)	190	
Massa del motore Mass of the motor (Kg)	175	
Momento d'inerzia rotore Rotor inertia moment (Kgm2)	0.134	

Avv.	Velocità nominale n/min a tensione nominale di armatura Rated speed (rev/min) at rated voltage							Potenza Power kW	Coppia vel. nomin. Torque at rated speed Nm	Rendimento Efficiency %	Circuito di armatura Armature circuit			Max giri Max. speed (°)
	220	260	400	440	460	470	520				Corrente Current Amp	Res. 115°C mOhm	Ind. mH	
59			495	---	---	---	---	9.5	182.9	74.1	32.0	3020	40.1	796
				565	---	---	---	10.7	180.8	76.0	32.0			902
					595	---	---	11.4	183.0	77.4	32.0			935
						615	---	11.7	181.7	77.8	32.0			939
						695	---	13.3	182.7	79.9	32.0			955
60			465	---	---	---	---	8.82	181.1	73.5	30.0	3310	45.4	745
				530	---	---	---	10.0	180.2	75.8	30.0			845
					560	---	---	10.6	180.8	76.8	30.0			888
						575	---	10.9	181.0	77.3	30.0			891
						655	---	12.4	180.8	79.5	30.0			907
61			435	---	---	---	---	8.23	180.7	72.2	28.5	3660	50.5	694
				495	---	---	---	9.36	180.6	74.6	28.5			789
					525	---	---	9.92	180.4	75.7	28.5			836
						535	---	10.2	182.1	76.1	28.5			841
						610	---	11.6	181.6	78.3	28.5			856
62			405	---	---	---	---	7.62	179.7	70.6	27.0	4120	56.2	644
				460	---	---	---	8.68	180.2	73.1	27.0			734
					485	---	---	9.21	181.3	74.2	27.0			779
						500	---	9.48	181.1	74.7	27.0			799
						570	---	10.8	180.9	76.9	27.0			813

Nota (\*) - VENTILAZIONE SOLO L.O. / FAN ONLY SIDE COMMUTATOR

Nota (°) - Regolazione di campo / Field weakening



Potenza eccitazione Excitation power	(w)	950	Tipo Size	MGL	132	P
Cost. tempo eccitaz. Field time constant	(ms)	209	Ventilazione Ventilation			IC 06
Massa del motore Mass of the motor	(Kg)	195				
Momento d'inerzia rotore Rotor inertia moment	(Kgm2)	0.155				

Avv.	Velocità nominale n/min a tensione nominale di armatura Rated speed (rev/min) at rated voltage							Potenza Power kW	Coppia vel.nomin. Torque at rated speed Nm	Rendimento Efficiency %	Circuito di armatura Armature circuit			Max giri Max. speed (°)	
	220	260	400	440	460	470	520				Corrente Current Amp	Res. 115°C mOhm	Ind. mH		
45	1575	---	---	---	---	---	---	26.9	163.1	89.3	137	114	1.48	2524	*
		1890	---	---	---	---	---	32.2	162.7	90.4	137			3023	
			2980	---	---	---	---	50.8	162.8	92.7	137			3500	
				3295	---	---	---	56.2	162.9	93.2	137			3500	
					3450	---	---	58.8	162.8	93.3	137			3500	
46	1090	---	---	---	---	---	---	24.6	215.5	85.4	131	195	2.82	1747	*
		1320	---	---	---	---	---	29.8	215.6	87.5	131			2110	
			2115	---	---	---	---	47.7	215.4	91.0	131			3150	
				2340	---	---	---	52.8	215.5	91.6	131			3196	
					2455	---	---	55.4	215.5	91.9	131			3216	
						2510	---	56.7	215.7	92.1	131			3226	
							2795	63.1	215.6	92.6	131			3269	
47	875	---	---	---	---	---	---	19.2	209.5	83.1	105	295	4.19	1400	*
		1060	---	---	---	---	---	23.4	210.8	85.7	105			1699	
			1715	---	---	---	---	37.8	210.5	90.0	105			2747	
				1905	---	---	---	41.9	210.0	90.7	105			2888	
					2000	---	---	43.9	209.6	90.9	105			2907	
						2045	---	45.0	210.1	91.2	105			2915	
48	695	---	---	---	---	---	---	15.4	211.6	79.5	88.0	452	6.00	1111	*
		850	---	---	---	---	---	18.8	211.2	82.2	88.0			1361	
			1395	---	---	---	---	30.9	211.5	87.8	88.0			2234	
				1550	---	---	---	34.4	211.9	88.8	88.0			2387	
					1630	---	---	36.1	211.5	89.2	88.0			2404	
						1670	---	37.0	211.6	89.5	88.0			2411	
							1865	41.3	211.5	90.3	88.0			2445	
49	580	---	---	---	---	---	---	13.3	219.0	77.5	78.0	571	8.20	927	*
		715	---	---	---	---	---	16.4	219.0	80.9	78.0			1141	
			1180	---	---	---	---	27.1	219.3	86.9	78.0			1889	
				1315	---	---	---	30.2	219.3	88.0	78.0			1985	
					1380	---	---	31.7	219.4	88.4	78.0			1998	
						1415	---	32.4	218.7	88.4	78.0			2004	
50	485	---	---	---	---	---	---	11.3	222.5	74.4	69.0	747	10.80	778	*
		605	---	---	---	---	---	14.0	221.0	78.0	69.0			965	
			1015	---	---	---	---	23.5	221.1	85.1	69.0			1620	
				1130	---	---	---	26.2	221.4	86.3	69.0			1716	
					1190	---	---	27.6	221.5	87.0	69.0			1728	
						1215	---	28.3	222.4	87.3	69.0			1733	
							1365	31.7	221.8	88.4	69.0			1758	
51	420	---	---	---	---	---	---	9.65	219.4	71.9	61.0	938	13.6	668	*
		520	---	---	---	---	---	12.1	222.2	76.3	61.0			835	
			885	---	---	---	---	20.5	221.2	84.0	61.0			1417	
				990	---	---	---	22.9	220.9	85.3	61.0			1529	
					1040	---	---	24.1	221.3	85.9	61.0			1540	
						1065	---	24.7	221.5	86.2	61.0			1545	
							1195	27.7	221.4	87.3	61.0			1568	

Nota (\*) - VENTILAZIONE SOLO L.O. / FAN ONLY SIDE COMMUTATOR

Nota (°) - Regolazione di campo / Field weakening



Potenza eccitazione Excitation power	(w)	950	Tipo		
Cost. tempo eccitaz. Field time constant	(ms)	209	Size	MGL	132 P
Massa del motore Mass of the motor	(Kg)	195	Ventilazione Ventilation		IC 06
Momento d'inerzia rotore Rotor inertia moment	(Kgm2)	0.155			

Avv.	Velocità nominale n/min a tensione nominale di armatura Rated speed (rev/min) at rated voltage							Potenza Power kW	Coppia vel.nomin. Torque at rated speed Nm	Rendimento Efficiency %	Circuito di armatura Armature circuit			Max giri Max. speed (°)
	220	260	400	440	460	470	520				Corrente Current Amp	Res. 115°C mOhm	Ind. mH	
52	360	---	---	---	---	---	---	8.33	221.0	68.8	55.0	1170	16.8	576
		455	---	---	---	---	---	10.5	220.4	73.4	55.0			725
		780	---	---	---	---	---	18.1	221.6	82.3	55.0			1249
		875	---	---	---	---	---	20.2	220.5	83.5	55.0			1371
		920	---	---	---	---	---	21.3	221.1	84.2	55.0			1381
		945	---	---	---	---	---	21.9	221.3	84.7	55.0			1386
53	315	---	---	---	---	---	---	7.25	219.8	65.9	50.0	1420	20.3	501
		400	---	---	---	---	---	9.22	220.1	70.9	50.0			637
		695	---	---	---	---	---	16.1	221.2	80.5	50.0			1113
		780	---	---	---	---	---	18.1	221.6	82.3	50.0			1243
		825	---	---	---	---	---	19.1	221.1	83.0	50.0			1252
		845	---	---	---	---	---	19.6	221.5	83.4	50.0			1257
54	355	---	---	---	---	---	---	8.02	215.7	68.5	45.0	1710	24.1	564
		625	---	---	---	---	---	14.2	217.0	78.9	45.0			1001
		705	---	---	---	---	---	16.0	216.7	80.8	45.0			1126
		740	---	---	---	---	---	16.9	218.1	81.6	45.0			1164
		760	---	---	---	---	---	17.3	217.4	81.8	45.0			1168
		860	---	---	---	---	---	19.5	216.5	83.3	45.0			1187
55	310	---	---	---	---	---	---	6.96	214.4	65.3	41.0	2090	28.2	496
		560	---	---	---	---	---	12.6	214.9	76.8	41.0			899
		635	---	---	---	---	---	14.2	213.5	78.7	41.0			1014
		670	---	---	---	---	---	15.0	213.8	79.5	41.0			1072
		690	---	---	---	---	---	15.4	213.1	79.9	41.0			1087
		780	---	---	---	---	---	17.5	214.2	82.1	41.0			1105
56	515	---	---	---	---	---	---	12.0	222.5	75.9	39.5	2290	32.7	822
		580	---	---	---	---	---	13.5	222.3	77.7	39.5			929
		615	---	---	---	---	---	14.3	222.0	78.7	39.5			983
		630	---	---	---	---	---	14.7	222.8	79.2	39.5			1009
		715	---	---	---	---	---	16.6	221.7	80.8	39.5			1027
57	475	---	---	---	---	---	---	11.1	223.2	75.0	37.0	2530	37.5	759
		535	---	---	---	---	---	12.6	224.9	77.4	37.0			859
		570	---	---	---	---	---	13.3	222.8	78.1	37.0			903
		585	---	---	---	---	---	13.6	222.0	78.2	37.0			907
		660	---	---	---	---	---	15.5	224.3	80.6	37.0			922
58	435	---	---	---	---	---	---	9.96	218.6	73.2	34.0	2960	42.7	695
		495	---	---	---	---	---	11.3	218.0	75.5	34.0			789
		520	---	---	---	---	---	12.0	220.4	76.7	34.0			835
		535	---	---	---	---	---	12.3	219.5	77.0	34.0			859
		610	---	---	---	---	---	14.0	219.2	79.2	34.0			878

Nota (\*) - VENTILAZIONE SOLO L.O. / FAN ONLY SIDE COMMUTATOR

Nota (°) - Regolazione di campo / Field weakening



Potenza eccitazione Excitation power (w)	950	Tipo Size MGL 132 P Ventilazione Ventilation IC 06
Cost. tempo eccitaz. Field time constant (ms)	209	
Massa del motore Mass of the motor (Kg)	195	
Momento d'inerzia rotore Rotor inertia moment (Kgm2)	0.155	

Avv.	Velocità nominale n/min a tensione nominale di armatura Rated speed (rev/min) at rated voltage							Potenza Power kW	Coppia vel. nomin. Torque at rated speed Nm	Rendimento Efficiency %	Circuito di armatura Armature circuit			Max giri Max. speed (°)
	220	260	400	440	460	470	520				Corrente Current Amp	Res. 115°C mOhm	Ind. mH	
59			395	---	---	---	---	9.10	220.0	71.1	32.0	3420	47.9	635 723 767 789 824
			450	---	---	---	10.4	220.7	73.9	32.0				
			480	---	---	---	11.0	218.8	74.7	32.0				
			495	---	---	---	11.3	218.0	75.1	32.0				
			560	---	---	---	12.9	220.0	77.5	32.0				
60			370	---	---	---	---	8.45	218.1	70.4	30.0	3740	54.2	594 677 719 740 783
			425	---	---	---	9.63	216.4	73.0	30.0				
			450	---	---	---	10.2	216.5	73.9	30.0				
			460	---	---	---	10.5	218.0	74.5	30.0				
			525	---	---	---	12.0	218.3	76.9	30.0				
61			345	---	---	---	---	7.87	217.8	69.0	28.5	4130	60.3	552 631 670 690 738
			395	---	---	---	8.99	217.3	71.7	28.5				
			420	---	---	---	9.55	217.1	72.8	28.5				
			430	---	---	---	9.84	218.5	73.5	28.5				
			495	---	---	---	11.2	216.1	75.6	28.5				
62			320	---	---	---	---	7.24	216.1	67.0	27.0	4660	67.1	509 584 622 640 701
			365	---	---	---	8.31	217.4	69.9	27.0				
			390	---	---	---	8.84	216.5	71.2	27.0				
			400	---	---	---	9.11	217.5	71.8	27.0				
			460	---	---	---	10.4	215.9	74.1	27.0				

Nota (\*) - VENTILAZIONE SOLO L.O. / FAN ONLY SIDE COMMUTATOR

Nota (°) - Regolazione di campo / Field weakening



Potenza eccitazione Excitation power	(w)	920	Tipo Size	MGL	160	K
Cost. tempo eccitaz. Field time constant	(ms)	209	Ventilazione Ventilation			IC 06
Massa del motore Mass of the motor	(Kg)	220				
Momento d'inerzia rotore Rotor inertia moment	(Kgm2)	0.2				

Avv.	Velocità nominale n/min a tensione nominale di armatura Rated speed (rev/min) at rated voltage							Potenza Power kW	Coppia vel.nomin. Torque at rated speed Nm	Rendimento Efficiency %	Circuito di armatura Armature circuit			Max giri Max. speed (°)		
	220	400	440	460	470	520	600				Corrente Current Amp	Res. 115°C mOhm	Ind. mH			
45	2355	---	---	---	---	---	---	41.8	170	89.6	212	60.2	1.10	3768	*	
		4420	---	---	---	---	---	63.8	138	92.2	173			4500	*	
46	1930	---	---	---	---	---	---	35.9	178	88.7	184	86.5	1.57	3092	*	
		3655	---	---	---	---	---	67.8	177	92.1	184			4500	*	
		4035	---	---	---	---	---	---	74.9	177	92.5			184	4500	*
			4230	---	---	---	---	---	77.1	174	92.6			181	4500	*
			4325	---	---	---	---	---	77.1	170	92.7			177	4500	*
47	1630	---	---	---	---	---	---	30.8	180	87.5	160	118	2.14	2612		
		3110	---	---	---	---	---	58.6	180	91.6	160			3933		
		3435	---	---	---	---	---	---	64.8	180	92.0			160	3981	
			3600	---	---	---	---	---	67.9	180	92.3			160	4002	
			3680	---	---	---	---	---	69.5	180	92.4			160	4012	
48	1410	---	---	---	---	---	---	26.8	182	86.4	141	152	2.77	2255		
		2700	---	---	---	---	---	51.4	182	91.1	141			3417		
		2990	---	---	---	---	---	---	56.9	182	91.7			141	3459	
			3130	---	---	---	---	---	59.6	182	91.9			141	3478	
		3205	---	---	---	---	---	---	61.0	182	92.0			141	3486	
			3560	---	---	---	---	---	67.8	182	92.5			141	3562	
49	1235	---	---	---	---	---	---	23.4	181	85.1	125	195	3.58	1974		
		2380	---	---	---	---	---	45.2	181	90.4	125			3041		
		2635	---	---	---	---	---	---	50.1	182	91.1			125	3079	
			2765	---	---	---	---	---	52.5	181	91.3			125	3096	
		2830	---	---	---	---	---	---	53.7	181	91.4			125	3104	
			3145	---	---	---	---	---	59.7	181	91.8			125	3147	
		3655	---	---	---	---	---	66.5	174	92.4	120			3657		
50	1130	---	---	---	---	---	---	21.2	179	84.5	114	227	4.18	1807		
		2190	---	---	---	---	---	41.1	179	90.1	114			3500		
		2425	---	---	---	---	---	---	45.5	179	90.7			114	3877	
			2540	---	---	---	---	---	47.7	179	91.0			114	4065	
		2600	---	---	---	---	---	---	48.8	179	91.1			114	4159	
			2895	---	---	---	---	---	54.3	179	91.6			114	4500	
51	985	---	---	---	---	---	---	18.7	181	83.3	102	286	5.32	1575		
		1925	---	---	---	---	---	36.4	181	89.2	102			2490		
		2135	---	---	---	---	---	---	40.4	181	90.0			102	2522	
			2235	---	---	---	---	---	42.4	181	90.4			102	2536	
		2290	---	---	---	---	---	---	43.4	181	90.5			102	2543	
			2550	---	---	---	---	---	48.3	181	91.1			102	2572	
		2965	---	---	---	---	---	54.4	175	92.0	98.6			2967		

Nota (\*) - VENTILAZIONE SOLO L.O. / FAN ONLY SIDE COMMUTATOR

Nota (°) - Regolazione di campo / Field weakening



Potenza eccitazione Excitation power	(w)	920	Tipo Size	MGL	160	K	
Cost. tempo eccitaz. Field time constant	(ms)	209					
Massa del motore Mass of the motor	(Kg)	220	Ventilazione Ventilation				IC 06
Momento d'inerzia rotore Rotor inertia moment	(Kgm2)	0.2					

Avv.	Velocità nominale n/min a tensione nominale di armatura Rated speed (rev/min) at rated voltage							Potenza Power kW	Coppia vel.nomin. Torque at rated speed Nm	Rendimento Efficiency %	Circuito di armatura Armature circuit			Max giri Max. speed (°)
	220	400	440	460	470	520	600				Corrente Current Amp	Res. 115°C mOhm	Ind. mH	
52	915	---	---	---	---	---	---	17.4	182	82.4	96.0	327	6.0	1462
		1795	---	---	---	---	---	34.1	181	88.8	96.0			
		---	1990	---	---	---	---	37.8	181	89.5	96.0			
		---	---	2090	---	---	---	39.7	181	89.9	96.0			
		---	---	---	2140	---	---	40.6	181	90.0	96.0			
		---	---	---	---	2385	---	45.3	181	90.7	96.0			
		---	---	---	---	---	2775	52.7	181	91.5	96.0			
		---	---	---	---	---	---	---	---	---	---			
53	810	---	---	---	---	---	---	15.4	182	80.5	87.0	402	7.4	1292
		1600	---	---	---	---	---	30.6	183	87.9	87.0			
		---	1780	---	---	---	---	34.0	182	88.8	87.0			
		---	---	1865	---	---	---	35.7	183	89.2	87.0			
		---	---	---	1910	---	---	36.5	183	89.3	87.0			
		---	---	---	---	2130	---	40.7	183	90.0	87.0			
		---	---	---	---	---	---	---	---	---	---			
		---	---	---	---	---	---	---	---	---	---			
54	760	---	---	---	---	---	---	14.4	181	79.8	82.0	448	8.2	1217
		1515	---	---	---	---	---	28.7	181	87.5	82.0			
		---	1685	---	---	---	---	31.9	181	88.4	82.0			
		---	---	1770	---	---	---	33.5	181	88.8	82.0			
		---	---	---	1810	---	---	34.3	181	89.0	82.0			
		---	---	---	---	---	---	---	---	---	---			
55	645	---	---	---	---	---	---	12.3	182	77.7	72.0	580	10.7	1036
		1310	---	---	---	---	---	24.9	182	86.5	72.0			
		---	1455	---	---	---	---	27.7	182	87.4	72.0			
		---	---	1530	---	---	---	29.1	182	87.9	72.0			
		---	---	---	1565	---	---	29.8	182	88.1	72.0			
		---	---	---	---	1750	---	33.2	181	88.7	72.0			
56	555	---	---	---	---	---	---	10.6	182	75.3	64.0	740	13.4	891
		1145	---	---	---	---	---	21.8	182	85.2	64.0			
		---	1275	---	---	---	---	24.2	181	85.9	64.0			
		---	---	1340	---	---	---	25.5	182	86.6	64.0			
		---	---	---	1375	---	---	26.1	181	86.8	64.0			
		---	---	---	---	1535	---	29.3	182	88.0	64.0			
		---	---	---	---	---	1800	34.2	181	89.1	64.0			
		---	---	---	---	---	---	---	---	---	---			
57	490	---	---	---	---	---	---	9.25	180	73.1	57.5	905	16.8	780
		1015	---	---	---	---	---	19.3	182	83.9	57.5			
		---	1135	---	---	---	---	21.5	181	85.0	57.5			
		---	---	1195	---	---	---	22.6	181	85.4	57.5			
		---	---	---	1225	---	---	23.2	181	85.8	57.5			
		---	---	---	---	1370	---	26.0	181	87.0	57.5			
		---	---	---	---	---	---	---	---	---	---			
58	430	---	---	---	---	---	---	8.09	180	70.7	52.0	1110	20.2	686
		910	---	---	---	---	---	17.2	181	82.7	52.0			
		---	1015	---	---	---	---	19.20	181	83.9	52.0			
		---	---	1070	---	---	---	20.2	180	84.4	52.0			
		---	---	---	1095	---	---	20.7	181	84.7	52.0			
		---	---	---	---	1230	---	23.2	180	85.8	52.0			
		---	---	---	---	---	---	---	---	---	---			

Nota (\*) - VENTILAZIONE SOLO L.O. / FAN ONLY SIDE COMMUTATOR

Nota (°) - Regolazione di campo / Field weakening



Potenza eccitazione Excitation power (w)	920	Tipo	
Cost. tempo eccitaz. Field time constant (ms)	209	Size	MGL 160 K
Massa del motore Mass of the motor (Kg)	220	Ventilazione Ventilation	IC 06
Momento d'inerzia rotore Rotor inertia moment (Kgm2)	0.2		

Avv.	Velocità nominale n/min a tensione nominale di armatura Rated speed (rev/min) at rated voltage							Potenza Power kW	Coppia vel. nomin. Torque at rated speed Nm	Rendimento Efficiency %	Circuito di armatura Armature circuit			Max giri Max. speed (°)	
	220	400	440	460	470	520	600				Corrente Current Amp	Res. 115°C mOhm	Ind. mH		
59	380	---	---	---	---	---	---	7.42	187	68.8	49.0	1270	24.2	611	
		825	---	---	---	---	---	16.0	185	81.6	49.0				1317
			920	---	---	---	---	17.9	186	83.0	49.0				1474
				970	---	---	---	18.8	185	83.4	49.0				1552
					995	---	---	19.3	185	83.8	49.0				1591
						1115	---	21.7	186	85.2	49.0				1787
							1315	25.5	185	86.7	49.0				2101
60	345	---	---	---	---	---	---	6.71	186	67.0	45.5	1450	27.7	549	
		750	---	---	---	---	---	14.7	187	80.8	45.5				1201
			840	---	---	---	---	16.4	186	81.9	45.5				1346
				885	---	---	---	17.3	187	82.7	45.5				1418
					910	---	---	17.8	187	83.2	45.5				1454
						1020	---	20.0	187	84.5	45.5				1635
61	305	---	---	---	---	---	---	5.88	184	64.4	41.5	1740	32.9	490	
		685	---	---	---	---	---	13.1	183	78.9	41.5				1095
			770	---	---	---	---	14.8	184	81.1	41.5				1229
				810	---	---	---	15.6	184	81.7	41.5				1296
					830	---	---	16.0	184	82.0	41.5				1330
						935	---	18.0	184	83.4	41.5				1498
							1105	21.2	183	85.1	41.5				1767
62	274	---	---	---	---	---	---	5.17	180	61.8	38	2050	38.3	439	
		625	---	---	---	---	---	11.8	180	77.6	38.0				1003
			705	---	---	---	---	13.3	180	79.5	38.0				1129
				745	---	---	---	14.0	179	80.1	38.0				1192
					765	---	---	14.4	180	80.6	38.0				1223
						860	---	16.2	180	82.0	38.0				1380
							1020	19.2	180	84.2	38.0				1631

Nota (\*) - VENTILAZIONE SOLO L.O. / FAN ONLY SIDE COMMUTATOR

Nota (°) - Regolazione di campo / Field weakening





Potenza eccitazione Excitation power	(w)	1000	Tipo		
Cost. tempo eccitaz. Field time constant	(ms)	230	Size	MGL	160 S
Massa del motore Mass of the motor	(Kg)	238	Ventilazione Ventilation		IC 06
Momento d'inerzia rotore Rotor inertia moment	(Kgm2)	0.23			

Avv.	Velocità nominale n/min a tensione nominale di armatura Rated speed (rev/min) at rated voltage							Potenza Power kW	Coppia vel.nomin. Torque at rated speed Nm	Rendimento Efficiency %	Circuito di armatura Armature circuit			Max giri Max. speed (°)	
	220	400	440	460	470	520	600				Corrente Current Amp	Res. 115°C mOhm	Ind. mH		
45	1950	---	---	---	---	---	---	41.8	205	89.6	212	66.4	1.31	3120	*
		3670	---	---	---	---	---	75.6	197	92.6	204			4500	*
			4055	---	---	---	---	77.0	181	93.1	188			4500	*
				4245	---	---	---	77.2	174	93.2	180			4500	*
					4340	---	---	77.2	170	93.3	176			4500	*
46	1595	---	---	---	---	---	---	35.8	214	88.4	184	95.4	1.87	2555	*
		3030	---	---	---	---	---	67.9	214	92.3	184			4100	*
			3350	---	---	---	---	75.0	214	92.6	184			4154	*
				3510	---	---	---	78.6	214	92.9	184			4177	*
					3590	---	---	80.4	214	93.0	184			4188	*
				3990	---	89.3	214	93.3	184	4238	*				
47	1345	---	---	---	---	---	---	30.6	217	86.9	160	130	2.55	2155	
		2575	---	---	---	---	---	58.6	217	91.6	160			3467	
			2850	---	---	---	---	64.8	217	92.0	160			3512	
				2985	---	---	---	68.0	218	92.4	160			3532	
					3055	---	---	69.5	217	92.4	160			3542	
48	1160	---	---	---	---	---	---	26.6	219	85.8	141	167	3.30	1859	
		2240	---	---	---	---	---	51.3	219	91.0	141			3012	
			2475	---	---	---	---	56.8	219	91.6	141			3052	
				2595	---	---	---	59.6	219	91.9	141			3069	
					2655	---	---	60.9	219	91.9	141			3077	
				2955	---	67.8	219	92.5	141	3114					
49	1015	---	---	---	---	---	---	23.2	218	84.4	125	215	4.27	1624	
		1970	---	---	---	---	---	45.1	219	90.2	125			2680	
			2185	---	---	---	---	50.0	219	90.9	125			2716	
				2290	---	---	---	52.4	219	91.1	125			2732	
					2345	---	---	53.6	218	91.2	125			2739	
				2610	---	59.7	218	91.8	125	2772					
					3035	69.4	218	92.5	125	3035					
50	930	---	---	---	---	---	---	21.0	216	83.7	114	249	4.98	1486	
		1810	---	---	---	---	---	41.0	216	89.9	114			2897	
			2005	---	---	---	---	45.4	216	90.5	114			3210	
				2105	---	---	---	47.6	216	90.8	114			3367	
					2155	---	---	48.7	216	90.9	114			3446	
				2400	---	54.3	216	91.6	114	3838					
51	810	---	---	---	---	---	---	18.4	217	82.0	102	315	6.35	1292	
		1590	---	---	---	---	---	36.3	218	89.0	102			2194	
			1765	---	---	---	---	40.3	218	89.8	102			2224	
				1850	---	---	---	42.3	218	90.2	102			2237	
					1895	---	---	43.3	218	90.3	102			2243	
				2110	---	48.2	218	90.9	102	2271					
					2460	56.2	218	91.8	102	2460					

Nota (\*) - VENTILAZIONE SOLO L.O. / FAN ONLY SIDE COMMUTATOR

Nota (°) - Regolazione di campo / Field weakening



Potenza eccitazione Excitation power	(w)	1000	Tipo Size MGL 160 S Ventilazione Ventilation IC 06
Cost. tempo eccitaz. Field time constant	(ms)	230	
Massa del motore Mass of the motor	(Kg)	238	
Momento d'inerzia rotore Rotor inertia moment	(Kgm2)	0.23	

Avv.	Velocità nominale n/min a tensione nominale di armatura Rated speed (rev/min) at rated voltage							Potenza Power kW	Coppia vel.nomin. Torque at rated speed Nm	Rendimento Efficiency %	Circuito di armatura Armature circuit			Max giri Max. speed (°)			
	220	400	440	460	470	520	600				Corrente Current Amp	Res. 115°C mOhm	Ind. mH				
52	750	1485	---	---	---	---	---	17.1	218	81.0	96.0	360	7.18	1198			
			---	---	---	---	---	---	34.0	219	88.5			96.0	2374		
			---	---	---	---	---	---	37.7	219	89.3			96.0	2635		
			---	---	---	---	---	---	39.6	219	89.7			96.0	2766		
			---	---	---	---	---	---	40.5	219	89.8			96.0	2831		
			---	---	---	---	---	---	45.2	219	90.5			96.0	3158		
			---	---	---	---	---	---	1975	---	45.2			219	90.5	96.0	3158
			---	---	---	---	---	---	2300	52.6	218			91.3	96.0	96.0	3680
53	660	1320	---	---	---	---	---	15.2	220	79.4	87.0	443	8.83	1056			
			---	---	---	---	---	---	30.4	220	87.4			87.0	1839		
			---	---	---	---	---	---	33.8	220	88.3			87.0	1865		
			---	---	---	---	---	---	35.5	219	88.7			87.0	1876		
			---	---	---	---	---	---	36.4	220	89.0			87.0	1882		
			---	---	---	---	---	---	1580	---	36.4			220	89.0	87.0	1882
			---	---	---	---	---	---	1765	---	40.6			220	89.7	87.0	1905
			---	---	---	---	---	---	---	---	40.6			220	89.7	87.0	1905
54	620	1250	---	---	---	---	---	14.2	219	78.7	82.0	493	9.74	994			
			---	---	---	---	---	---	28.5	218	86.9			82.0	2002		
			---	---	---	---	---	---	31.7	218	87.9			82.0	2226		
			---	---	---	---	---	---	33.3	218	88.3			82.0	2338		
			---	---	---	---	---	---	1495	---	34.1			218	88.5	82.0	2394
			---	---	---	---	---	---	---	---	34.1			218	88.5	82.0	2394
55	525	1080	---	---	---	---	---	12.1	220	76.4	72.0	637	12.7	843			
			---	---	---	---	---	---	24.7	218	85.8			72.0	1725		
			---	---	---	---	---	---	27.5	219	86.8			72.0	1921		
			---	---	---	---	---	---	28.9	219	87.3			72.0	2019		
			---	---	---	---	---	---	1290	---	29.6			219	87.5	72.0	2068
			---	---	---	---	---	---	1445	---	33.1			219	88.4	72.0	2313
			---	---	---	---	---	---	---	---	33.1			219	88.4	72.0	2313
56	450	940	---	---	---	---	---	10.6	225	75.3	64.0	814	16.0	722			
			---	---	---	---	---	---	21.8	222	85.2			64.0	1506		
			---	---	---	---	---	---	24.2	220	85.9			64.0	1680		
			---	---	---	---	---	---	25.5	220	86.6			64.0	1768		
			---	---	---	---	---	---	1105	---	26.1			221	86.8	64.0	1811
			---	---	---	---	---	---	1130	---	29.3			220	88.0	64.0	2029
			---	---	---	---	---	---	1270	---	29.3			220	88.0	64.0	2029
			---	---	---	---	---	---	1485	34.2	220			89.1	64.0	64.0	2377
57	395	835	---	---	---	---	---	9.00	218	71.1	57.5	995	20.0	630			
			---	---	---	---	---	---	19.1	218	83.0			57.5	1336		
			---	---	---	---	---	---	21.3	218	84.2			57.5	1492		
			---	---	---	---	---	---	980	---	22.4			218	84.7	57.5	1571
			---	---	---	---	---	---	1005	---	23.0			219	85.1	57.5	1610
			---	---	---	---	---	---	1130	---	25.8			218	86.3	57.5	1806
			---	---	---	---	---	---	---	---	25.8			218	86.3	57.5	1806
			---	---	---	---	---	---	---	---	25.8			218	86.3	57.5	1806
58	345	745	---	---	---	---	---	7.84	217	68.5	52.0	1220	24.1	551			
			---	---	---	---	---	---	17.0	218	81.7			52.0	1192		
			---	---	---	---	---	---	19.00	217	83.0			52.0	1335		
			---	---	---	---	---	---	880	---	20.0			217	83.6	52.0	1406
			---	---	---	---	---	---	900	---	20.5			218	83.9	52.0	1442
			---	---	---	---	---	---	1015	---	23.0			216	85.1	52.0	1620
			---	---	---	---	---	---	---	---	23.0			216	85.1	52.0	1620
			---	---	---	---	---	---	---	---	23.0			216	85.1	52.0	1620

Nota (\*) - VENTILAZIONE SOLO L.O. / FAN ONLY SIDE COMMUTATOR

Nota (°) - Regolazione di campo / Field weakening



Potenza eccitazione Excitation power (w) 1000	Tipo
Cost. tempo eccitaz. Field time constant (ms) 230	Size MGL 160 S
Massa del motore Mass of the motor (Kg) 238	Ventilazione Ventilation IC 06
Momento d'inerzia rotore Rotor inertia moment (Kgm2) 0.23	

Avv.	Velocità nominale n/min a tensione nominale di armatura Rated speed (rev/min) at rated voltage							Potenza Power kW	Coppia vel. nomin. Torque at rated speed Nm	Rendimento Efficiency %	Circuito di armatura Armature circuit			Max giri Max. speed (°)	
	220	400	440	460	470	520	600				Corrente Current Amp	Res. 115°C mOhm	Ind. mH		
59	305	---	---	---	---	---	---	7.16	224	66.4	49.0	1390	28.8	489	
		675	---	---	---	---	---	15.8	224	80.6	49.0				1077
		755	---	---	---	---	---	17.7	224	82.1	49.0				1208
		795	---	---	---	---	---	18.6	223	82.5	49.0				1273
		815	---	---	---	---	---	19.1	224	82.9	49.0				1306
		920	---	---	---	---	---	21.5	223	84.4	49.0				1469
		1080	---	---	---	---	---	25.3	224	86.1	49.0				1731
60	274	---	---	---	---	---	---	6.45	225	64.4	45.5	1600	33.0	438	
		615	---	---	---	---	---	14.4	224	79.1	45.5				981
		690	---	---	---	---	---	16.2	224	80.9	45.5				1101
		725	---	---	---	---	---	17.1	225	81.7	45.5				1162
		745	---	---	---	---	---	17.5	224	81.8	45.5				1192
		840	---	---	---	---	---	19.8	225	83.7	45.5				1343
61	555	---	---	---	---	---	---	12.9	222	77.7	41.5	1910	39.3	892	
		625	---	---	---	---	---	14.5	222	79.4	41.5				1004
		660	---	---	---	---	---	15.3	221	80.1	41.5				1060
		680	---	---	---	---	---	15.7	221	80.5	41.5				1088
		765	---	---	---	---	---	17.8	222	82.5	41.5				1228
		905	---	---	---	---	---	21.0	222	84.3	41.5				1452
		---	---	---	---	---	---	---	---	---	---				---
62	510	---	---	---	---	---	---	11.6	217	76.3	38.0	2250	45.7	816	
		575	---	---	---	---	---	13.0	216	77.8	38.0				921
		610	---	---	---	---	---	13.8	216	78.9	38.0				973
		625	---	---	---	---	---	14.2	217	79.5	38.0				999
		705	---	---	---	---	---	16.0	217	81.0	38.0				1130
		835	---	---	---	---	---	19.0	217	83.3	38.0				1339
		---	---	---	---	---	---	---	---	---	---				---

Nota (\*) - VENTILAZIONE SOLO L.O. / FAN ONLY SIDE COMMUTATOR

Nota (°) - Regolazione di campo / Field weakening



Potenza eccitazione Excitation power (w) 1100				
Cost. tempo eccitaz. Field time constant (ms) 259				
Massa del motore Mass of the motor (Kg) 264				
Momento d'inerzia rotore Rotor inertia moment (Kgm2) 0.28				
	Tipo Size MGL 160 M			
	Ventilazione Ventilation IC 06			

Avv.	Velocità nominale n/min a tensione nominale di armatura Rated speed (rev/min) at rated voltage							Potenza Power kW	Coppia vel.nomin. Torque at rated speed Nm	Rendimento Efficiency %	Circuito di armatura Armature circuit			Max giri Max. speed (°)	
	220	400	440	460	470	520	600				Corrente Current Amp	Res. 115°C mOhm	Ind. mH		
45	1580	---	---	---	---	---	---	41.6	251	89.2	212	74.6	1.60	2531	
		2990	---	---	---	---	---	78.7	251	92.8	212			4405	*
			3305	---	---	---	---	87.0	251	93.3	212			4467	*
				3460	---	---	---	91.1	251	93.4	212			4495	*
					3540	---	---	91.9	248	93.6	209			4500	*
						3930	---	94.2	229	93.9	193			4500	*
46	1290	---	---	---	---	---	---	35.5	263	87.7	184	107	2.27	2068	
		2465	---	---	---	---	---	67.8	263	92.1	184			3540	
			2725	---	---	---	---	75.0	263	92.6	184			3589	*
				2860	---	---	---	78.6	262	92.9	184			3611	*
					2925	---	---	80.4	263	93.0	184			3621	*
						3250	---	89.3	262	93.3	184			3667	*
							3770	104	263	94.2	184			3771	*
47	1090	---	---	---	---	---	---	30.4	266	86.4	160	146	3.09	1741	
		2095	---	---	---	---	---	58.5	267	91.4	160			2993	
			2320	---	---	---	---	64.7	266	91.9	160			3035	
				2430	---	---	---	67.9	267	92.3	160			3053	
					2485	---	---	69.4	267	92.3	160			3062	
48	935	---	---	---	---	---	---	26.4	270	85.1	141	188	4.01	1498	
		1815	---	---	---	---	---	51.1	269	90.6	141			2600	
			2015	---	---	---	---	56.7	269	91.4	141			2637	
				2110	---	---	---	59.4	269	91.6	141			2653	
					2160	---	---	60.8	269	91.7	141			2660	
						2405	---	67.7	269	92.3	141			2694	
49	815	---	---	---	---	---	---	22.9	268	83.3	125	242	5.19	1306	
		1600	---	---	---	---	---	44.9	268	89.8	125			2313	
			1775	---	---	---	---	49.8	268	90.5	125			2346	
				1860	---	---	---	52.2	268	90.8	125			2361	
					1905	---	---	53.4	268	90.9	125			2368	
						2120	---	59.6	269	91.7	125			2398	
							2470	69.3	268	92.4	125			2470	
50	745	---	---	---	---	---	---	20.7	265	82.5	114	280	6.05	1193	
		1465	---	---	---	---	---	40.8	266	89.5	114			2348	
			1630	---	---	---	---	45.2	265	90.1	114			2605	
				1710	---	---	---	47.5	265	90.6	114			2733	
					1750	---	---	48.6	265	90.7	114			2797	
						1950	---	54.1	265	91.3	114			3118	
51	645	---	---	---	---	---	---	18.1	268	80.7	102	353	7.71	1035	
		1285	---	---	---	---	---	36.1	268	88.5	102			1892	
			1430	---	---	---	---	40.1	268	89.3	102			1920	
				1500	---	---	---	42.1	268	89.7	102			1933	
					1535	---	---	43.1	268	89.9	102			1939	
						1715	---	48.0	267	90.5	102			1964	
							2000	56.0	267	91.5	102			2000	

Nota (\*) - VENTILAZIONE SOLO L.O. / FAN ONLY SIDE COMMUTATOR

Nota (°) - Regolazione di campo / Field weakening



Potenza eccitazione Excitation power (w) 1100				
Cost. tempo eccitaz. Field time constant (ms) 259				
Massa del motore Mass of the motor (Kg) 264				
Momento d'inerzia rotore Rotor inertia moment (Kgm2) 0.28				
	Tipo Size MGL 160 M			
	Ventilazione Ventilation IC 06			

Avv.	Velocità nominale n/min a tensione nominale di armatura Rated speed (rev/min) at rated voltage							Potenza Power kW	Coppia vel.nomin. Torque at rated speed Nm	Rendimento Efficiency %	Circuito di armatura Armature circuit			Max giri Max. speed (°)
	220	400	440	460	470	520	600				Corrente Current Amp	Res. 115°C mOhm	Ind. mH	
52	600	---	---	---	---	---	---	16.8	267	79.5	96.0	404	8.72	957
		1200	---	---	---	---	---	33.7	268	87.8	96.0			1919
		---	1335	---	---	---	---	37.4	268	88.5	96.0			2133
		---	---	1400	---	---	---	39.3	268	89.0	96.0			2240
		---	---	---	1435	---	---	40.3	268	89.3	96.0			2294
		---	---	---	---	1600	---	45.0	269	90.1	96.0			2561
		---	---	---	---	---	1870	52.5	268	91.1	96.0			2989
		---	---	---	---	---	---	---	---	---	---			---
53	525	---	---	---	---	---	---	14.9	271	77.8	87.0	497	10.70	841
		1070	---	---	---	---	---	30.2	270	86.8	87.0			1586
		---	1190	---	---	---	---	33.6	270	87.8	87.0			1610
		---	---	1250	---	---	---	35.3	270	88.2	87.0			1620
		---	---	---	1280	---	---	36.1	269	88.3	87.0			1625
		---	---	---	---	1430	---	40.4	270	89.3	87.0			1647
54	495	---	---	---	---	---	---	13.8	266	76.5	82.0	552	11.80	791
		1010	---	---	---	---	---	28.3	268	86.3	82.0			1616
		---	1125	---	---	---	---	31.5	267	87.3	82.0			1799
		---	---	1180	---	---	---	33.1	268	87.8	82.0			1891
		---	---	---	1210	---	---	33.9	268	88.0	82.0			1936
55	415	---	---	---	---	---	---	11.7	269	73.9	72.0	714	15.4	667
		870	---	---	---	---	---	24.4	268	84.7	72.0			1389
		---	970	---	---	---	---	27.2	268	85.9	72.0			1549
		---	---	1020	---	---	---	28.6	268	86.4	72.0			1630
		---	---	---	1045	---	---	29.3	268	86.6	72.0			1670
		---	---	---	---	1170	---	32.8	268	87.6	72.0			1870
		---	---	---	---	---	---	---	---	---	---			---
56	355	---	---	---	---	---	---	9.98	269	70.9	64.0	913	19.4	568
		755	---	---	---	---	---	21.2	268	82.8	64.0			1210
		---	845	---	---	---	---	23.8	269	84.5	64.0			1352
		---	---	890	---	---	---	25.0	268	84.9	64.0			1424
		---	---	---	910	---	---	25.6	269	85.1	64.0			1459
		---	---	---	---	1025	---	28.8	268	86.5	64.0			1637
		---	---	---	---	---	1200	33.8	269	88.0	64.0			1922
		---	---	---	---	---	---	---	---	---	---			---
57	310	---	---	---	---	---	---	8.65	267	68.4	57.5	1110	24.3	493
		670	---	---	---	---	---	18.8	268	81.7	57.5			1071
		---	750	---	---	---	---	21.0	267	83.0	57.5			1199
		---	---	790	---	---	---	22.1	267	83.6	57.5			1263
		---	---	---	810	---	---	22.7	268	84.0	57.5			1295
		---	---	---	---	910	---	25.5	268	85.3	57.5			1455
		---	---	---	---	---	---	---	---	---	---			---
58	268	---	---	---	---	---	---	7.48	267	65.4	52.0	1360	29.3	429
		595	---	---	---	---	---	16.6	266	79.8	52.0			953
		---	670	---	---	---	---	18.70	267	81.7	52.0			1070
		---	---	705	---	---	---	19.7	267	82.4	52.0			1128
		---	---	---	725	---	---	20.2	266	82.7	52.0			1157
		---	---	---	---	815	---	22.7	266	83.9	52.0			1303
		---	---	---	---	---	---	---	---	---	---			---

Nota (\*) - VENTILAZIONE SOLO L.O. / FAN ONLY SIDE COMMUTATOR

Nota (°) - Regolazione di campo / Field weakening



Potenza eccitazione Excitation power (w)	1100	Tipo	
Cost. tempo eccitaz. Field time constant (ms)	259	Size	MGL 160 M
Massa del motore Mass of the motor (Kg)	264	Ventilazione Ventilation	IC 06
Momento d'inerzia rotore Rotor inertia moment (Kgm2)	0.28		

Avv.	Velocità nominale n/min a tensione nominale di armatura Rated speed (rev/min) at rated voltage							Potenza Power kW	Coppia vel. nomin. Torque at rated speed Nm	Rendimento Efficiency %	Circuito di armatura Armature circuit			Max giri Max. speed (°)
	220	400	440	460	470	520	600				Corrente Current Amp	Res. 115°C mOhm	Ind. mH	
59		535	---	---	---	---	---	15.4	275	78.6	49.0	1560	35.0	859
			605	---	---	---	---	17.3	273	80.2	49.0			966
				635	---	---	---	18.3	275	81.2	49.0			1020
					655	---	---	18.8	274	81.6	49.0			1046
						740	---	21.2	274	83.2	49.0			1180
							870	25.0	274	85.0	49.0			1394
60		490	---	---	---	---	---	14.1	275	77.5	45.5	1790	40.0	781
			550	---	---	---	---	15.9	276	79.4	45.5			880
				580	---	---	---	16.8	277	80.3	45.5			929
					595	---	---	17.2	276	80.4	45.5			954
						675	---	19.4	275	82.0	45.5			1077
61		440	---	---	---	---	---	12.6	274	75.9	41.5	2140	47.7	708
			500	---	---	---	---	14.2	271	77.8	41.5			799
				530	---	---	---	15.0	270	78.6	41.5			845
					545	---	---	15.4	270	79.0	41.5			868
						615	---	17.4	270	80.6	41.5			983
							730	20.7	271	83.1	41.5			1166
62		405	---	---	---	---	---	11.2	264	73.7	38.0	2530	55.5	646
			455	---	---	---	---	12.7	267	76.0	38.0			731
				485	---	---	---	13.5	266	77.2	38.0			774
					495	---	---	13.8	266	77.3	38.0			795
						565	---	15.7	265	79.5	38.0			902
							670	18.7	267	82.0	38.0			1073

Nota (\*) - VENTILAZIONE SOLO L.O. / FAN ONLY SIDE COMMUTATOR

Nota (°) - Regolazione di campo / Field weakening



Potenza eccitazione Excitation power	(w)	1200	Tipo	
Cost. tempo eccitaz. Field time constant	(ms)	289	Size	MGL 160 L
Massa del motore Mass of the motor	(Kg)	302	Ventilazione Ventilation	IC 06
Momento d'inerzia rotore Rotor inertia moment	(Kgm2)	0.34		

Avv.	Velocità nominale n/min a tensione nominale di armatura Rated speed (rev/min) at rated voltage							Potenza Power kW	Coppia vel.nomin. Torque at rated speed Nm	Rendimento Efficiency %	Circuito di armatura Armature circuit			Max giri Max. speed (°)		
	220	400	440	460	470	520	600				Corrente Current Amp	Res. 115°C mOhm	Ind. mH			
45	1275	---	---	---	---	---	---	41.4	310	88.8	212	84.9	1.95	2040	*	
		2425	---	---	---	---	---	78.6	310	92.7	212					3761
		2680	---	---	---	---	---	86.9	310	93.2	212					3818
			2805	---	---	---	---	91.0	310	93.3	212					3843
		2870	---	---	---	---	---	93.1	310	93.4	212					3854
			3190	---	---	---	---	103	308	93.4	212					3907
		46	1040	---	---	---	---	---	---	35.2	323					87.0
1995	---			---	---	---	---	67.6	324	91.8	184	3023				
2210	---			---	---	---	---	74.8	323	92.4	184	3067				
	2315			---	---	---	---	78.4	323	92.6	184	3087				
2365	---			---	---	---	---	80.2	324	92.7	184	3096				
	2635			---	---	---	---	89.2	323	93.2	184	3138				
3060	---			---	---	---	---	104	325	94.2	184	3191				
47	870	---	---	---	---	---	---	30.0	329	85.2	160	166	3.78	1395	*	
		1690	---	---	---	---	---	58.2	329	90.9	160					2555
		1875	---	---	---	---	---	64.5	329	91.6	160					2593
			1965	---	---	---	---	67.6	329	91.8	160					2610
		2010	---	---	---	---	69.2	329	92.0	160	2618					
48	750	---	---	---	---	---	---	25.9	330	83.5	141	214	4.90	1198	*	
		1465	---	---	---	---	---	50.8	331	90.1	141					2219
		1625	---	---	---	---	---	56.4	331	90.9	141					2253
			1705	---	---	---	---	59.1	331	91.1	141					2267
		1745	---	---	---	---	---	60.5	331	91.3	141					2274
			1945	---	---	---	---	67.4	331	91.9	141					2305
		49	650	---	---	---	---	---	---	22.5	331					81.8
1290	---			---	---	---	---	44.5	329	89.0	125	1973				
1430	---			---	---	---	---	49.4	330	89.8	125	2004				
	1500			---	---	---	---	51.9	330	90.3	125	2017				
1535	---			---	---	---	---	53.1	330	90.4	125	2024				
	1715			---	---	---	---	59.2	330	91.1	125	2052				
1995	---			---	---	---	---	69.1	331	92.1	125	2087				
50	595	---	---	---	---	---	---	20.3	326	80.9	114	317	7.39	950	*	
		1180	---	---	---	---	---	40.4	327	88.6	114					1891
		1310	---	---	---	---	---	44.9	327	89.5	114					2100
			1380	---	---	---	---	47.1	326	89.8	114					2204
		1410	---	---	---	---	---	48.2	326	90.0	114					2256
			1575	---	---	---	---	53.8	326	90.8	114					2518
		51	515	---	---	---	---	---	---	17.7	328					78.9
1035	---			---	---	---	---	35.7	329	87.5	102	1614				
1150	---			---	---	---	---	39.7	330	88.5	102	1640				
	1210			---	---	---	---	41.7	329	88.9	102	1651				
1240	---			---	---	---	---	42.7	329	89.1	102	1656				
	1385			---	---	---	---	47.7	329	89.9	102	1680				
1615	---			---	---	---	---	55.7	329	91.0	102	1710				

Nota (\*) - VENTILAZIONE SOLO L.O. / FAN ONLY SIDE COMMUTATOR

Nota (°) - Regolazione di campo / Field weakening





Potenza eccitazione Excitation power	(w)	1200	Tipo Size MGL 160 L Ventilazione Ventilation IC 06
Cost. tempo eccitaz. Field time constant	(ms)	289	
Massa del motore Mass of the motor	(Kg)	302	
Momento d'inerzia rotore Rotor inertia moment	(Kgm2)	0.34	

Avv.	Velocità nominale n/min a tensione nominale di armatura Rated speed (rev/min) at rated voltage							Potenza Power kW	Coppia vel.nomin. Torque at rated speed Nm	Rendimento Efficiency %	Circuito di armatura Armature circuit			Max giri Max. speed (°)	
	220	400	440	460	470	520	600				Corrente Current Amp	Res. 115°C mOhm	Ind. mH		
52	475	---	---	---	---	---	---	16.4	330	77.7	96.0	459	10.6	757	
		965	---	---	---	---	---	33.3	330	86.7	96.0			1541	
		1070	---	---	---	---	---	37.1	331	87.8	96.0			1715	
		---	---	---	---	---	---	39.0	331	88.3	96.0			1802	
		---	---	---	1125	---	---	39.9	330	88.4	96.0			1846	
		---	---	---	---	1155	---	44.6	330	89.3	96.0			2064	
		---	---	---	---	---	1290	---	52.1	330	90.5			96.0	2412
		---	---	---	---	---	---	1510	---	---	---			---	---
53	415	---	---	---	---	---	---	14.4	331	75.2	87.0	564	13.1	662	
		855	---	---	---	---	---	29.8	333	85.6	87.0			1351	
		---	955	---	---	---	---	33.2	332	86.7	87.0			1374	
		---	---	---	---	---	---	34.9	332	87.2	87.0			1384	
		---	---	---	1005	---	---	35.7	333	87.3	87.0			1388	
		---	---	---	---	1025	---	40.0	332	88.4	87.0			1408	
54	390	---	---	---	---	---	---	13.4	328	74.3	82.0	626	14.4	622	
		810	---	---	---	---	---	27.9	329	85.1	82.0			1294	
		---	900	---	---	---	---	31.1	330	86.2	82.0			1443	
		---	---	---	950	---	---	32.7	329	86.7	82.0			1518	
		---	---	---	---	970	---	33.5	330	86.9	82.0			1555	
55	325	---	---	---	---	---	---	11.3	332	71.3	72.0	810	18.8	521	
		695	---	---	---	---	---	24.0	330	83.3	72.0			1109	
		---	775	---	---	---	---	26.8	330	84.6	72.0			1240	
		---	---	---	815	---	---	28.2	330	85.1	72.0			1305	
		---	---	---	---	835	---	28.9	331	85.4	72.0			1338	
		---	---	---	---	---	940	---	32.5	330	86.8			72.0	1501
		---	---	---	---	---	---	---	---	---	---			---	---
56	275	---	---	---	---	---	---	9.52	331	67.6	64.0	1040	23.7	440	
		600	---	---	---	---	---	20.8	331	81.3	64.0			963	
		---	675	---	---	---	---	23.3	330	82.7	64.0			1079	
		---	---	---	710	---	---	24.6	331	83.6	64.0			1137	
		---	---	---	---	730	---	25.2	330	83.8	64.0			1166	
		---	---	---	---	---	820	---	28.3	330	85.0			64.0	1311
		---	---	---	---	---	---	965	33.4	331	87.0			64.0	1543
		---	---	---	---	---	---	---	---	---	---			---	---
57	237	---	---	---	---	---	---	8.19	330	64.7	57.5	1260	29.7	379	
		530	---	---	---	---	---	18.4	332	80.0	57.5			850	
		---	595	---	---	---	---	20.6	331	81.4	57.5			954	
		---	---	---	630	---	---	21.7	329	82.0	57.5			1007	
		---	---	---	---	645	---	22.3	330	82.5	57.5			1033	
		---	---	---	---	---	725	---	25.1	331	83.9			57.5	1163
		---	---	---	---	---	---	---	---	---	---			---	---
58	470	---	---	---	---	---	---	16.2	329	77.9	52.0	1550	35.8	754	
		530	---	---	---	---	---	18.2	328	79.5	52.0			849	
		---	---	---	560	---	---	19.3	329	80.7	52.0			897	
		---	---	---	---	575	---	19.8	329	81.0	52.0			920	
		---	---	---	---	---	650	---	22.3	328	82.5			52.0	1039
		---	---	---	---	---	---	---	---	---	---			---	---

Nota (\*) - VENTILAZIONE SOLO L.O. / FAN ONLY SIDE COMMUTATOR

Nota (°) - Regolazione di campo / Field weakening





Potenza eccitazione Excitation power (w)	1200	Tipo	
Cost. tempo eccitaz. Field time constant (ms)	289	Size	MGL 160 L
Massa del motore Mass of the motor (Kg)	302	Ventilazione Ventilation	IC 06
Momento d'inerzia rotore Rotor inertia moment (Kgm2)	0.34		

Avv.	Velocità nominale n/min a tensione nominale di armatura Rated speed (rev/min) at rated voltage							Potenza Power kW	Coppia vel. nomin. Torque at rated speed Nm	Rendimento Efficiency %	Circuito di armatura Armature circuit			Max giri Max. speed (°)
	220	400	440	460	470	520	600				Corrente Current Amp	Res. 115°C mOhm	Ind. mH	
59		425	---	---	---	---	---	15.0	337	76.5	49.0	1770	42.7	678
			480	---	---	---	---	16.9	336	78.4	49.0			765
				505	---	---	---	17.9	339	79.4	49.0			809
					520	---	---	18.3	336	79.5	49.0			830
						585	---	20.8	340	81.6	49.0			939
							695	24.6	338	83.7	49.0			1113
60		385	---	---	---	---	---	13.7	340	75.3	45.5	2030	48.9	614
			435	---	---	---	---	15.4	338	76.9	45.5			695
				460	---	---	---	16.3	338	77.9	45.5			735
					470	---	---	16.8	341	78.6	45.5			755
						535	---	19.0	339	80.3	45.5			856
61		345	---	---	---	---	---	12.1	335	72.9	41.5	2430	58.2	554
			395	---	---	---	---	13.7	331	75.0	41.5			629
				415	---	---	---	14.5	334	76.0	41.5			666
					430	---	---	15.0	333	76.9	41.5			685
						485	---	17.0	335	78.8	41.5			778
							580	20.2	333	81.1	41.5			928
62		315	---	---	---	---	---	10.8	327	71.1	38.0	2870	67.7	504
			360	---	---	---	---	12.3	326	73.6	38.0			573
				380	---	---	---	13.0	327	74.4	38.0			608
					390	---	---	13.4	328	75.0	38.0			625
						445	---	15.3	328	77.4	38.0			713
							530	18.2	328	79.8	38.0			852

Nota (\*) - VENTILAZIONE SOLO L.O. / FAN ONLY SIDE COMMUTATOR

Nota (°) - Regolazione di campo / Field weakening



Potenza eccitazione Excitation power	(w)	1300	Tipo Size MGL 160 P Ventilazione Ventilation IC 06
Cost. tempo eccitaz. Field time constant	(ms)	310	
Massa del motore Mass of the motor	(Kg)	320	
Momento d'inerzia rotore Rotor inertia moment	(Kgm2)	0.37	

Avv.	Velocità nominale n/min a tensione nominale di armatura Rated speed (rev/min) at rated voltage							Potenza Power kW	Coppia vel.nomin. Torque at rated speed Nm	Rendimento Efficiency %	Circuito di armatura Armature circuit			Max giri Max. speed (°)	
	220	400	440	460	470	520	600				Corrente Current Amp	Res. 115°C mOhm	Ind. mH		
45	1140	---	---	---	---	---	---	41.2	345	88.3	212	91.1	2.16	1824	*
		2175	---	---	---	---	---	78.5	345	92.6	212			3457	
		2405	---	---	---	---	---	86.8	345	93.1	212			3511	
			2515	---	---	---	---	90.9	345	93.2	212			3534	
		2575	---	---	---	---	---	93.0	345	93.3	212			3545	
			2860	---	---	---	---	103	344	93.4	212			3595	
		46	925	---	---	---	---	---	---	34.9	360			86.2	
1790	---			---	---	---	---	67.4	360	91.6	184	2778			
1980	---			---	---	---	---	74.6	360	92.1	184	2821			
	2075			---	---	---	---	78.2	360	92.4	184	2840			
2125	---			---	---	---	---	80.0	360	92.5	184	2848			
	2360			---	---	---	---	89.0	360	93.0	184	2888			
2745	---			---	---	---	---	104	362	94.2	184	2938			
47	775	---	---	---	---	---	---	29.7	366	84.4	160	178	4.19	1243	*
		1515	---	---	---	---	---	58.0	366	90.6	160			2349	
		1680	---	---	---	---	---	64.3	366	91.3	160			2385	
			1760	---	---	---	---	67.4	366	91.6	160			2401	
		1800	---	---	---	---	69.0	366	91.8	160	2408				
48	665	---	---	---	---	---	---	25.7	369	82.8	141	229	5.43	1065	*
		1310	---	---	---	---	---	50.6	369	89.7	141			2039	
		1455	---	---	---	---	---	56.1	368	90.4	141			2071	
			1525	---	---	---	---	58.9	369	90.8	141			2085	
		1565	---	---	---	---	---	60.3	368	91.0	141			2092	
			1740	---	---	---	---	67.2	369	91.7	141			2121	
		49	575	---	---	---	---	---	---	22.2	369			80.7	
1150	---			---	---	---	---	44.3	368	88.6	125	1813			
1280	---			---	---	---	---	49.2	367	89.5	125	1842			
	1345			---	---	---	---	51.7	367	89.9	125	1855			
1375	---			---	---	---	---	52.9	367	90.0	125	1861			
	1535			---	---	---	---	59.0	367	90.8	125	1887			
1790	---			---	---	---	---	68.8	367	91.7	125	1921			
50	525	---	---	---	---	---	---	20.0	364	79.7	114	340	8.19	843	*
		1055	---	---	---	---	---	40.2	364	88.2	114			1689	
		1175	---	---	---	---	---	44.7	363	89.1	114			1878	
			1230	---	---	---	---	46.9	364	89.4	114			1972	
		1260	---	---	---	---	---	48.0	364	89.6	114			2019	
			1410	---	---	---	---	53.6	363	90.4	114			2254	
		51	455	---	---	---	---	---	---	17.4	365			77.5	
925	---			---	---	---	---	35.5	367	87.0	102	1478			
1030	---			---	---	---	---	39.5	366	88.0	102	1507			
	1080			---	---	---	---	41.5	367	88.4	102	1518			
1105	---			---	---	---	---	42.5	367	88.7	102	1523			
	1235			---	---	---	---	47.5	367	89.6	102	1545			
1445	---			---	---	---	---	55.5	367	90.7	102	1573			

Nota (\*) - VENTILAZIONE SOLO L.O. / FAN ONLY SIDE COMMUTATOR

Nota (°) - Regolazione di campo / Field weakening



Potenza eccitazione Excitation power	(w)	1300	Tipo Size MGL 160 P Ventilazione Ventilation IC 06
Cost. tempo eccitaz. Field time constant	(ms)	310	
Massa del motore Mass of the motor	(Kg)	320	
Momento d'inerzia rotore Rotor inertia moment	(Kgm2)	0.37	

Avv.	Velocità nominale n/min a tensione nominale di armatura Rated speed (rev/min) at rated voltage							Potenza Power kW	Coppia vel.nomin. Torque at rated speed Nm	Rendimento Efficiency %	Circuito di armatura Armature circuit			Max giri Max. speed (°)	
	220	400	440	460	470	520	600				Corrente Current Amp	Res. 115°C mOhm	Ind. mH		
52	420	---	---	---	---	---	---	16.1	366	76.2	96.0	492	11.8	669	
		860	---	---	---	---	---	33.1	368	86.2	96.0				1375
		955	---	---	---	---	---	36.8	368	87.1	96.0				1531
		1005	---	---	---	---	---	38.7	368	87.6	96.0				1610
		1030	---	---	---	---	---	39.7	368	88.0	96.0				1649
		1155	---	---	---	---	---	44.4	367	88.9	96.0				1845
		1350	---	---	---	---	---	51.9	367	90.1	96.0				2159
53	365	---	---	---	---	---	---	14.1	369	73.7	87.0	605	14.5	584	
		760	---	---	---	---	---	29.5	371	84.8	87.0				1220
		850	---	---	---	---	---	32.9	370	85.9	87.0				1262
		895	---	---	---	---	---	34.6	369	86.5	87.0				1271
		915	---	---	---	---	---	35.5	371	86.8	87.0				1276
		1025	---	---	---	---	---	39.8	371	88.0	87.0				1295
54	340	---	---	---	---	---	---	13.1	368	72.6	82.0	671	16.0	547	
		720	---	---	---	---	---	27.6	366	84.1	82.0				1152
		805	---	---	---	---	---	30.8	365	85.4	82.0				1287
		845	---	---	---	---	---	32.4	366	85.9	82.0				1354
		865	---	---	---	---	---	33.3	368	86.4	82.0				1387
55	286	---	---	---	---	---	---	11.0	367	69.4	72.0	868	20.9	457	
		615	---	---	---	---	---	23.7	368	82.3	72.0				986
		690	---	---	---	---	---	26.6	368	84.0	72.0				1104
		725	---	---	---	---	---	28.0	369	84.5	72.0				1163
		745	---	---	---	---	---	28.7	368	84.8	72.0				1192
		835	---	---	---	---	---	32.2	368	86.0	72.0				1339
56	240	---	---	---	---	---	---	9.23	367	65.6	64.0	1110	26.3	384	
		535	---	---	---	---	---	20.5	366	80.1	64.0				854
		600	---	---	---	---	---	23.1	368	82.0	64.0				959
		630	---	---	---	---	---	24.3	368	82.5	64.0				1011
		650	---	---	---	---	---	24.9	366	82.8	64.0				1037
		730	---	---	---	---	---	28.1	368	84.4	64.0				1168
		860	---	---	---	---	---	33.1	368	86.2	64.0				1377
57	470	---	---	---	---	---	---	18.1	368	78.7	57.5	1350	32.9	753	
		530	---	---	---	---	---	20.3	366	80.2	57.5				847
		560	---	---	---	---	---	21.5	367	81.3	57.5				894
		575	---	---	---	---	---	22.0	365	81.4	57.5				917
		645	---	---	---	---	---	24.9	369	83.3	57.5				1035
		---	---	---	---	---	---	---	---	---	---				---
58	415	---	---	---	---	---	---	15.9	366	76.4	52.0	1660	39.6	666	
		470	---	---	---	---	---	18.0	366	78.7	52.0				752
		495	---	---	---	---	---	19.0	367	79.4	52.0				795
		510	---	---	---	---	---	19.5	365	79.8	52.0				816
		575	---	---	---	---	---	22.1	367	81.7	52.0				923
		---	---	---	---	---	---	---	---	---	---				---

Nota (\*) - VENTILAZIONE SOLO L.O. / FAN ONLY SIDE COMMUTATOR

Nota (°) - Regolazione di campo / Field weakening



Potenza eccitazione Excitation power (w)	1300	Tipo	
Cost. tempo eccitaz. Field time constant (ms)	310	Size	MGL 160 P
Massa del motore Mass of the motor (Kg)	320	Ventilazione Ventilation	IC 06
Momento d'inerzia rotore Rotor inertia moment (Kgm2)	0.37		

Avv.	Velocità nominale n/min a tensione nominale di armatura Rated speed (rev/min) at rated voltage							Potenza Power kW	Coppia vel. nomin. Torque at rated speed Nm	Rendimento Efficiency %	Circuito di armatura Armature circuit			Max giri Max. speed (°)
	220	400	440	460	470	520	600				Corrente Current Amp	Res. 115°C mOhm	Ind. mH	
59		375	---	---	---	---	---	14.7	374	75.0	49.0	1890	47.3	598
			425	---	---	---	---	16.6	373	77.0	49.0			676
				445	---	---	---	17.6	378	78.1	49.0			716
					460	---	---	18.1	376	78.6	49.0			735
						520	---	20.5	377	80.5	49.0			833
							620	24.3	374	82.7	49.0			990
60		340	---	---	---	---	---	13.4	376	73.6	45.5	2170	54.2	541
			385	---	---	---	---	15.2	377	75.9	45.5			613
				405	---	---	---	16.1	380	76.9	45.5			650
					415	---	---	16.5	380	77.2	45.5			668
						475	---	18.8	378	79.5	45.5			758
61		305	---	---	---	---	---	11.8	369	71.1	41.5	2610	64.5	487
			345	---	---	---	---	13.5	374	73.9	41.5			554
				365	---	---	---	14.3	374	74.9	41.5			588
					380	---	---	14.7	369	75.4	41.5			604
						430	---	16.7	371	77.4	41.5			688
							515	20.0	371	80.3	41.5			823
62		276	---	---	---	---	---	10.5	363	69.1	38.0	3070	75.1	441
			315	---	---	---	---	12.0	364	71.8	38.0			504
				335	---	---	---	12.8	365	73.2	38.0			535
					345	---	---	13.1	363	73.3	38.0			551
						395	---	15.0	363	75.9	38.0			629
							470	18.0	366	78.9	38.0			755

Nota (\*) - VENTILAZIONE SOLO L.O. / FAN ONLY SIDE COMMUTATOR

Nota (°) - Regolazione di campo / Field weakening



Potenza eccitazione Excitation power	(w)	1400	Tipo Size	MGL	160 X
Cost. tempo eccitaz. Field time constant	(ms)	333	Ventilazione Ventilation		IC 06
Massa del motore Mass of the motor	(Kg)	350			
Momento d'inerzia rotore Rotor inertia moment	(Kgm2)	0.41			

Avv.	Velocità nominale n/min a tensione nominale di armatura Rated speed (rev/min) at rated voltage							Potenza Power kW	Coppia vel.nomin. Torque at rated speed Nm	Rendimento Efficiency %	Circuito di armatura Armature circuit			Max giri Max. speed (°)		
	220	400	440	460	470	520	600				Corrente Current Amp	Res. 115°C mOhm	Ind. mH			
45	1025	---	---	---	---	---	---	40.7	379	87.3	212	96.0	2.38	1632	*	
		1960	---	---	---	---	---	77.7	379	91.6	212					3094
			2165	---	---	---	---	86.0	379	92.2	212					4843
				2270	---	---	---	90.1	379	92.4	212					3163
					2320	---	---	92.1	379	92.4	212					3173
						2580	---	102	378	92.5	212					3218
46	830	---	---	---	---	---	---	34.3	395	84.7	184	138	3.38	1327	*	
		1610	---	---	---	---	---	66.4	394	90.2	184					2486
			1785	---	---	---	---	73.6	394	90.9	184					2525
				1870	---	---	---	77.1	394	91.1	184					2542
					1910	---	---	78.9	395	91.2	184					2549
						2130	---	87.8	394	91.8	184					2585
							2475	102	394	92.4	184					2630
47	695	---	---	---	---	---	---	29.2	401	83.0	160	187	4.61	1112	*	
		1365	---	---	---	---	---	57.1	400	89.2	160					2102
			1510	---	---	---	---	63.3	400	89.9	160					2135
				1585	---	---	---	66.4	400	90.2	160					2149
					1625	---	---	68.0	400	90.4	160					2155
48	610	---	---	---	---	---	---	25.2	395	81.2	141	237	5.97	953	*	
		1210	---	---	---	---	---	49.8	393	88.3	141					1825
			1345	---	---	---	---	55.3	393	89.1	141					1854
				1410	---	---	---	58.0	393	89.4	141					1866
					1445	---	---	59.4	393	89.6	141					1872
						1610	---	66.2	393	90.3	141					1898
49	515	---	---	---	---	---	---	21.8	404	79.3	125	310	7.72	826	*	
		1035	---	---	---	---	---	43.8	404	87.6	125					1623
			1150	---	---	---	---	48.7	404	88.5	125					1649
				1205	---	---	---	51.1	405	88.9	125					1660
					1235	---	---	52.3	404	89.0	125					1666
						1380	---	58.4	404	89.8	125					1689
							1610	68.2	405	90.9	125					1719
50	470	---	---	---	---	---	---	19.7	400	78.5	114	357	9.01	754	*	
		950	---	---	---	---	---	39.8	400	87.3	114					1512
			1055	---	---	---	---	44.2	400	88.1	114					1681
				1110	---	---	---	46.5	400	88.7	114					1765
					1135	---	---	47.6	401	88.8	114					1807
						1270	---	53.2	400	89.7	114					2017
51	405	---	---	---	---	---	---	17.2	406	76.6	102	449	11.4	651	*	
		830	---	---	---	---	---	35.1	404	86.0	102					1323
			925	---	---	---	---	39.1	404	87.1	102					1349
				970	---	---	---	41.1	405	87.6	102					1359
					995	---	---	42.1	404	87.8	102					1363
						1115	---	47.1	403	88.8	102					1383
							1300	55.1	405	90.0	102					1408

Nota (\*) - VENTILAZIONE SOLO L.O. / FAN ONLY SIDE COMMUTATOR

Nota (°) - Regolazione di campo / Field weakening



Potenza eccitazione Excitation power	(w)	1400	Tipo Size MGL 160 X Ventilazione Ventilation IC 06
Cost. tempo eccitaz. Field time constant	(ms)	333	
Massa del motore Mass of the motor	(Kg)	350	
Momento d'inerzia rotore Rotor inertia moment	(Kgm2)	0.41	

Avv.	Velocità nominale n/min a tensione nominale di armatura Rated speed (rev/min) at rated voltage							Potenza Power kW	Coppia vel.nomin. Torque at rated speed Nm	Rendimento Efficiency %	Circuito di armatura Armature circuit			Max giri Max. speed (°)					
	220	400	440	460	470	520	600				Corrente Current Amp	Res. 115°C mOhm	Ind. mH						
52	370	---	---	---	---	---	---	15.7	405	74.3	96.0	516	13.0	599					
		770	---	---	---	---	---	32.4	402	84.4	96.0								
		860	---	---	---	---	---	36.1	401	85.5	96.0								
			905	---	---	---	---	38.0	401	86.1	96.0								
		925	---	---	---	---	---	38.9	402	86.2	96.0								
			1035	---	---	---	---	43.6	402	87.3	96.0								
		1215		---	---	---	---	51.0	401	88.5	96.0								
			53	325	---	---	---	---	---	13.8	406				72.1	87.0	637	16.0	523
685	---	---			---	---	---	29.2	407	83.9	87.0								
765	---	---			---	---	---	32.6	407	85.2	87.0								
	805	---			---	---	---	34.3	407	85.7	87.0								
825	---	---			---	---	---	35.1	406	85.8	87.0								
	925	---			---	---	---	39.4	407	87.1	87.0								
54		305			---	---	---	---	---	12.8	401	71.0	82.0	702	17.6	490			
	645				---	---	---	---	---	27.2	403	82.9	82.0						
	720		---	---	---	---	---	30.4	403	84.3	82.0								
			760	---	---	---	---	32.0	402	84.8	82.0								
	780		---	---	---	---	---	32.8	402	85.1	82.0								
			55	255	---	---	---	---	---	10.8	404	68.2	72.0				907	23.0	409
	550				---	---	---	---	---	23.5	408	81.6	72.0						
	620		---		---	---	---	---	26.4	407	83.3	72.0							
650		---	---		---	---	27.8	408	83.9	72.0									
670	---	---	---		---	---	28.5	406	84.2	72.0									
	750	---	---		---	---	32.0	407	85.5	72.0									
56		475	---		---	---	---	---	20.2	406	78.9	64.0	1166	28.9	764				
	535		---		---	---	---	---	22.7	405	80.6	64.0							
	565		---	---	---	---	---	24.0	406	81.5	64.0								
			580	---	---	---	---	24.6	405	81.8	64.0								
	655		---	---	---	---	---	27.7	404	83.2	64.0								
			770	---	---	---	---	32.7	406	85.2	64.0								
	57			420	---	---	---	---	---	17.9	407	77.8				57.5	1412	36.2	674
			475		---	---	---	---	---	20.2	406	79.8				57.5			
500		---	---		---	---	---	21.3	407	80.5	57.5								
		515	---		---	---	---	21.9	406	81.0	57.5								
580		---	---		---	---	---	24.7	407	82.6	57.5								
		58	370		---	---	---	---	---	15.7	405	75.5	52.0	1727	43.6	596			
420					---	---	---	---	---	17.8	405	77.8	52.0						
445					---	---	---	---	---	18.8	403	78.6	52.0						
	455			---	---	---	---	19.3	405	79.0	52.0								
515	---			---	---	---	---	21.9	406	81.0	52.0								

Nota (\*) - VENTILAZIONE SOLO L.O. / FAN ONLY SIDE COMMUTATOR

Nota (°) - Regolazione di campo / Field weakening



Potenza eccitazione Excitation power (w)	1400	Tipo	
Cost. tempo eccitaz. Field time constant (ms)	333	Size	MGL 160 X
Massa del motore Mass of the motor (Kg)	350	Ventilazione Ventilation	IC 06
Momento d'inerzia rotore Rotor inertia moment (Kgm2)	0.41		

Avv.	Velocità nominale n/min a tensione nominale di armatura Rated speed (rev/min) at rated voltage							Potenza Power kW	Coppia vel.nomin. Torque at rated speed Nm	Rendimento Efficiency %	Circuito di armatura Armature circuit			Max giri Max. speed (°)
	220	400	440	460	470	520	600				Corrente Current Amp	Res. 115°C mOhm	Ind. mH	
59		335	---	---	---	---	---	14.5	413	74.0	49.0	1978	52.0	535
			375	---	---	---	---	16.4	418	76.1	49.0			605
				400	---	---	---	17.4	415	77.2	49.0			68
					410	---	---	17.9	417	77.7	49.0			658
						465	---	20.3	417	79.7	49.0			746
							555	24.1	415	82.0	49.0			886
60		295	---	---	---	---	---	13.0	421	71.4	45.5	2373	59.6	484
			335	---	---	---	---	14.8	422	73.9	45.5			549
				355	---	---	---	15.7	422	75.0	45.5			582
					370	---	---	16.1	416	75.3	45.5			598
						420	---	18.3	416	77.3	45.5			678
61		265	---	---	---	---	---	11.4	411	68.7	41.5	2827	71.0	436
			305	---	---	---	---	13.1	410	71.7	41.5			496
				325	---	---	---	13.9	408	72.8	41.5			526
					330	---	---	14.3	414	73.3	41.5			541
						380	---	16.3	410	75.5	41.5			616
							455	19.6	411	78.7	41.5			737
62		240	---	---	---	---	---	10.1	402	66.4	38.0	3334	82.6	395
			275	---	---	---	---	11.6	403	69.4	38.0			451
				295	---	---	---	12.4	401	70.9	38.0			479
					300	---	---	12.7	404	71.1	38.0			493
						345	---	14.6	404	73.9	38.0			563
							415	17.6	405	77.2	38.0			676

Nota (\*) - VENTILAZIONE SOLO L.O. / FAN ONLY SIDE COMMUTATOR

Nota (°) - Regolazione di campo / Field weakening







Potenza eccitazione Excitation power	(w)	1500	Tipo Size MGL 160 X2 Ventilazione Ventilation IC 06
Cost. tempo eccitaz. Field time constant	(ms)	357	
Massa del motore Mass of the motor	(Kg)	403	
Momento d'inerzia rotore Rotor inertia moment	(Kgm2)	0.47	

Avv.	Velocità nominale n/min a tensione nominale di armatura Rated speed (rev/min) at rated voltage							Potenza Power kW	Coppia vel.nomin. Torque at rated speed Nm	Rendimento Efficiency %	Circuito di armatura Armature circuit			Max giri Max. speed (°)					
	220	400	440	460	470	520	600				Corrente Current Amp	Res. 115°C mOhm	Ind. mH						
52	315	---	---	---	---	---	---	15.2	461	72.0	96.0	572	15.0	536					
		660	---	---	---	---	---	31.9	462	83.1	96.0								
		735	---	---	---	---	---	---	35.6	463	84.3				96.0				
			775	---	---	---	---	---	37.5	462	84.9				96.0				
		795	---	---	---	---	---	---	38.4	461	85.1				96.0				
			890	---	---	---	---	---	43.1	462	86.3				96.0				
		1045	---	---	---	---	---	---	50.5	462	87.7				96.0				
		53	270	---	---	---	---	---	---	13.3	470				69.5	87.0	706	18.4	468
585	---			---	---	---	---	28.6	467	82.2	87.0								
650	---			---	---	---	---	---	32.0	470	83.6	87.0							
	685			---	---	---	---	---	33.8	471	84.5	87.0							
705	---			---	---	---	---	---	34.6	469	84.6	87.0							
	790			---	---	---	---	---	38.9	470	86.0	87.0							
54	255			---	---	---	---	---	---	12.3	461	68.2	82.0	777	20.2	438			
				550	---	---	---	---	---	26.7	464	81.4	82.0						
		615	---	---	---	---	---	---	29.9	464	82.9	82.0							
			650	---	---	---	---	---	31.5	463	83.5	82.0							
		665	---	---	---	---	---	---	32.3	464	83.8	82.0							
			---	---	---	---	---	---	---	---	---	---	---				---	---	---
55	210	---	---	---	---	---	---	10.3	468	65.0	72.0	1004	26.5	366					
		470	---	---	---	---	---	23.0	467	79.9	72.0								
		525	---	---	---	---	---	---	25.9	471	81.8				72.0				
			555	---	---	---	---	---	27.3	470	82.4				72.0				
		570	---	---	---	---	---	---	28.0	469	82.7				72.0				
			640	---	---	---	---	---	31.5	470	84.1				72.0				
		56	405	---	---	---	---	---	---	19.7	465				77.0	64.0	1292	33.2	684
455	---			---	---	---	---	22.2	466	78.8	64.0								
480	---			---	---	---	---	---	23.5	468	79.8	64.0							
	495			---	---	---	---	---	24.1	465	80.1	64.0							
560	---			---	---	---	---	---	27.2	464	81.7	64.0							
	660			---	---	---	---	---	32.2	466	83.9	64.0							
57	355			---	---	---	---	---	---	17.4	468	75.7	57.5	1563	41.6	603			
				400	---	---	---	---	---	19.7	470	77.9	57.5						
		425	---	---	---	---	---	---	20.8	467	78.6	57.5							
			435	---	---	---	---	---	21.4	470	79.2	57.5							
		494	---	---	---	---	---	---	24.2	468	80.9	57.5							
			---	---	---	---	---	---	---	---	---	---	---				---	---	---
58	315	---	---	---	---	---	---	15.2	461	73.1	52.0	1912	50.1	533					
		355	---	---	---	---	---	17.3	465	75.6	52.0								
		375	---	---	---	---	---	---	18.3	466	76.5				52.0				
			385	---	---	---	---	---	18.8	466	76.9				52.0				
		420	---	---	---	---	---	---	20.5	466	75.8				52.0				
			---	---	---	---	---	---	---	---	---				---	---	---	---	---

Nota (\*) - VENTILAZIONE SOLO L.O. / FAN ONLY SIDE COMMUTATOR

Nota (°) - Regolazione di campo / Field weakening



Potenza eccitazione Excitation power (w)	1500	Tipo Size MGL 160 X2 Ventilazione Ventilation IC 06
Cost. tempo eccitaz. Field time constant (ms)	357	
Massa del motore Mass of the motor (Kg)	403	
Momento d'inerzia rotore Rotor inertia moment (Kgm2)	0.47	

Avv.	Velocità nominale n/min a tensione nominale di armatura Rated speed (rev/min) at rated voltage							Potenza Power kW	Coppia vel.nomin. Torque at rated speed Nm	Rendimento Efficiency %	Circuito di armatura Armature circuit			Max giri Max. speed (°)			
	220	400	440	460	470	520	600				Corrente Current Amp	Res. 115°C mOhm	Ind. mH				
59		280	---	---	---	---	---	14.0	478	71.4	49.0	2190	59.8	479			
			320	---	---	---	---	15.9	475	73.7	49.0						541
				335	---	---	---	16.9	482	75.0	49.0						61
					345	---	---	17.4	482	75.6	49.0						589
						395	---	19.8	479	77.7	49.0						667
							470	23.6	480	80.3	49.0						793
60		245	---	---	---	---	---	12.4	483	68.1	45.5	2628	68.5	433			
			280	---	---	---	---	14.2	484	70.9	45.5						491
				300	---	---	---	15.1	481	72.1	45.5						521
					310	---	---	15.6	481	72.9	45.5						535
						355	---	17.8	479	75.2	45.5						607
61		220	---	---	---	---	---	10.9	473	65.7	41.5	3131	81.7	390			
			255	---	---	---	---	12.6	472	69.0	41.5						444
				270	---	---	---	13.4	474	70.2	41.5						471
					280	---	---	13.8	471	70.8	41.5						484
						320	---	15.8	472	73.2	41.5						551
							385	19.1	474	76.7	41.5						659
62			230	---	---	---	---	11.0	457	65.8	38.0	3694	95.0	404			
				245	---	---	---	11.8	460	67.5	38.0						429
					250	---	---	12.1	462	67.7	38.0						441
						290	---	14.0	461	70.9	38.0						504
							350	17.0	464	74.6	38.0						605

Nota (\*) - VENTILAZIONE SOLO L.O. / FAN ONLY SIDE COMMUTATOR

Nota (°) - Regolazione di campo / Field weakening



**MOTORI C.C. SERIE MGL**  
**GLEICHSTROMMOTOREN SERIE MGL**  
**D.C. MOTORS SERIES MGL**

Forma costr. IM B3/B5 e derivate - Mounting IM B3/B5 and derived  
 Protezione IP23S - Protection IP23S  
 Ventilazione IC06 - Cooling IC06

**IN H 03**

Foglio/Seite/Sheet  
 D 09 93

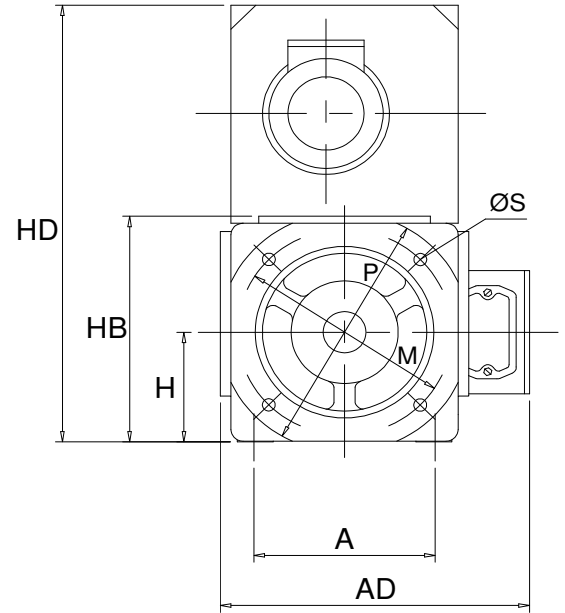
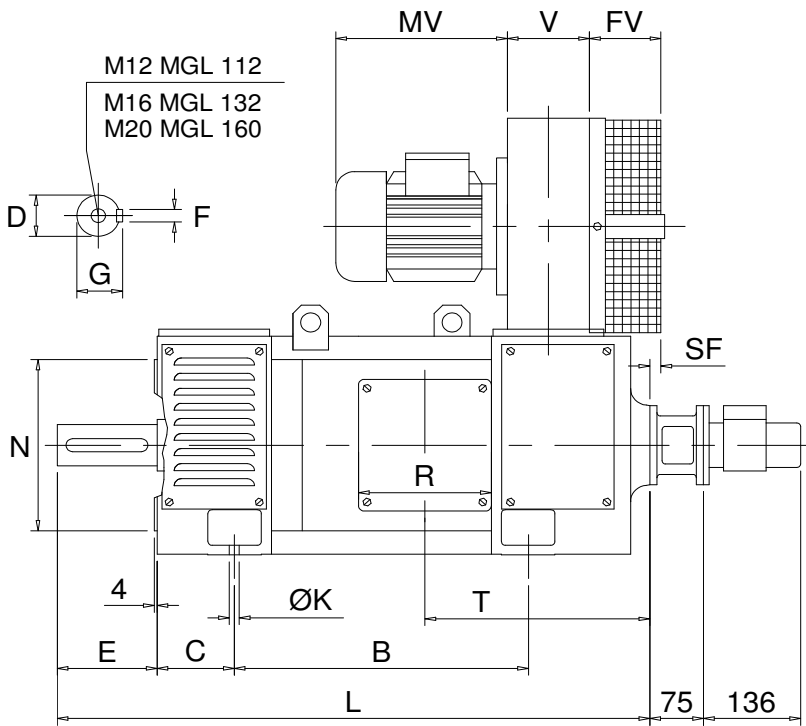

MGL 160: MORSETTIERA RETTANGOLARE mm 200 x 270  
 MGL 160: RECTANGULAR TERMINAL BOARD mm 200 x 270

QUOTE MORSETTIERA	TIPO	R	T
	MGL 112	170	240
DIMENSION TERMINAL BOARD	MGL 132	200	270
	MGL 160	200	325

TIPO	PIAZZAMENTO					ALBERO				FLANGIA				INGOMBRO				ELETTOVENT.				
	A	B	C	H	K	E	D	F	G	M	N	S	P	HD	HB	L	AD	FV	MV	V	SF	
112	S	288														550						
	M	190	318	70	112	12	80	38	10	41	215	180	14	250	445	233	580	325	65	185	92	22
	L		358														620					
132	S		330														656					
	M	216	370	89	132	12	110	48	14	51,5	265	230	14	300	525	273	696	395	70	211	115	34
	L		420														746					
	P		470														796					
160	K		342														760					
	S		372														790					
	M		412														830					
	L	254	462	108	160	14	140	60	18	64	300	250	18	350	630	329	880	450	73	211	135	10
	P		492														910					
	X2		572														990					

**TOLLERANZE SU QUOTE DI  
ACCOPPIAMENTO**

Tables: T1

**TOLERANCE ON CONNECTION QUOTAS**18.05.2007  
Sheet N°

	Dimensioni / Size	Tolleranza Tolerance
TOLLERANZA SU DIAMETRO <b>D</b> DELLA SPORGENZA D'ALBERO	Fino a $D = 28$ mm Untill $D = 28$ mm	j6
TOLERANCE ON DIAMETER <b>D</b> OF SHAFT END	Per $D = 32 \div 48$ mm For $D = 32 \div 48$ mm	k6
	Per $D$ superiore a 48 mm For $D$ higher than 48 mm	m6
LINGUETTA TANG	Per tutte For all	h9
FLANGIA B5 E DERIVATE QUOTA <b>N</b> DI CATALOGO	Per $N$ fino a $\varnothing = 230$ mm For $N$ untill $\varnothing = 230$ mm	j6
B5 FLANGE AND DERIVATIVES QUOTA <b>N</b> ON CATALOGUE	Per $N$ oltre a $\varnothing = 230$ mm For $N$ more than $\varnothing = 230$ mm	h6
ALTEZZA D'ASSE <b>H</b> DI CATALOGO HEIGHT AXIS <b>H</b> ON CATALOGUE	Per tutte For all	0 -0.5



PIAZZAMENTO - QUOTE AUSILIARIE

18.05.2007  
Sheet N°

PLACEMENT - AUXILIARY DIMENSION

Tables N°

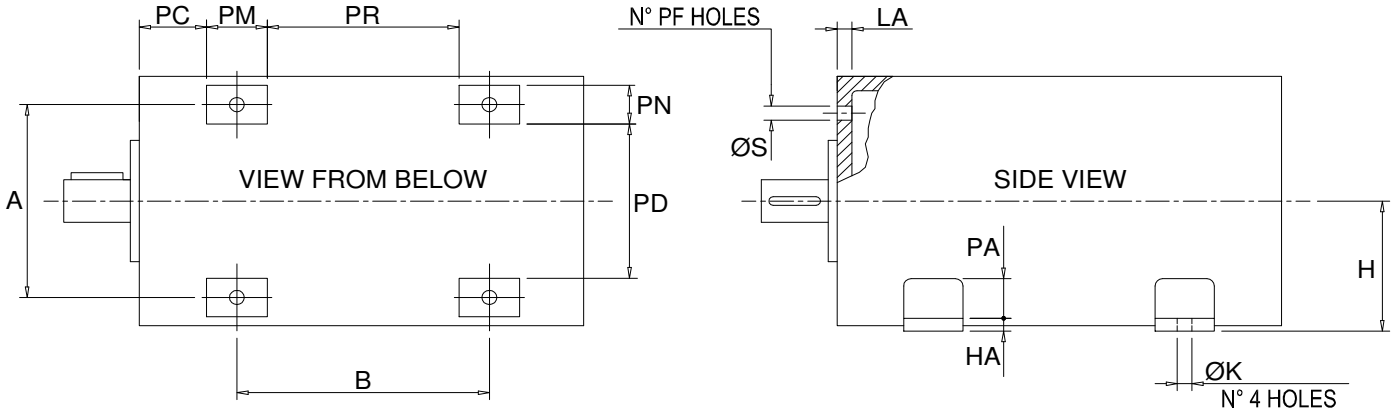

TIPO/TYPE	A	PD	PN	PC	PM	PR	B	K	S	PF	LA	PA	HA	H	
80	S	170	123	36	57	55	100	160	9	11.5	4	16	31	9	80
	M						125	185							
	L						160	220							
100	S	216	150	45	54	65	132	192	12	14	4	20	35	10	100
	M						157	217							
	L						192	252							
112	S	190	146	31	48	52	228	288	12	14	4	16	40	15	112
	M						258	318							
	L						298	358							
132	S	216	172	38	62	55	275	330	12	14	4	20	40	15	132
	M						315	370							
	L						365	420							
160	P	254	200	50	71	75	415	470	14	18	4	25	52	15	160
	K						268	342							
	S						298	372							
	M						338	412							
	L						388	462							
P	418	492													



Tabella quote per bocchette di  
adattamento ventilazione separata

18.05.2007  
Sheet N°

Dimensions table of adapted openings  
for separated ventilation

Tables N° 40

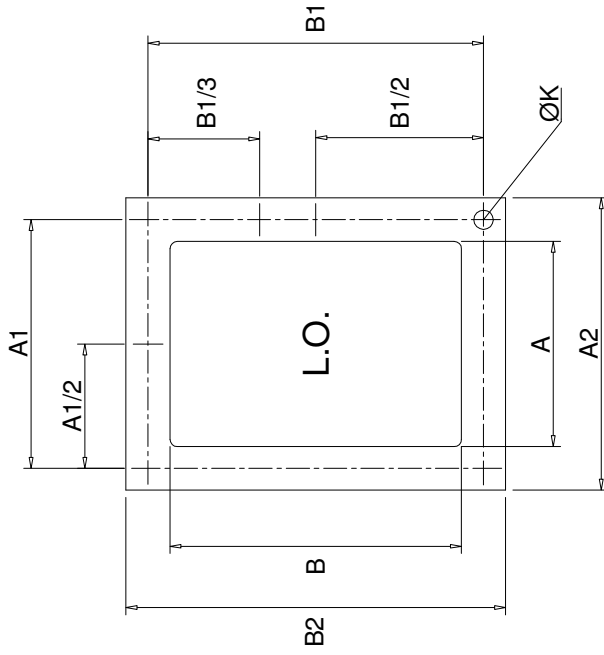

A1/2 = B1/2 = N° 8 FORI  
B1/3 = N° 10 FORI  
A1/2 = B1/2 = N° 8 HOLES  
B1/3 = N° 10 HOLES

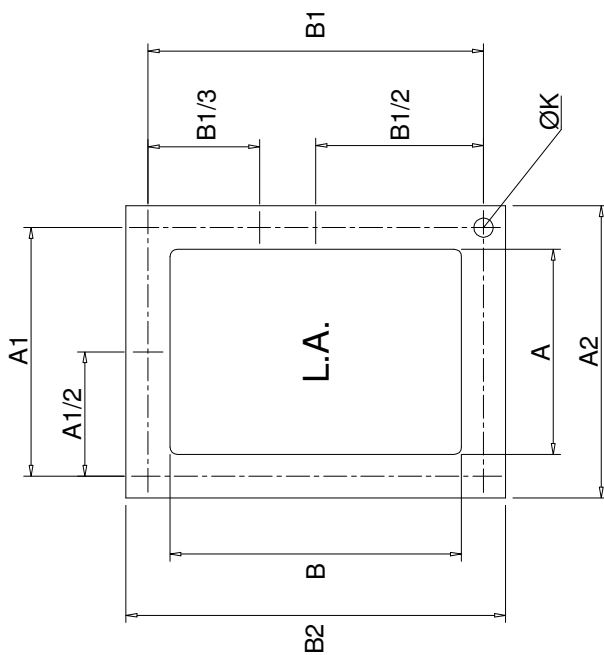

A	B	A1	B1	A2	B2	TIPO
ON TOP / SUPERIORI						80
98	145	108	160	120	172	
ON SIDE / LATERALI						100
98	90	108	90	120	105	
ON TOP / SUPERIORI						100
100	170	113	178	125	134	
ON SIDE / LATERALI						100
100	120	113	122	125	190	
85	140	98	145	110	155	112
105	180	118	185	130	197	132
115	210	135	220	155	240	160

FORI / HOLES	
N°	K
4	6
4	7

TIPO	A	B	A1	B1	A2	B2
ON TOP / SUPERIORI						
80	90	145	108	160	120	172
	ON SIDE / LATERALI					
100	90	90	108	90	120	105
	ON TOP / SUPERIORI					
100	90	170	113	178	125	190
	ON SIDE / LATERALI					
112	90	120	113	122	125	134
	70	140	98	145	110	155
132	90	180	118	185	130	197
160	110	210	135	220	155	240

