

# CEAR



## MOTORI ELETTRICI A CORRENTE CONTINUA PER APPLICAZIONI INDUSTRIALI

## DIRECT CURRENT ELECTRIC MOTORS FOR INDUSTRIAL APPLICATIONS

### SERIE MGLC COMPENSATI

GRANDEZZE 160 - 400 (4 POLI)  
GRANDEZZA 500 (6 POLI)

POTENZE DA 20 A 1900 KW (a 1000 rpm)  
COPPIE DA 185 A 18500 Nm

### MGLC SERIES COMPENSATED

SIZE 160 - 400 (4 POLES)  
SIZE 500 (6 POLES)

POWER FROM 20 TO 1900 KW (at 1000 rpm)  
TORQUE FROM 185 TO 18500 Nm





## MOTORI ELETTRICI A CORRENTE CONTINUA DIRECT CURRENT ELECTRIC MOTORS

<b>Indice</b>	<b>Index</b>	
Produzione CEAR.....	CEAR production.....	Pag. 3
Isolamento.....	Insulation.....	Pag. 4
Rappresentazione grafica.....	Graphical representation.....	Pag. 5
Lista componenti.....	Parts list.....	Pag. 6
Forme costruttive.....	Construction form.....	Pag. 7
Metodi di raffreddamento.....	Methods of cooling.....	Pag. 9
Tipi di servizio.....	Duty types.....	Pag. 11
Caratteristiche generali.....	General characteristics.....	Pag. 15
Grafici selezione motori.....	Graphics motor selection.....	Pag. 16
Motori taglia MGLC 160.....	Motors size MGLC 160.....	Pag. 19
Motori taglia MGLC 180.....	Motors size MGLC 180.....	Pag. 34
Motori taglia MGLC 200.....	Motors size MGLC 200.....	Pag. 52
Disegni d'ingombro MGLC 160-180-200.....	Motors dimensions MGLC 160-180-200.....	Pag. 77
Motori taglia MGLC 250.....	Motors size MGLC 250.....	Pag. 78
Motori taglia MGLC 280.....	Motors size MGLC 280.....	Pag. 102
Disegni d'ingombro MGLC 250-280.....	Motors dimensions MGLC 250-280.....	Pag. 117
Motori taglia MGLC 315.....	Motors size MGLC 315.....	Pag. 118
Motori taglia MGLC 400.....	Motors size MGLC 400.....	Pag. 146
Disegni d'ingombro MGLC 315-400.....	Motors dimensions MGLC 315-400.....	Pag. 176
Motori taglia MGLC 500.....	Motors size MGLC 500.....	Pag. 177
Disegni d'ingombro MGLC 500.....	Motors dimensions MGLC 500.....	Pag. 201
Tolleranze su quote di accoppiamento.....	Tolerances of connecting dimensions.....	Pag. 202
Piazzamento-Quote ausiliarie.....	Placement-Auxiliary dimension.....	Pag. 203
Tabella quote per bocchette di ventilazione separata.....	Dimensions table of adapted openings for separated ventilation.....	Pag. 204
Richiesta di assistenza e parti di ricambio.....	Inquiry of assistance and spare parts.....	Pag. 205



## MOTORI ELETTRICI A CORRENTE CONTINUA DIRECT CURRENT ELECTRIC MOTORS

### **PRODUZIONE CEAR**

Tutte le macchine costruite dalla ditta CEAR sono conformi alle norme CEI EN 60034-1 classificazione 2-3 fascicolo n°11111 (data di pubblicazione 2011), per le macchine elettriche rotanti ed alle raccomandazioni internazionali IEC.

Il collaudo viene eseguito su ogni macchina, secondo quanto stabilito dalle suddette norme, onde accertarne il corretto funzionamento.

Sono inoltre considerate esecuzioni rispondenti a particolari esigenze delle ditte committenti nel rispetto di eventuali normative estere e della buona regola d'arte.

### **CEAR PRODUCTION**

All motors made by company CEAR are in accordance with the norms CEI EN 60034-1 classification 2-3 fasc. n°11111 (publication date 2011), for the electrical rotating machines and with the IEC international recommendations.

Every motor is tested as established from the above mentioned norms in order to verify the correct operation.

We are at complete disposal for eventual execution of motors answering to particular needs of our customers ever in the respect of eventual foreign norms and executed to art rule.



## **ISOLAMENTO**

I motori della serie MGL e MGLC sono costruiti utilizzando materiali con isolamento in classe H.  
La sovratemperatura ammessa per la classe H dalle norme CEI EN 60034-1 classificazione 2-3 fascicolo n°11111 (data pubblicazione 2011), è pari a  $\Delta T = 125^\circ\text{C}$ .

I motori indicati sul catalogo sono previsti per sovratemperature, relative alla classe F, pari a  $\Delta T = 105^\circ\text{C}$ .

I motori vengono perciò utilizzati per una sovratemperatura inferiore mediamente del 20% offrendo così un più elevato grado di affidabilità.

## **INSULATION**

Motors of series MGL and MGLC are constructed using material with insulation class H.  
The overtemperature admitted for the class from the norms CEI EN 60034-1 classification 2-3 fasc. n°11111 (publication date 2001), is like  $\Delta T = 125^\circ\text{C}$ .

Motors indicated on the catalogue are provided for overtemperature of class F, like to  $\Delta T = 105^\circ\text{C}$ .

Motors are therefore used for a lower overtemperature of 20% on average, offering an higher reliability level.



**Motori Serie MGL**  
**Motoren Serie MGL**  
**Motor Series MGL**

Tabella / Tisch / Tables  
N° 3

Foglio / Seite / Sheet  
N° 1

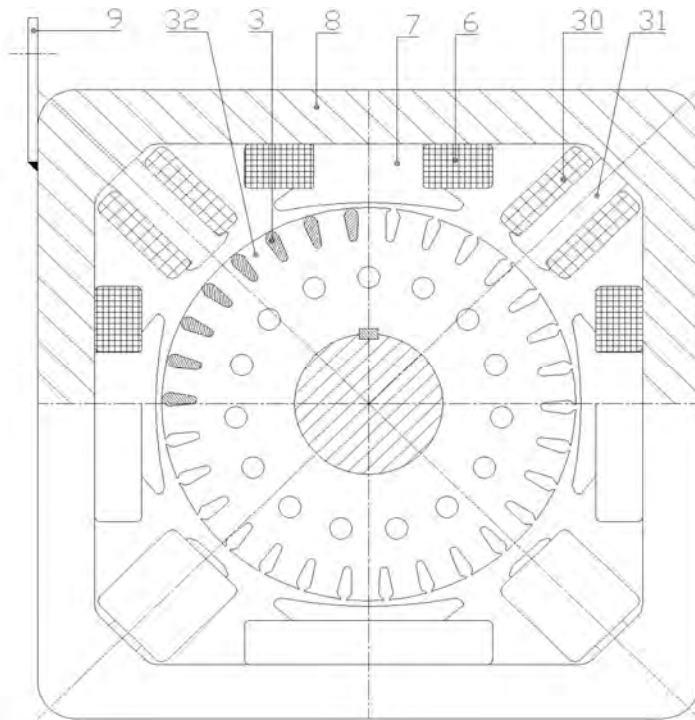

RAPPRESENTAZIONE GRAFICA  
MOTORE SERIE MGL

DRAWINGS  
MOTOR SERIAL MGL

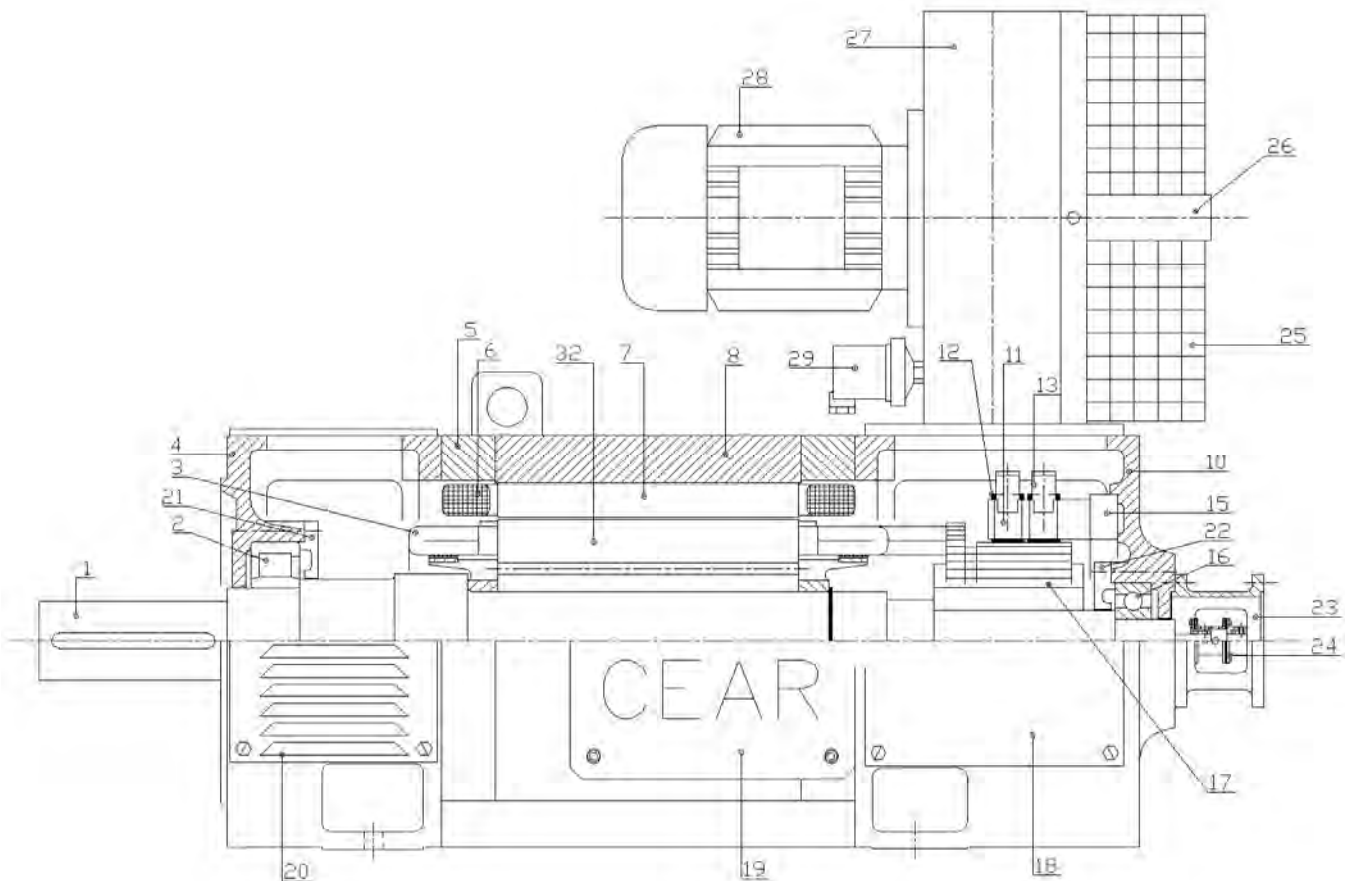



**Motori Serie MGL  
Motoren Serie MGL  
Motor Series MGL**

Tabella / Tisch / Tables  
N° 3

Foglio / Seite / Sheet  
N° 2

**LISTA COMPONENTI**





**MOTORE SERIE MGL**

**PARTS LISTS**

**MOTOR SERIAL MGL**

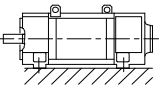
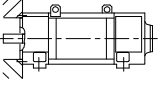
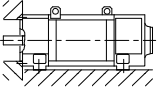
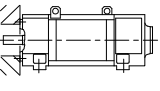
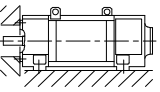
1	Sporgenza d'albero .....	Shaft end
2	Cuscinetto lato accoppiamento .....	Bearing coupling side
3	Avvolgimento del rotore .....	Engine winding up
4	Scudo lato accoppiamento .....	Coupling shield side
5	Viti di fissaggio scudi - statore .....	Fixing screws shield-box
6	Bobina poli principali .....	Coil mains poles
7	Nucleo poli principali .....	Nucleous mains poles
8	Statore Lamellare .....	Blades package stator
9	Golfari di sollevamento .....	Lifting ring
10	Scudo lato opposto .....	Opposite shield side
11	Cassetto portaspazzole e spazzole .....	Drawer brushes-holder
12	Spazzole .....	Brushes
13	Molle spingi spazzole .....	Spring
15	Anello portaspazzole .....	Brushes-holder ring
16	Cuscinetto lato opposto .....	Bearing opposite side
17	Collettore .....	Collector
18	Portello ispezione lato opposto .....	Opposite side inspection door
19	Scatola Morsettiera .....	Terminal board
20	Portello lato accoppiamento .....	Coupling side door
21	Coperchietto interno lato accopp. ....	Coupling side interior small-cover
22	Coperchietto interno lato opposto .....	Opposite side interior small-cover
23	Lanterna attacco D.T. ....	Lantern for Tachogenerator
24	Giunto elastico di adattamento D.T. ....	Elastic Joint for tachogenerator
25	Filtro Ventilatore .....	Ventilator filter
26	Staffe di sostegno filtro .....	Support filter stirrups
27	Voluta ventiatore .....	Ventilator carter
28	Motore ventilatore .....	Ventilator engine
29	Relè anemostatico .....	Air flow control relay
30	Bobina poli ausiliari .....	Auxiliarys poles bobbin
31	Nucleo poli ausiliari .....	Nucleus auxiliarys poles
32	Pacco rotore .....	Rotor package



Figura Sketch	CEI EN 60034-7		UNEL 05513	
	Cod. II	Cod. I		
	IM 1001	IM B3	B3	Fissata mediante piedi; piedi disposti verso il basso Mounted by feet, feet down
	IM 3001	IM B5	B5	Fissata sul lato della flangia con fori passanti, rivolto verso il lato comando Mounted by on D-end side of flange
	IM 2001	IM B35	B3/B5	Fissata mediante piedi disposti verso il basso; fissaggio ulteriore sul lato della flangia con fori passanti rivolto verso il lato comando Mounted by feet, feet down, with additional mounting on D-end side of flange
	IM 3601	IM B14	B14	Fissata sul lato della flangia con fori filettati, rivolto verso il lato comando Mounted by on D-end side of flange with tapped holes
	IM 2101	IM B34	B3/B14	Fissata mediante piedi, piedi disposti verso il basso. Fissaggio ulteriore sul lato della flangia con fori filettati rivolto verso il lato comando. Mounted by feet, feet down, with additional mounting on D-end side of flange with tapped holes
	IM 1051	IM B6	B6	Fissata mediante piedi; piedi a sinistra (visti dal lato comando) Mounted by feet, feet left (viewed from D-end)
	IM 1061	IM B7	B7	Fissata mediante piedi; piedi a destra (visti dal lato comando) Mounted by feet, feet right (viewed from D-end)
	IM 1070	IM B8	B8	Fissata mediante piedi; piedi disposti verso l'alto Mounted by feet, feet up





Forme costruttive  
Construction Forms

18.05.2007  
Sheet N° 10

Macchine ad asse verticale  
Machines with vertical shaft

Tables N° 05

Figura Sketch	CEI EN 60034-7		UNEL 05513	
	Cod. II	Cod. I		
	IM 1011	IM V5	V5	Fissata mediante piedi; lato comando in basso Mounted by feet, D-end down
	IM 1031	IM V6	V6	Fissata mediante piedi; lato comando in alto Mounted by feet, D-end up
	IM 3031	IM V3	V3	Fissata sul lato della flangia con fori passanti rivolto verso il lato comando, lato comando in alto Mounted on D-end side of flange, D-end up
	IM 3011	IM V1	V1	Fissata sul lato della flangia con fori passanti, rivolto verso il lato comando, lato comando in basso Mounted on D-end side of flange, D-end down
	IM 2031	IM V36	V3/V6	Fissata mediante piedi; fissaggio ulteriore sulla flangia con fori passanti dal lato comando; lato comando in alto Mounted by feet, feet down, with additional mounting on D-end side of flange, D-end up
	IM 2011	IM V15	V1/V5	Fissata mediante piedi; fissaggio ulteriore sulla flangia con fori passanti dal lato comando; lato comando in basso Mounted by feet, feet down, with additional mounting on D-end side of flange, D-end down
	IM 3611	IM V18	V18	Fissata sul lato della flangia con fori filettati, dal lato comando, lato comando in basso Mounted by on D-end side of flange with tapped holes, D-end down
	IM 3631	IM V19	V19	Fissata sul lato della flangia con fori filettati, dal lato comando, lato comando in alto Mounted by on D-end side of flange with tapped holes, D-end up





Figura Sketch	CEI EN 60034-6 Semplificata Simplified	CEI EN 60034-6 Completo Complete	Descrizione Description	CEI EN 60034-5 Grado di Protezione Degrees of Protection
	IC 0 0	IC 0 A 0	Macchina raffreddata naturalmente Free convection	
	IC 0 1	IC 0 A 1	Macchina autoventilata Self-circulation	
	IC 1 1	IC 1 A 1	Macchina autoventilata con canale di aspirazione Self-circulation Inlet pipe duct circulated	
	IC 0 6	IC 0 A 6	Macchina raffreddata mediante dispositivo indipendente aspirante montato assialmente sulla macchina Circulation by machine-mounted axial Inlet independent component	IP 23
	IC 0 6	IC 0 A 6	Macchina raffreddata mediante dispositivo indipendente premente montato assialmente sulla macchina Circulation by machine-mounted axial Outlet independent component	
	IC 0 6	IC 0 A 6	Macchina raffreddata mediante dispositivo indipendente montato sulla macchina Circulation by machine-mounted independent component	
	IC 1 6	IC 1 A 6	Macchina raffreddata mediante dispositivo indipendente montato sulla macchina con canale di aspirazione Circulation by machine-mounted independent component, Inlet pipe duct circulated	
	IC 2 6	IC 2 A 6	Macchina raffreddata mediante dispositivo indipendente montato sulla macchina con canale di scarico Circulation by machine-mounted independent component, Outlet pipe duct circulated	

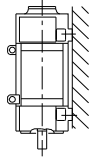
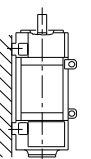
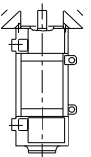
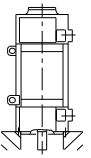
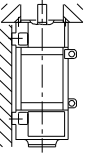
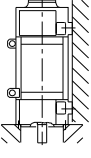
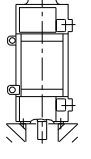
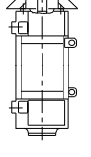

Metodi di Raffreddamento delle macchine elettriche rotanti

Rotating electrical machines, Methods of cooling

19.05.2007  
Sheet N° 01

Tables N° 08

Figura Sketch	CEI EN 60034-6 Semplificata Simplified	CEI EN 60034-6 Completo Complete	Descrizione Description	CEI EN 60034-5 Grado di Protezione Degrees of Protection
	IC 1 7	IC 1 A 7	Macchina raffreddata mediante dispositivo separato e indipendente, mediante pressione della rete di distribuzione  Circulation by separate and independent component, by coolant pressure system	IP 23
	IC 410	IC 4A1A0	Macchina chiusa raffreddata naturalmente  Free-convection	
	IC 416	IC 4A1A6	Macchina chiusa raffreddata superficialmente, mediante dispositivo indipendente montato sulla macchina  Frame surface cooled, circulation by machine-mounted independent component	
	IC 3 6	IC 3 A 6	Macchina raffreddata mediante dispositivo indipendente montato sulla macchina, canali di aspirazione e scarico  Circulation by machine-mounted independent component, Inlet and Outlet pipe duct circulated	
	IC 3 7	IC 3 A 7	Macchina raffreddata mediante dispositivo separato e indipendente, canali di aspirazione e scarico  Circulation by separate and independent component, Inlet and Outlet pipe duct circulated	IP 44
	IC 00 66	IC 6A6A0	Scambiatore di calore montato sulla macchina, circolazione mediante dispositivo indipendente.  Machine-mouted heat exchanger, circulation by independent component	
	IC W37A86	IC 8A6W7	Scambiatore di calore montato sulla macchina, circolazione mediante dispositivo indipendente. Aria-Acqua  Machine-mouted heat exchanger, circulation by independent component. Air-Water cooling	
	IC 06 66	IC 6A6A6	Scambiatore di calore montato sulla macchina, circolazione mediante dispositivo indipendente. Aria-Aria  Machine-mouted heat exchanger, circulation by independent component. Air-Air cooling	



**TIPI DI SERVIZIO E IDENTIFICAZIONE DEL SERVIZIO**

Tabella/Tables  
N° 9

**DUTY TYPES AND DECLARATION OF DUTY**

Foglio/Sheet  
N° 1

----- Max  
T: Temperature    - - - - - Average  
                              ———— Instantaneous

P: Carico load

Pv: Perdite elettriche  
Electrical losses

**Servizio continuo S1**

Funzionamento a carico costante di durata sufficiente a consentire alla macchina il raggiungimento dell'equilibrio termico.  
L'abbreviazione appropriata è S1.

**Continuous running duty S1**

Operation at a constant load maintained for sufficient time to allow the machine to reach thermal equilibrium.  
The appropriate abbreviation is S1.

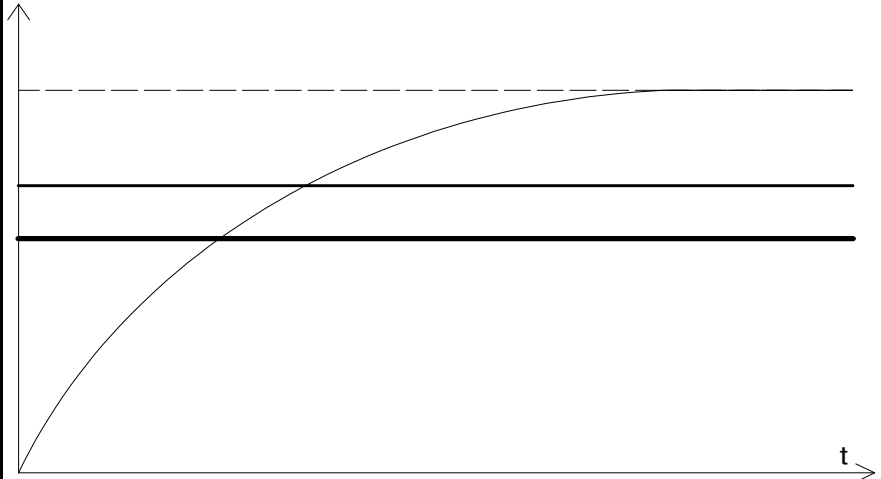

**Servizio di durata limitata S2**

Funzionamento a carico costante per un periodo di tempo determinato, inferiore a quello richiesto per raggiungere l'equilibrio termico, seguito da un tempo di riposo di durata sufficiente a ristabilire l'uguaglianza fra la temperatura della macchina e quella del fluido di raffreddamento, con una tolleranza di 2 K.  
L'abbreviazione appropriata è S2, seguita dall'indicazione della durata del servizio.

**Short - time duty S2**

Operation at constant load for a given time, less than that required to reach thermal equilibrium, followed by a time de-energized and at rest of sufficient duration to re-establish machine temperatures within 2 K of the coolant temperature.  
The appropriate abbreviation is S2, followed by an indication of the duration of the duty.

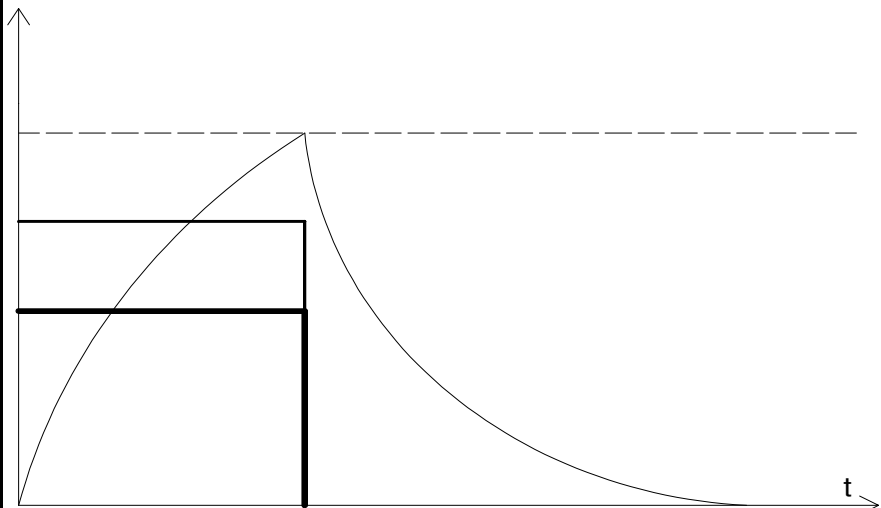

**Servizio intermittente periodico S3<sup>(1)</sup>**

Sequenza di cicli di funzionamento identici, ciascuno comprendente un tempo di funzionamento a carico costante ed un tempo di riposo. In questo servizio il ciclo è tale che la corrente di avviamento non influenza la sovratemperatura in maniera significativa.  
L'abbreviazione appropriata è S3, seguita dall'indicazione del rapporto di intermittenza Ri.

**Intermittent periodic duty S3<sup>(1)</sup>**

A sequence of identical duty cycles, each including a time of operation at constant load and a time de-energized and at rest. In this duty, the cycle is such that the starting current does not significantly affect the temperature rise.  
The appropriate abbreviation is S3, followed by the cyclic duration factor Ri.

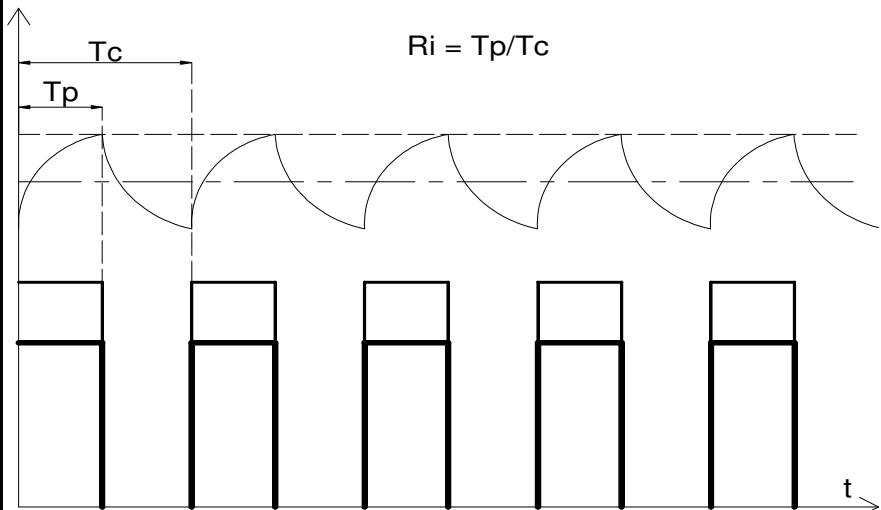

(1) Il servizio periodico implica che l'equilibrio termico non è raggiunto durante il periodo a carico.

(1) Periodic duty implies that thermal equilibrium is not reached during the time on load.



## TIPI DI SERVIZIO E IDENTIFICAZIONE DEL SERVIZIO

Tabella/Tables  
N° 9

## DUTY TYPES AND DECLARATION OF DUTY

Foglio/Sheet  
N° 2

----- Max  
T: Temperature    - - - - - Average  
————— Instantaneous

P: Carico  
load

Pv: Perdite elettriche  
Electrical losses

### Servizio intermittente periodico con avviamento S4<sup>(1)</sup>

Sequenza di cicli di funzionamento identici, ciascuno comprendente un tempo non trascurabile di avviamento, un tempo di funzionamento a carico costante ed un tempo di riposo.

L'abbreviazione appropriata è S4, seguita dal rapporto di intermittenza Ri, dal momento d'inerzia del motore e dal momento d'inerzia del carico, questi ultimi due riferiti all'albero motore.

### Intermittent periodic duty with starting S4<sup>(1)</sup>

A sequence of identical duty cycles, each cycle including a significant starting time, a time of operation at constant load and a time de-energized and at rest. The appropriate abbreviation is S4, followed by the cyclic duration factor Ri, the moment of inertia of the motor and the moment of inertia of the load, both referred to the motor shaft.

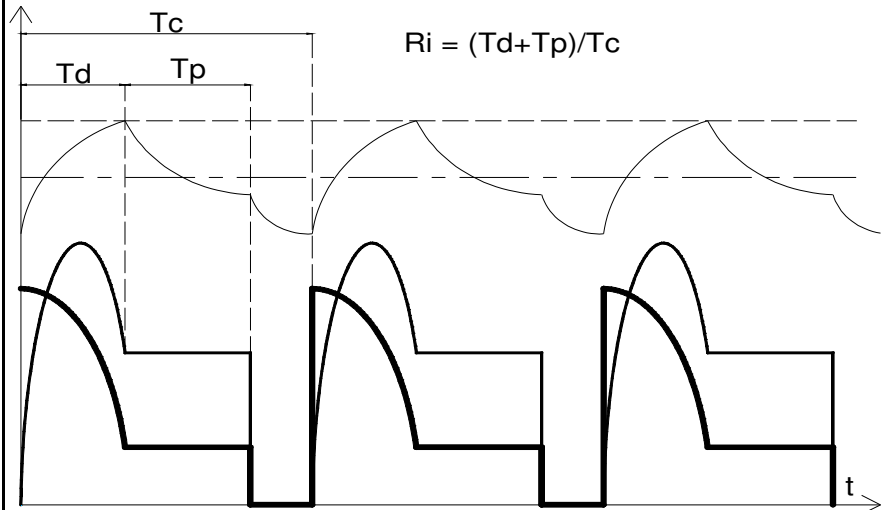

### Servizio intermittente periodico con frenatura elettrica S5<sup>(1)</sup>

Sequenza di cicli di funzionamento identici, ciascuno comprendente un tempo di avviamento, un tempo di funzionamento a carico costante, un tempo di frenatura elettrica rapida ed un tempo di riposo.

L'abbreviazione appropriata è S5, seguita dal rapporto di intermittenza Ri, dal momento d'inerzia del motore e dal momento d'inerzia del carico, questi ultimi due riferiti all'albero motore.

### Intermittent periodic duty with electric braking S5<sup>(1)</sup>

A sequence of identical duty cycles, each cycle consisting of a starting time, a time of operation at constant load, a time of electric braking and a time de-energized and at rest.

The appropriate abbreviation is S5, followed by the cyclic duration factor Ri, the moment of inertia of the motor and the moment of inertia of the load, both referred to the motor shaft.

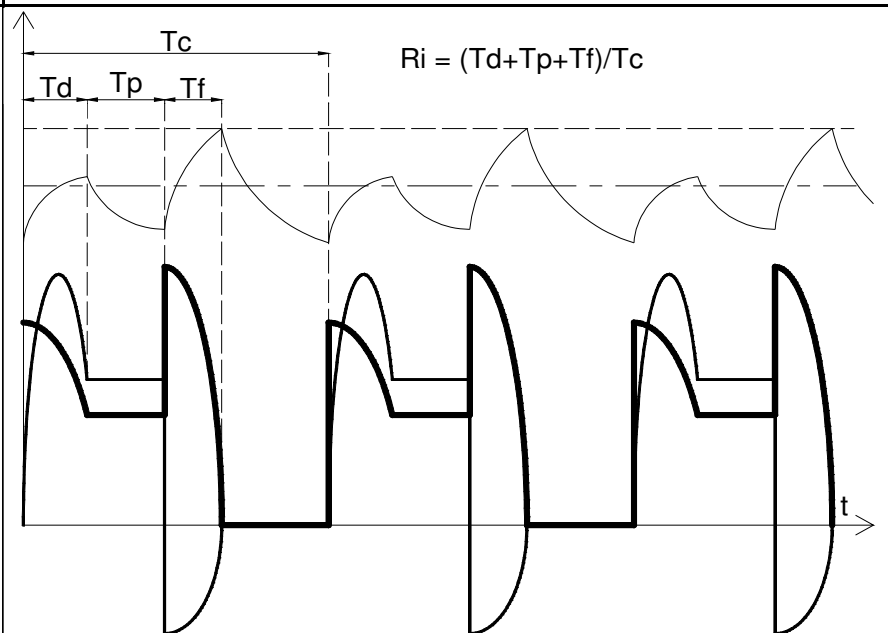

### Servizio ininterrotto periodico S6<sup>(1)</sup>

Sequenza di cicli di funzionamento identici, ciascuno comprendente un tempo di funzionamento a carico costante ed un tempo di funzionamento a vuoto. Non esiste alcun tempo di riposo.

L'abbreviazione appropriata è S6, seguita dal rapporto d'intermittenza Ri.

### Continuous-operation periodic duty S6<sup>(1)</sup>

A sequence of identical duty cycles, each cycle consisting of a time of operation at constant load and a time of operation at no-load. There is no time de-energized and at rest.

The appropriate abbreviation is S6, followed by the cyclic duration factor Ri.

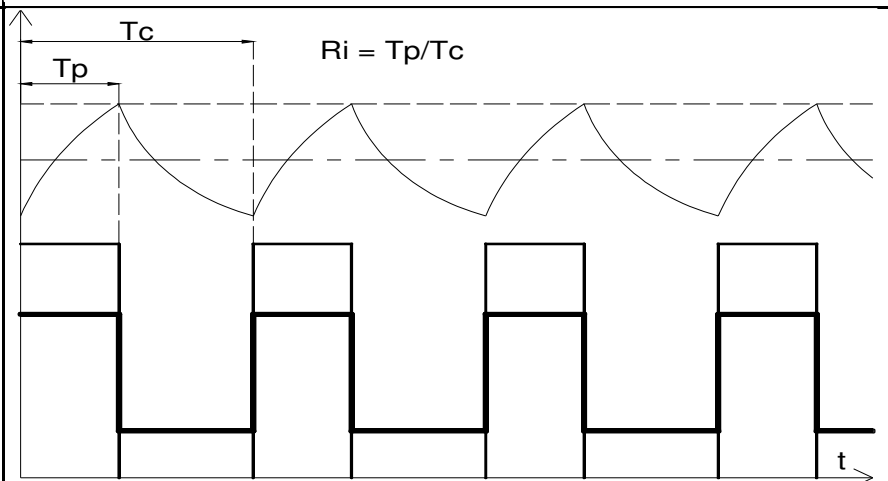

(1) Il servizio periodico implica che l'equilibrio termico non è raggiunto durante il periodo a carico.

(1) Periodic duty implies that thermal equilibrium is not reached during the time on load.



## TIPI DI SERVIZIO E IDENTIFICAZIONE DEL SERVIZIO

Tabella/Tables  
N° 9

## DUTY TYPES AND DECLARATION OF DUTY

Foglio/Sheet  
N° 3

----- Max  
 T: Temperature    - - - - - Average  
 ————— Instantaneous

P: Carico load

Pv: Perdite elettriche Electrical losses

n: Velocità speed

**Servizio ininterrotto periodico con frenatura elettrica S7<sup>(1)</sup>**  
 Sequenza di cicli di funzionamento identici, ciascuno comprendente un tempo di avviamento, un tempo di funzionamento a carico costante ed un tempo di frenatura elettrica. Non esiste alcun periodo di riposo. L'abbreviazione appropriata è S7, seguita dal momento d'inerzia del motore e dal momento d'inerzia del carico, entrambi riferiti all'albero motore.

**Continuous-operation periodic duty with electric braking S7<sup>(1)</sup>**

A sequence of identical duty cycles, each cycle consisting of a starting time, a time of operation at constant load and a time of electric braking. There is no time de-energized and at rest. The appropriate abbreviation is S7, followed by the moment of inertia of the motor and the moment of inertia of the load, both referred to the motor shaft.

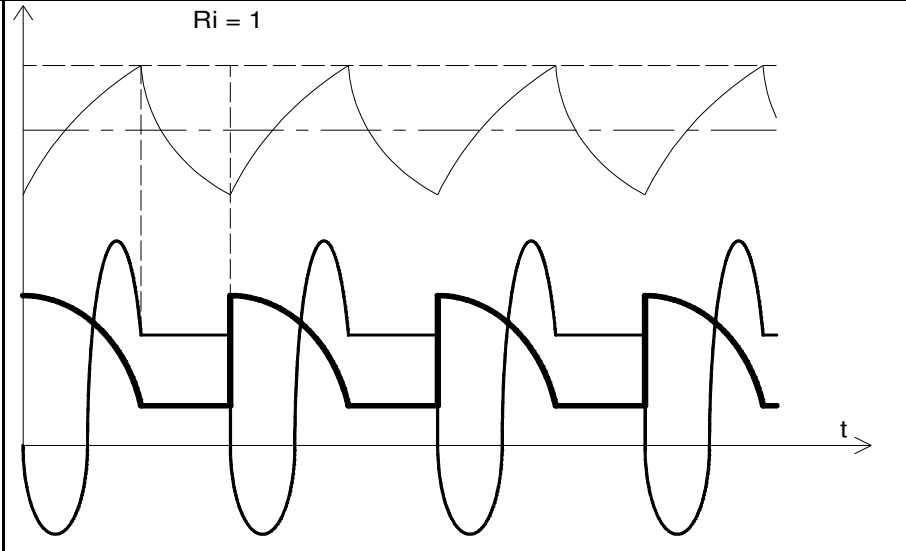

**Servizio ininterrotto periodico con variazioni correlate di carico e velocità S8<sup>(1)</sup>**  
 Sequenza di cicli di funzionamento identici, ciascuno comprendente un tempo di funzionamento a carico costante corrispondente ad una prestabilita velocità di rotazione, seguito da uno o più tempi di funzionamento con altri carichi costanti corrispondenti a diverse velocità di rotazione (realizzato per esempio mediante cambio del numero di poli nel caso dei motori a induzione). Non esiste alcun tempo di riposo. L'abbreviazione appropriata è S8, seguita dal momento d'inerzia del motore e dal momento d'inerzia del carico, entrambi riferiti all'albero del motore, insieme al carico, alla velocità e al rapporto di intermittenza Ri, per ogni regime caratterizzato da una determinata velocità.

**Continuous-operation periodic duty with related load/speed changes S8<sup>(1)</sup>**

A sequence of identical duty cycles, each cycle consisting of a time of operation at constant load corresponding to a predetermined speed of rotation, followed by one or more times of operation at other constant loads corresponding to different speed of rotation (carried out, for example, by means of a change in the number of poles in the case of induction motors). There is no time de-energized and at rest. The appropriate abbreviation is S8, followed by the moment of inertia of the motor and the moment of inertia of the load, both referred to the motor shaft, together with the load, speed and cyclic duration factor Ri for each speed condition.

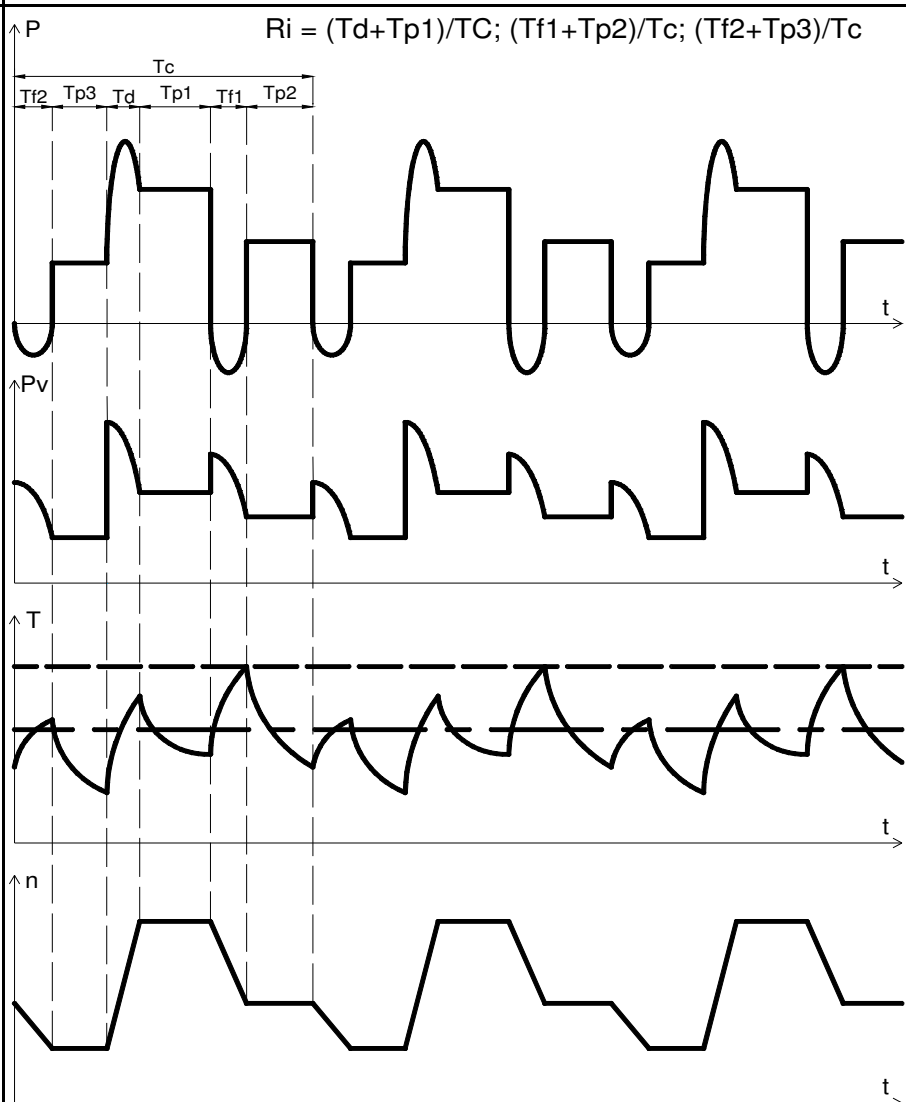

(1) Il servizio periodico implica che l'equilibrio termico non è raggiunto durante il periodo a carico.

(1) Periodic duty implies that thermal equilibrium is not reached during the time on load.



## TIPI DI SERVIZIO E IDENTIFICAZIONE DEL SERVIZIO

Tabella/Tables  
N° 9

## DUTY TYPES AND DECLARATION OF DUTY

Foglio/Sheet  
N° 4

----- Max  
 T: Temperature    - - - - - Average  
 ————— Instantaneous

P: Carico  
load

Pv: Perdite elettriche  
Electrical losses

n: Velocità  
speed

### Servizio con variazioni non periodiche di carico e velocità S9

Servizio in cui generalmente il carico e la velocità variano in modo non periodico nel campo di funzionamento ammissibile. Questo servizio comprende sovraccarichi frequentemente applicati che possono essere largamente superiori ai valori di pieno carico.

L'abbreviazione appropriata è S9. Per questo tipo di servizio si prende come valore di riferimento per il concetto di sovraccarico un carico costante adeguatamente scelto e basato sul tipo di servizio S1.

### Duty with non-periodic load and speed variations S9

A duty in which generally load and speed vary non-periodically within the permissible operating range. This duty includes frequently applied overloads that may greatly exceed the reference load.

The appropriate abbreviation is S9. For this duty type, a constant load appropriately selected and based on duty type S1 is taken as the reference value for the overload concept.

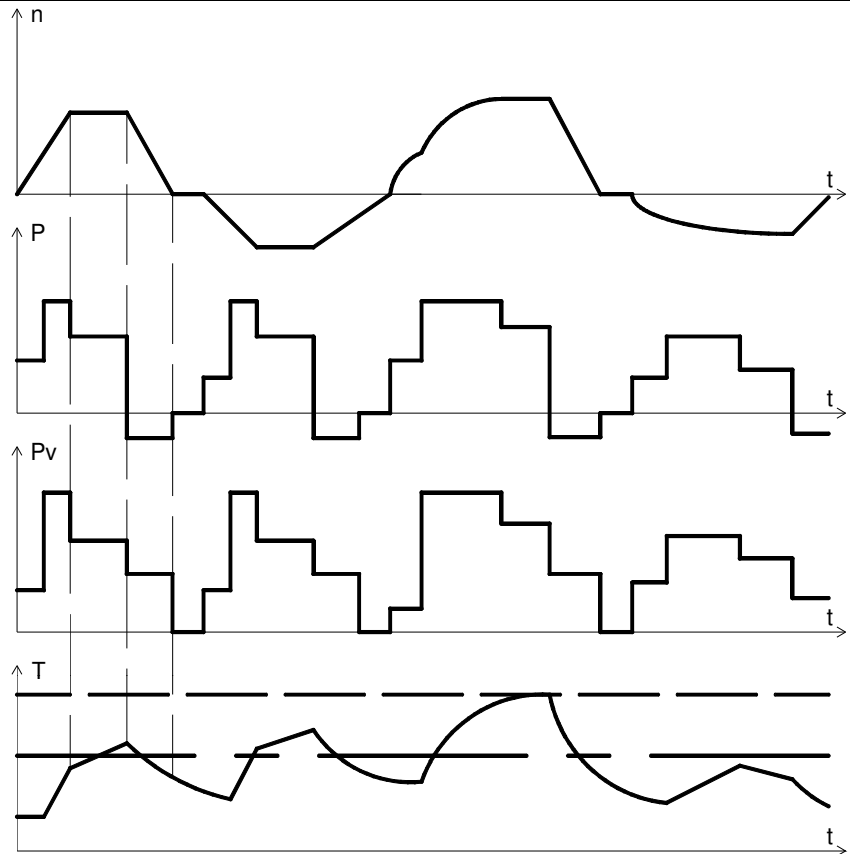

### Servizio con carichi distinti costanti S10

Servizio che consiste in un numero specifico di valori distinti di carico (o carico equivalente), mantenendo ogni valore per un tempo sufficiente per consentire alla macchina di raggiungere l'equilibrio termico. Il carico minimo durante un ciclo di servizio può avere valore zero (a vuoto o in stato di riposo).

L'abbreviazione appropriata è S10. Per questo tipo di servizio, deve essere assunto come valore di riferimento per i carichi distinti un carico costante adeguatamente scelto e basato sul servizio S1.

### Duty with discrete constant loads and speeds S10

A duty consisting of a specific number of discrete values of load (or equivalent loading) and if applicable, speed, each load/speed combination being maintained for sufficient time to allow the machine to reach thermal equilibrium. The minimum load within a duty cycle may have the value zero (no-load or de-energized and at rest).

The appropriate abbreviation is S10. For this duty type a constant load appropriately selected and based on duty type S1 shall be taken as the reference value for the discrete loads.

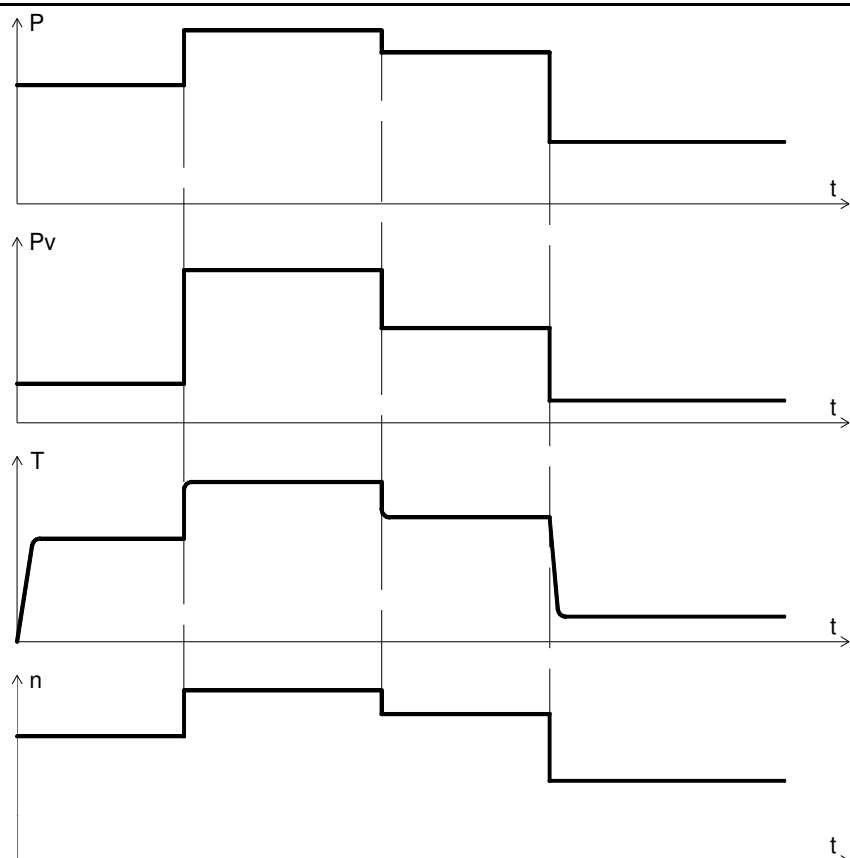



**Motori Serie MGL C  
Motoren Serie MGL C  
Motor Series MGL C**

Tabella / Tisch / Tables  
N° 14 D

Foglio / Seite / Sheet  
N° 1

TIPO TYP TYPE			Momento inerzia Trageistsmoment Moment of inerzia		Eccitazione Erregung Excitation		Dati di Ventilazione Angaben uber die beluftung Ventilation Data			
	PESO GEWICHT WEIGHT	Velocità Drehzahl Speed Max	PD2	J	Costante di tempo Feldzeitconstant Time Constant	Potenza Erregerleistung Power	Potenza Leistung Out Put	Pressione Druck Pressure	Portata Forderstrom Air Flow	
	Kg	giri/1' u/min r.p.m.	Kgm <sup>2</sup>	Kgm <sup>2</sup>	ms	W	50Hz kW	mm H <sub>2</sub> O	m <sup>3</sup> /1'	
160	K	220	4500	0.80	0.20	250	1000	1.1	100	18
	S	238		0.92	0.23	280	1100			
	M	264		1.12	0.28	310	1200			
	L	302		1.36	0.34	340	1300			
	P	320		1.48	0.37	360	1400			
180	K	315	3500	1.84	0.46	300	1300	1.5	115	23
	S	345		2.00	0.50	330	1450			
	M	378		2.28	0.57	360	1600			
	L	420		2.64	0.66	390	1850			
	P	455	3000	2.96	0.74	410	2100			
	X	506		3.32	0.83	430	2400			
200	K	510	3200	3.20	0.80	350	2000	2.2	130	28
	S	560		3.52	0.88	400	2150			
	M	605		4.12	1.03	450	2300			
	L	660		4.80	1.20	490	2500			
	P	700		5.33	1.33	520	2900			
	X	740	2800	5.80	1.45	550	3200			
	X2	770		6.32	1.58	590	3600			
250	K	900	3000	10.40	2.60	430	2100	2.2	120	50
	S	940		11.60	2.90	470	2300			
	M	1080		13.20	3.30	480	2700			
	L	1170		14.80	3.70	510	3100			
	P	1300		16.40	4.10	540	3500			
	X	1350	2700	17.60	4.40	560	3800			
	X2	1460		19.04	4.76	580	4100			
	X4	1580		23.00	5.75	610	4400			
280	S	1195	2600	23.60	5.90	430	2200	4.0	120	70
	M	1350		26.40	6.60	470	2500			
	L	1530		29.20	7.30	490	2800			
	P	1830		33.20	8.30	510	3000			
315	K	1820	2500	30.00	7.50	500	2900	4.0	130	120
	S	1970		34.00	8.50	590	3500			
	M	2150		38.00	9.50	640	4000			
	L	2370		42.00	10.50	730	4500			
	P	2650		48.00	12.00	800	5200			
	X	2740	2300	51.20	12.80	850	5600			
	X2	2930		56.90	14.23	870	5800			
400	K	3150	2200	120.00	30.00	1050	5000	5.0	130	150
	S	3500		132.00	33.00	1150	6000			
	M	3900		146.00	36.50	1220	6600			
	L	4400		162.80	40.70	1300	7400			
	P	5000		180.00	45.00	1400	8300			
	X	5400	2000	196.80	49.20	1500	9500			
500	K	5645	1800	240.00	60.00	1080	4600	9.0	150	170
	S	5930		264.00	66.00	1120	5000			
	M	6300		294.80	73.70	1160	5600			
	L	6720		330.40	82.60	1240	6200			
	P	7220		371.20	92.80	1300	7000			
	X	7700		412.00	103.00	1350	7700			





TABELLA SELEZIONE MOTORI  
MGLC 160 - 180 - 200

DATA: 01/12/2011

Tabella 1





TABELLA SELEZIONE MOTORI  
MGLC 250 -280

DATA: 01/12/2011

Tabella 2

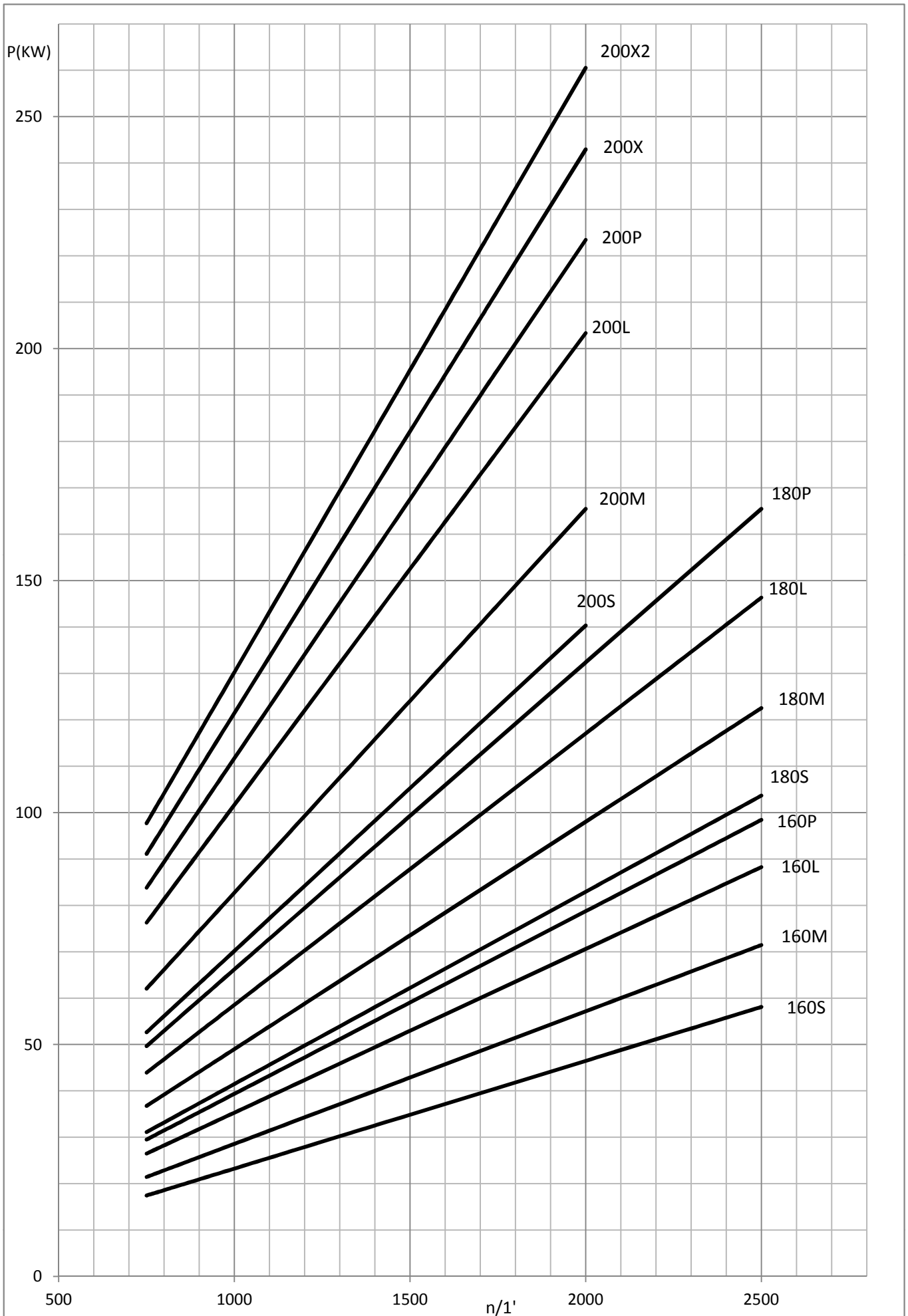



TABELLA SELEZIONE MOTORI  
MGLC 315 - 400 - 500

DATA: 01/12/2011

Tabella 3

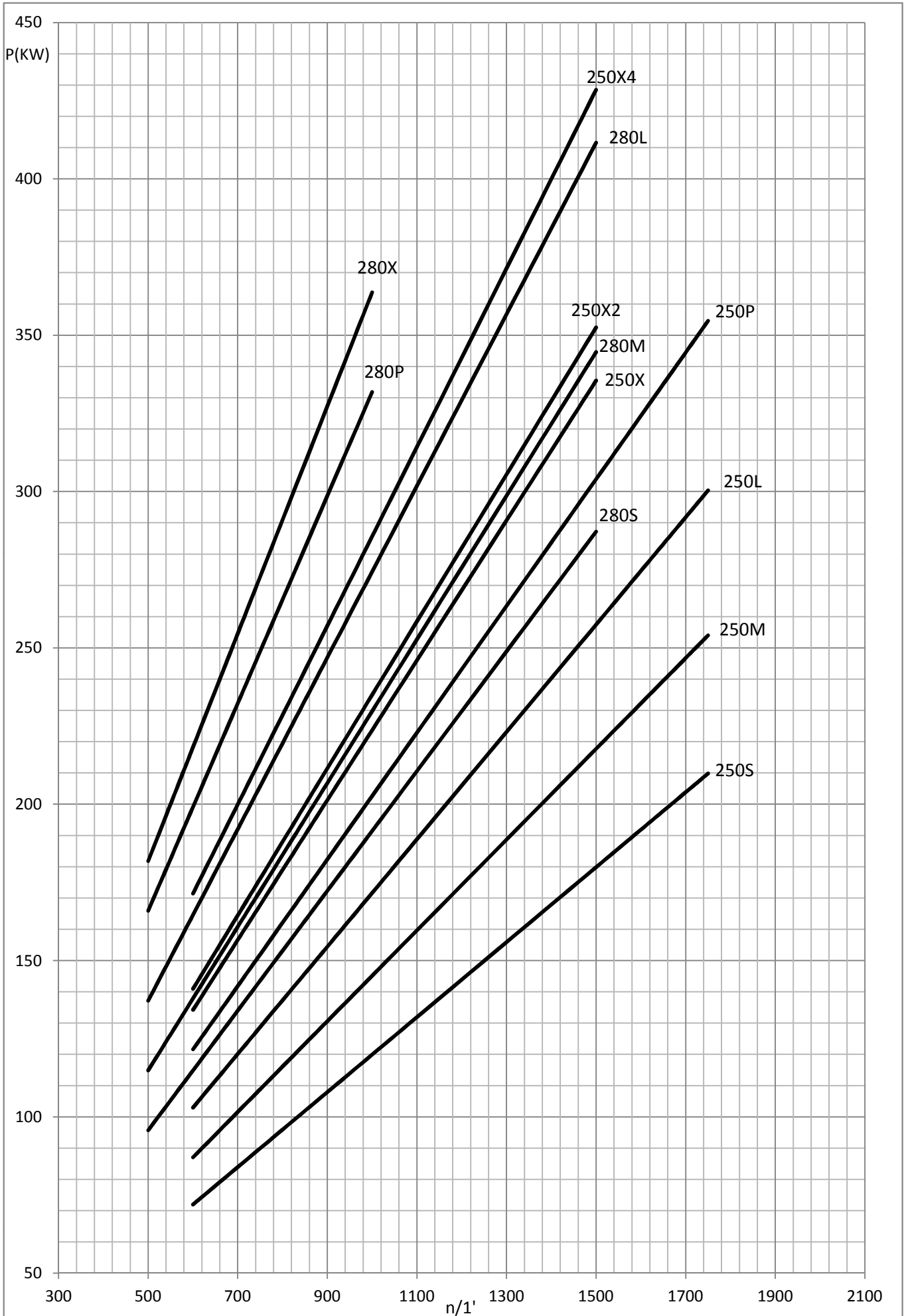
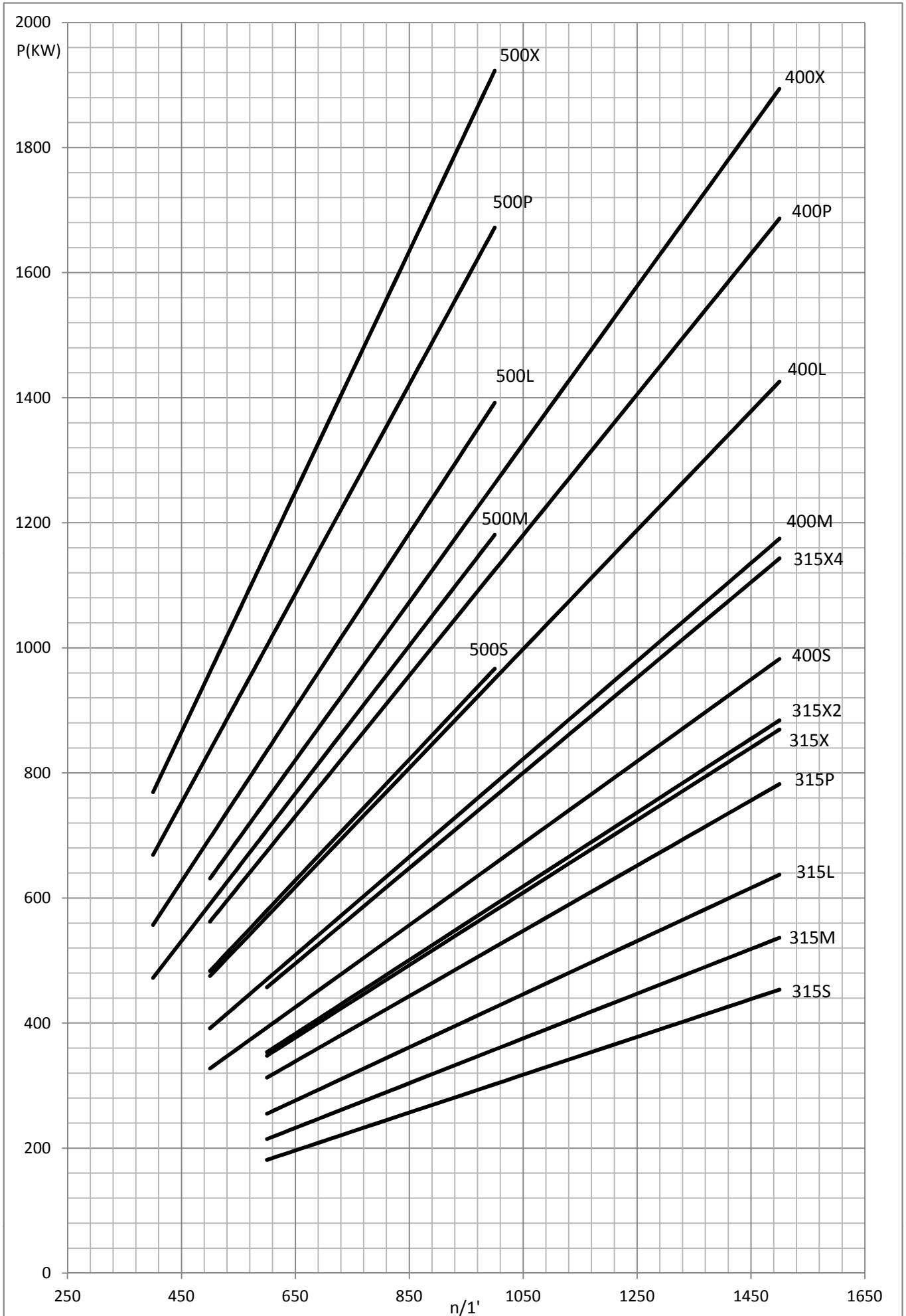



Potenza eccitazione Excitation power (w) 1000	
Cost. tempo eccitaz. Field time constant (ms) 250	
Massa del motore Mass of the motor (Kg) 220	
Momento d'inerzia rotore Rotor inertia moment (Kgm2) 0.20	
Tipo Size MGL C 160 K	
Ventilazione Ventilation IC 06	

Avv.	Velocità nominale n/min a tensione nominale di armatura Rated speed (rev/min) at rated voltage							Potenza Power kW	Coppia vel.nomin. Torque at rated speed Nm	Rendimento Efficiency %	Circuito di armatura Armature circuit			Max giri Max. speed (°)
	220	400	440	460	470	520	600				Corrente Current Amp	Res. 115°C mOhm	Ind. mH	
48	1370	---	---	---	---	---	---	26.2	183	85.1	140	176	0.976	4283
		2640	---	---	---	---	---	50.6	183	90.4	140			4500
		---	2925	---	---	---	---	56.0	183	90.9	140			4500
		---	---	3065	---	---	---	58.5	182	91.5	139			4500
		---	---	---	3140	---	---	59.7	182	91.4	139			4500
		---	---	---	---	---	3490	65.5	179	91.9	137			4500
		---	---	---	---	---	4060	74	175	92.4	134			4500
49	1190	---	---	---	---	---	---	22.9	184	83.3	125	230	1.10	3775
		2325	---	---	---	---	---	44.7	184	89.4	125			4244
		---	2575	---	---	---	---	49.6	184	90.2	125			4299
		---	---	2700	---	---	---	51.8	183	90.8	124			4342
		---	---	---	2765	---	---	52.9	183	90.8	124			4363
		---	---	---	---	---	3080	58.2	180	91.0	123			4465
		---	---	---	---	---	3580	66.4	177	92.2	120			4500
50	1090	---	---	---	---	---	---	21.1	185	82.7	116	261	1.43	4120
		2135	---	---	---	---	---	41.3	185	89.0	116			4500
		---	2365	---	---	---	---	45.8	185	89.7	116			4500
		---	---	2480	---	---	---	47.9	184	89.8	116			4500
		---	---	---	2540	---	---	49.0	184	90.7	115			4500
		---	---	---	---	---	2830	54.0	182	91.1	114			4500
		---	---	---	---	---	3295	61.9	179	92.1	112			4500
51	945	---	---	---	---	---	---	18.5	187	80.9	104	335	1.78	3027
		1870	---	---	---	---	---	36.6	187	88.0	104			3415
		---	2075	---	---	---	---	40.7	187	88.9	104			3460
		---	---	2180	---	---	---	42.6	187	89.0	104			3491
		---	---	---	2230	---	---	43.5	186	89.9	103			3506
		---	---	---	---	---	2485	48.1	185	89.8	103			3577
		---	---	---	---	---	2900	55.3	182	91.3	101			3682
52	875	---	---	---	---	---	---	17.0	186	79.7	97	384	1.97	3395
		1745	---	---	---	---	---	33.9	186	87.4	97			3832
		---	1935	---	---	---	---	37.7	186	88.3	97			3882
		---	---	2035	---	---	---	39.5	185	88.8	96.7			3916
		---	---	---	2080	---	---	40.3	185	88.8	96.6			3932
		---	---	---	---	---	2325	44.7	184	89.7	95.8			4009
		---	---	---	---	---	2710	51.5	182	90.8	94.5			4122
53	770	---	---	---	---	---	---	15.1	187	78.0	88	465	2.48	2541
		1555	---	---	---	---	---	30.5	187	86.6	88			2883
		---	1730	---	---	---	---	33.9	187	87.6	88			2922
		---	---	1815	---	---	---	35.5	187	87.9	87.8			2947
		---	---	---	1860	---	---	36.3	186	88.2	87.6			2959
		---	---	---	---	---	2080	40.3	185	89.1	87			3015
		---	---	---	---	---	2425	46.5	183	90.1	86			3097
54	720	---	---	---	---	---	---	13.8	183	76.5	82	544	2.57	2913
		1465	---	---	---	---	---	28.1	183	85.7	82			3316
		---	1630	---	---	---	---	31.3	183	86.8	82			3361
		---	---	1715	---	---	---	32.8	183	87.2	81.8			3389
		---	---	---	---	---	---	33.5	182	87.2	81.7			3403
		---	---	---	---	---	1960	37.3	182	88.3	81.2			3466
		---	---	---	---	---	---	---	---	---	---			---

Nota (\*) - VENTILAZIONE SOLO L.O. / FAN ONLY SIDE COMMUTATOR

Nota (°) - Regolazione di campo / Field weakening



Potenza eccitazione Excitation power	(w)	1000	Tipo Size MGL C 160 K Ventilazione Ventilation IC 06
Cost. tempo eccitaz. Field time constant	(ms)	250	
Massa del motore Mass of the motor	(Kg)	220	
Momento d'inerzia rotore Rotor inertia moment	(Kgm2)	0.20	

Avv.	Velocità nominale n/min a tensione nominale di armatura Rated speed (rev/min) at rated voltage							Potenza Power kW	Coppia vel.nomin. Torque at rated speed Nm	Rendimento Efficiency %	Circuito di armatura Armature circuit			Max giri Max. speed (°)				
	220	400	440	460	470	520	600				Corrente Current Amp	Res. 115°C mOhm	Ind. mH					
55	610	---	---	---	---	---	---	11.8	185	74.0	72.5	688	3.59	2510				
		1260	---	---	---	---	---	24.5	186	84.5	72.5			2869				
		---	1405	---	---	---	---	27.3	186	85.6	72.5			2909				
		---	---	1480	---	---	---	28.6	185	85.9	72.4			2933				
		---	---	---	1515	---	---	29.3	185	86.2	72.3			2944				
		---	---	---	---	1695	---	32.7	184	87.5	71.9			2996				
		---	---	---	---	---	1985	37.9	182	88.6	71.3			3069				
		56	525	---	---	---	---	---	---	10.1	184			71.7	64	858	4.66	2226
1105	---			---	---	---	---	21.3	184	83.2	64	2561						
---	1235			---	---	---	---	23.8	184	84.5	64	2598						
---	---			1300	---	---	---	25.0	184	85.1	63.9	2618						
---	---			---	1330	---	---	25.6	184	85.4	63.8	2628						
---	---			---	---	1490	---	28.6	183	86.6	63.5	2674						
---	---			---	---	---	1750	33.3	182	88.1	63	2737						
57	450			---	---	---	---	---	---	8.77	186	68.7	58	1070	5.77			1970
		975	---	---	---	---	---	18.9	185	81.5	58	2284						
		---	1090	---	---	---	---	21.2	186	83.1	58	2318						
		---	---	1150	---	---	---	22.3	185	83.7	57.9	2337						
		---	---	---	1175	---	---	22.8	185	83.8	57.9	2345						
		---	---	---	---	1320	---	25.5	185	85.1	57.6	2385						
		---	---	---	---	---	1555	29.8	183	86.7	57.3	2440						
		58	395	---	---	---	---	---	---	7.54	182	65.9	52			1320	6.82	1789
870	---			---	---	---	---	16.6	182	79.8	52	2096						
---	975			---	---	---	---	18.6	182	81.3	52	2129						
---	---			1025	---	---	---	19.6	183	82.1	51.9	2146						
---	---			---	1055	---	---	20.1	182	82.4	51.9	2154						
---	---			---	---	1185	---	22.6	182	84.1	51.7	2191						
---	---			---	---	---	1395	26.4	181	85.6	51.4	2240						
59	780			---	---	---	---	---	---	15.0	184	78.1	48	1580	7.81			1904
		875	---	---	---	---	---	16.9	184	80.0	48	1935						
		---	925	---	---	---	---	17.8	184	80.8	47.9	1950						
		---	---	950	---	---	---	18.3	184	81.3	47.9	1958						
		---	---	---	1070	---	---	20.5	183	82.5	47.8	1991						
		---	---	---	---	1260	---	24.1	183	84.6	47.5	2036						
		60	705	---	---	---	---	---	---	13.9	188	77.2	45			1800	9.21	1730
				795	---	---	---	---	---	15.6	187	78.8	45					1759
---	840			---	---	---	---	16.5	188	79.7	45	1773						
---	---			865	---	---	---	16.9	187	80.1	44.9	1779						
---	---			---	975	---	---	19.0	186	81.6	44.8	1809						
---	---			---	---	1155	---	22.4	185	83.7	44.6	1849						
61	640			---	---	---	---	---	---	12.5	187	75.3	41.5	2130	10.4			1610
				725	---	---	---	---	---	14.1	186	77.2	41.5					1638
		---	765	---	---	---	---	14.9	186	78.1	41.5	1652						
		---	---	785	---	---	---	15.3	186	78.6	41.4	1658						
		---	---	---	890	---	---	17.3	186	80.6	41.3	1686						
		---	---	---	---	1055	---	20.4	185	82.5	41.2	1724						

Nota (\*) - VENTILAZIONE SOLO L.O. / FAN ONLY SIDE COMMUTATOR

Nota (°) - Regolazione di campo / Field weakening



Potenza eccitazione Excitation power (w)	1000	Tipo Size MGL C 160 K Ventilazione Ventilation IC 06
Cost. tempo eccitaz. Field time constant (ms)	250	
Massa del motore Mass of the motor (Kg)	220	
Momento d'inerzia rotore Rotor inertia moment (Kgm2)	0.20	

Avv.	Velocità nominale n/min a tensione nominale di armatura Rated speed (rev/min) at rated voltage							Potenza Power kW	Coppia vel.nomin. Torque at rated speed Nm	Rendimento Efficiency %	Circuito di armatura Armature circuit			Max giri Max. speed (°)
	220	400	440	460	470	520	600				Corrente Current Amp	Res. 115°C mOhm	Ind. mH	
62		590	---	---	---	---	---	11.5	186	74.3	38.7	2390	13.6	1501
			670	---	---	---	---	13.0	185	76.3	38.7			
				705	---	---	---	13.7	186	77.0	38.7			
					725	---	---	14.1	186	77.7	38.6			
						825	---	16.0	185	79.7	38.6			
							975	18.9	185	82.0	38.4			
63		540	---	---	---	---	---	10.6	187	72.6	36.5	2710	14.6	1396
			615	---	---	---	---	12.0	186	74.7	36.5			
				650	---	---	---	12.7	187	75.6	36.5			
					670	---	---	13.1	187	76.4	36.5			
						760	---	14.8	186	78.2	36.4			
							905	17.6	186	80.8	36.3			
64		500	---	---	---	---	---	9.66	185	71.0	34	3100	16.5	1321
			565	---	---	---	---	11.0	186	73.5	34			
				600	---	---	---	11.6	185	74.2	34			
					620	---	---	12.0	185	75.1	34			
						705	---	13.6	184	77.1	33.9			
							840	16.2	184	79.9	33.8			
65		455	---	---	---	---	---	8.83	185	69.0	32	3570	18.2	1245
			520	---	---	---	---	10.1	186	71.7	32			
				555	---	---	---	10.7	184	72.7	32			
					570	---	---	11.0	184	73.1	32			
						650	---	12.5	184	75.4	31.9			
							780	15.0	184	78.6	31.8			

Nota (\*) - VENTILAZIONE SOLO L.O. / FAN ONLY SIDE COMMUTATOR

Nota (°) - Regolazione di campo / Field weakening



Potenza eccitazione Excitation power (w) 1100	
Cost. tempo eccitaz. Field time constant (ms) 280	
Massa del motore Mass of the motor (Kg) 238	
Momento d'inerzia rotore Rotor inertia moment (Kgm2) 0.23	
Tipo Size MGL C 160 S	
Ventilazione Ventilation IC 06	

Avv.	Velocità nominale n/min a tensione nominale di armatura Rated speed (rev/min) at rated voltage							Potenza Power kW	Coppia vel.nomin. Torque at rated speed Nm	Rendimento Efficiency %	Circuito di armatura Armature circuit			Max giri Max. speed (°)
	220	400	440	460	470	520	600				Corrente Current Amp	Res. 115°C mOhm	Ind. mH	
47	1310	---	---	---	---	---	---	30.2	220	85.8	160	147	0.905	4296
		2525	---	---	---	---	---	58.2	220	90.9	160			
		---	2795	---	---	---	---	64.5	220	91.6	160			
		---	---	2930	---	---	---	67.2	219	91.9	159			
		---	---	---	2995	---	---	68.6	219	91.8	159			
		---	---	---	---	3335	---	75.2	215	92.7	156			
48	1125	---	---	---	---	---	---	26.0	221	84.4	140	192	1.16	3743
		2190	---	---	---	---	---	50.5	220	90.2	140			
		---	2425	---	---	---	---	56.0	221	90.9	140			
		---	---	2540	---	---	---	58.5	220	91.5	139			
		---	---	---	2600	---	---	59.7	219	91.4	139			
		---	---	---	---	2895	---	65.7	217	92.2	137			
		---	---	---	---	---	3370	74.8	212	92.3	135			
49	980	---	---	---	---	---	---	22.7	221	82.5	125	250	1.30	3297
		1920	---	---	---	---	---	44.6	222	89.2	125			
		---	2130	---	---	---	---	49.5	222	90.0	125			
		---	---	2235	---	---	---	51.7	221	89.9	125			
		---	---	---	2290	---	---	52.8	220	90.6	124			
		---	---	---	---	2550	---	58.3	218	91.2	123			
50	895	---	---	---	---	---	---	20.9	223	81.9	116	284	1.70	3599
		1765	---	---	---	---	---	41.2	223	88.8	116			
		---	1955	---	---	---	---	45.7	223	89.5	116			
		---	---	2055	---	---	---	47.8	222	89.6	116			
		---	---	---	2105	---	---	48.9	222	90.5	115			
		---	---	---	---	2345	---	54.1	220	91.3	114			
51	770	---	---	---	---	---	---	18.2	226	79.5	104	365	2.11	2640
		1545	---	---	---	---	---	36.5	226	87.7	104			
		---	1715	---	---	---	---	40.5	226	88.5	104			
		---	---	1800	---	---	---	42.4	225	88.6	104			
		---	---	---	1845	---	---	43.4	225	88.8	104			
		---	---	---	---	2060	---	48.1	223	89.8	103			
52	715	---	---	---	---	---	---	16.7	223	78.3	97	419	2.34	2961
		1440	---	---	---	---	---	33.8	224	87.1	97			
		---	1600	---	---	---	---	37.5	224	87.9	97			
		---	---	1680	---	---	---	39.3	223	88.4	96.7			
		---	---	---	1720	---	---	40.2	223	88.5	96.6			
		---	---	---	---	1920	---	44.6	222	89.3	96			
53	630	---	---	---	---	---	---	14.9	226	77.0	88	507	2.95	2213
		1280	---	---	---	---	---	30.3	226	86.1	88			
		---	1425	---	---	---	---	33.7	226	87.0	88			
		---	---	1500	---	---	---	35.4	225	87.6	87.8			
		---	---	---	1535	---	---	36.2	225	87.8	87.7			
		---	---	---	---	1720	---	40.2	223	88.7	87.2			
					2010	46.5	221	89.8	86.3					

Nota (\*) - VENTILAZIONE SOLO L.O. / FAN ONLY SIDE COMMUTATOR

Nota (°) - Regolazione di campo / Field weakening





Potenza eccitazione		
Excitation power	(w)	1100
Cost. tempo eccitaz.		
Field time constant	(ms)	280
Massa del motore		
Mass of the motor	(Kg)	238
Momento d'inerzia rotore		
Rotor inertia moment	(Kgm2)	0.23

Tipo		
Size	MGL C 160	S
Ventilazione		
Ventilation		IC 06

Avv.	Velocità nominale n/min a tensione nominale di armatura Rated speed (rev/min) at rated voltage							Potenza Power kW	Coppia vel.nomin. Torque at rated speed Nm	Rendimento Efficiency %	Circuito di armatura Armature circuit			Max giri Max. speed (°)
	220	400	440	460	470	520	600				Corrente Current Amp	Res. 115°C mOhm	Ind. mH	
54	585	---	---	---	---	---	---	13.5	220	74.8	82	593	3.05	2535
		1205	---	---	---	---	---	27.9	221	85.1	82			
		---	1345	---	---	---	---	31.1	221	86.2	82			
		---	---	1415	---	---	---	32.6	220	86.6	81.8			
		---	---	---	1450	---	---	33.4	220	87.0	81.7			
		---	---	---	---	1620	---	37.2	219	88.0	81.3			
		---	---	---	---	---	---	---	---	---	---			
55	495	---	---	---	---	---	---	11.5	222	72.1	72.5	751	4.26	2181
		1040	---	---	---	---	---	24.3	223	83.8	72.5			
		---	1160	---	---	---	---	27.1	223	85.0	72.5			
		---	---	1220	---	---	---	28.5	223	85.6	72.4			
		---	---	---	1250	---	---	29.1	222	85.6	72.3			
		---	---	---	---	1400	---	32.5	222	86.8	72			
		---	---	---	---	---	1640	37.9	221	88.5	71.4			
56	425	---	---	---	---	---	---	9.85	221	70.0	64	936	5.54	1931
		910	---	---	---	---	---	21.1	221	82.4	64			
		---	1015	---	---	---	---	23.6	222	83.8	64			
		---	---	1070	---	---	---	24.8	221	84.4	63.9			
		---	---	---	1095	---	---	25.4	222	84.7	63.8			
		---	---	---	---	1230	---	28.4	221	85.9	63.6			
		---	---	---	---	---	1445	33.1	219	87.3	63.2			
57	365	---	---	---	---	---	---	8.49	222	66.5	58	1170	6.85	1706
		800	---	---	---	---	---	18.7	223	80.6	58			
		---	895	---	---	---	---	20.9	223	81.9	58			
		---	---	945	---	---	---	22.0	222	82.6	57.9			
		---	---	---	965	---	---	22.6	224	83.0	57.9			
		---	---	---	---	1090	---	25.3	222	84.3	57.7			
		---	---	---	---	---	1280	29.7	222	86.4	57.3			
58	710	---	---	---	---	---	---	16.4	221	78.8	52	1440	8.10	1841
		800	---	---	---	---	---	18.4	220	80.4	52			
		---	---	840	---	---	---	19.4	221	81.3	51.9			
		---	---	---	865	---	---	19.9	220	81.6	51.9			
		---	---	---	---	975	---	22.4	219	83.3	51.7			
		---	---	---	---	---	1150	26.3	218	85.1	51.5			
		---	---	---	---	---	---	---	---	---	---			
59	635	---	---	---	---	---	---	14.8	223	77.1	48	1720	9.27	1672
		715	---	---	---	---	---	16.6	222	78.6	48			
		---	755	---	---	---	---	17.6	223	79.9	47.9			
		---	---	775	---	---	---	18.0	222	80.0	47.9			
		---	---	---	875	---	---	20.3	222	81.7	47.8			
		---	---	---	---	1040	---	23.9	220	83.7	47.6			
		---	---	---	---	---	---	---	---	---	---			
60	575	---	---	---	---	---	---	13.6	226	75.6	45	1960	10.9	1519
		650	---	---	---	---	---	15.4	226	77.8	45			
		---	685	---	---	---	---	16.2	226	78.3	45			
		---	---	705	---	---	---	16.7	226	79.1	44.9			
		---	---	---	800	---	---	18.8	224	80.7	44.8			
		---	---	---	---	950	---	22.2	223	83.0	44.6			
		---	---	---	---	---	---	---	---	---	---			

Nota (\*) - VENTILAZIONE SOLO L.O. / FAN ONLY SIDE COMMUTATOR

Nota (°) - Regolazione di campo / Field weakening



Potenza eccitazione Excitation power	(w)	1100	Tipo Size Ventilazione Ventilation	MGL C 160 S  IC 06
Cost. tempo eccitaz. Field time constant	(ms)	280		
Massa del motore Mass of the motor	(Kg)	238		
Momento d'inerzia rotore Rotor inertia moment	(Kgm2)	0.23		

Avv.	Velocità nominale n/min a tensione nominale di armatura Rated speed (rev/min) at rated voltage							Potenza Power kW	Coppia vel.nomin. Torque at rated speed Nm	Rendimento Efficiency %	Circuito di armatura Armature circuit			Max giri Max. speed (°)
	220	400	440	460	470	520	600				Corrente Current Amp	Res. 115°C mOhm	Ind. mH	
61		520	---	---	---	---	---	12.2	224	73.5	41.5	2320	12.3	1413
			590	---	---	---	---	13.8	223	75.6	41.5			1440
				625	---	---	---	14.6	223	76.5	41.5			1452
					640	---	---	15.0	224	77.1	41.4			1458
						730	---	17.0	222	79.0	41.4			1485
							865	20.2	223	81.7	41.2			1520
62		480	---	---	---	---	---	11.2	223	72.4	38.7	2610	16.2	1316
			545	---	---	---	---	12.7	223	74.6	38.7			1342
				575	---	---	---	13.5	224	75.8	38.7			1354
					590	---	---	13.8	223	75.9	38.7			1360
						670	---	15.7	224	78.2	38.6			1385
							800	18.7	223	81.2	38.4			1417
63		440	---	---	---	---	---	10.3	224	70.5	36.5	2960	17.3	1223
			500	---	---	---	---	11.8	225	73.5	36.5			1248
				530	---	---	---	12.4	223	73.9	36.5			1259
					545	---	---	12.8	224	74.6	36.5			1265
						620	---	14.6	225	77.1	36.4			1288
							740	17.4	225	79.9	36.3			1319
64		400	---	---	---	---	---	9.38	224	69.0	34	3390	19.6	1156
			460	---	---	---	---	10.7	222	71.5	34			1181
				485	---	---	---	11.4	225	72.9	34			1192
					500	---	---	11.7	224	73.2	34			1198
						575	---	13.3	221	75.4	33.9			1221
							685	15.9	222	78.4	33.8			1250
65		365	---	---	---	---	---	8.53	223	66.6	32	3760	23.8	989
			420	---	---	---	---	9.78	222	69.5	32			1013
				450	---	---	---	10.4	221	70.7	32			1024
					460	---	---	10.7	222	71.1	32			1029
						530	---	12.3	222	74.1	31.9			1051
							635	14.7	221	77.0	31.8			1078

Nota (\*) - VENTILAZIONE SOLO L.O. / FAN ONLY SIDE COMMUTATOR

Nota (°) - Regolazione di campo / Field weakening



Potenza eccitazione Excitation power (w) 1200	
Cost. tempo eccitaz. Field time constant (ms) 310	
Massa del motore Mass of the motor (Kg) 264	
Momento d'inerzia rotore Rotor inertia moment (Kgm2) 0.28	
Tipo Size MGL C 160 M	
Ventilazione Ventilation IC 06	

Avv.	Velocità nominale n/min a tensione nominale di armatura Rated speed (rev/min) at rated voltage							Potenza Power kW	Coppia vel.nomin. Torque at rated speed Nm	Rendimento Efficiency %	Circuito di armatura Armature circuit			Max giri Max. speed (°)	
	220	400	440	460	470	520	600				Corrente Current Amp	Res. 115°C mOhm	Ind. mH		
46	1265	---	---	---	---	---	---	35.2	266	87.0	184	118	0.739	4360	*
		2420	---	---	---	---	---	67.5	266	91.7	184			4500	
		---	2680	---	---	---	---	74.7	266	92.3	184			4500	
		---	---	2805	---	---	---	78.2	266	92.4	184			4500	
		---	---	---	2870	---	---	80.0	266	92.5	184			4500	
		---	---	---	---	3195	---	89.0	266	93.0	184			4500	
		---	---	---	---	---	3710	103	265	93.3	184			4500	
47	1060	---	---	---	---	---	---	30.0	270	85.2	160	163	1.10	3676	
		2050	---	---	---	---	---	58.1	271	90.8	160			4178	
		---	2270	---	---	---	---	64.3	271	91.3	160			4238	
		---	---	2380	---	---	---	67.1	269	91.7	159			4284	
		---	---	---	2435	---	---	68.5	269	91.7	159			4306	
		---	---	---	---	2715	---	75.4	265	92.4	157			4416	
		---	---	---	---	---	---	---	---	---	---			---	
48	905	---	---	---	---	---	---	25.7	271	83.4	140	214	1.40	3200	
		1775	---	---	---	---	---	50.3	271	89.8	140			3650	
		---	1970	---	---	---	---	55.8	271	90.6	140			3703	
		---	---	2065	---	---	---	58.3	270	91.2	139			3741	
		---	---	---	2115	---	---	59.6	269	91.2	139			3760	
		---	---	---	---	2355	---	65.7	266	91.6	138			3849	
		---	---	---	---	---	2740	75.2	262	92.8	135			3983	
49	785	---	---	---	---	---	---	22.4	273	81.5	125	278	1.58	2817	
		1560	---	---	---	---	---	44.4	272	88.8	125			3226	
		---	1730	---	---	---	---	49.3	272	89.6	125			3274	
		---	---	1815	---	---	---	51.5	271	89.6	125			3306	
		---	---	---	1860	---	---	52.7	271	90.4	124			3322	
		---	---	---	---	2075	---	58.3	268	91.2	123			3395	
		---	---	---	---	---	2415	66.9	265	92.1	121			3504	
50	715	---	---	---	---	---	---	20.6	275	80.7	116	315	2.05	3074	
		1430	---	---	---	---	---	41.0	274	88.4	116			3516	
		---	1585	---	---	---	---	45.5	274	89.1	116			3567	
		---	---	1665	---	---	---	47.7	274	89.4	116			3600	
		---	---	---	1705	---	---	48.7	273	89.3	116			3616	
		---	---	---	---	1905	---	54.0	271	90.3	115			3690	
		---	---	---	---	---	2220	62.2	268	91.7	113			3798	
51	615	---	---	---	---	---	---	17.9	278	78.2	104	406	2.55	2252	
		1250	---	---	---	---	---	36.2	277	87.0	104			2594	
		---	1390	---	---	---	---	40.2	276	87.8	104			2633	
		---	---	1460	---	---	---	42.2	276	88.2	104			2657	
		---	---	---	1495	---	---	43.1	275	88.2	104			2669	
		---	---	---	---	1670	---	47.9	274	89.4	103			2722	
		---	---	---	---	---	1950	55.4	271	90.5	102			2799	
52	570	---	---	---	---	---	---	16.4	275	76.9	97	466	2.83	2523	
		1160	---	---	---	---	---	33.5	276	86.3	97			2911	
		---	1295	---	---	---	---	37.2	274	87.2	97			2955	
		---	---	1360	---	---	---	39.1	275	87.8	96.8			2981	
		---	---	---	1395	---	---	40.0	274	88.0	96.7			2994	
		---	---	---	---	1560	---	44.5	272	89.0	96.1			3052	
		---	---	---	---	---	1820	51.5	270	90.3	95.1			3135	

Nota (\*) - VENTILAZIONE SOLO L.O. / FAN ONLY SIDE COMMUTATOR

Nota (°) - Regolazione di campo / Field weakening



Potenza eccitazione Excitation power	(w)	1200	Tipo Size Ventilazione Ventilation	MGL C 160 M  IC 06
Cost. tempo eccitaz. Field time constant	(ms)	310		
Massa del motore Mass of the motor	(Kg)	264		
Momento d'inerzia rotore Rotor inertia moment	(Kgm2)	0.28		

Avv.	Velocità nominale n/min a tensione nominale di armatura Rated speed (rev/min) at rated voltage							Potenza Power kW	Coppia vel.nomin. Torque at rated speed Nm	Rendimento Efficiency %	Circuito di armatura Armature circuit			Max giri Max. speed (°)	
	220	400	440	460	470	520	600				Corrente Current Amp	Res. 115°C mOhm	Ind. mH		
53	500	1035	---	---	---	---	---	14.5	277	74.9	88	564	3.57	1884	
			---	---	---	---	---	---	30.0	277	85.2			88	2188
			---	---	---	---	---	---	33.4	276	86.3			88	2223
			---	---	---	---	---	---	35.1	276	86.9			87.8	2242
			---	---	---	---	---	---	35.9	277	87.1			87.7	2252
			---	---	---	---	---	---	40.0	275	88.1			87.3	2295
			---	---	---	---	---	---	46.4	272	89.4			86.5	2356
54	465	970	---	---	---	---	---	13.1	269	72.6	82	659	3.69	2154	
			---	---	---	---	---	---	27.6	272	84.1			82	2515
			---	---	---	---	---	---	30.8	271	85.4			82	2555
			---	---	---	---	---	---	32.3	271	85.8			81.8	2578
			---	---	---	---	---	---	33.1	270	86.1			81.8	2589
			---	---	---	---	---	---	36.9	269	87.2			81.4	2638
			---	---	---	---	---	---	---	---	---			---	---
55	390	835	---	---	---	---	---	11.2	274	70.2	72.5	835	5.16	1850	
			---	---	---	---	---	---	23.9	273	82.4			72.5	2175
			---	---	---	---	---	---	26.8	274	84.0			72.5	2211
			---	---	---	---	---	---	28.1	274	84.4			72.4	2230
			---	---	---	---	---	---	28.8	274	84.8			72.3	2239
			---	---	---	---	---	---	32.3	273	86.3			72.0	2281
			---	---	---	---	---	---	37.7	271	87.8			71.6	2337
56	330	730	---	---	---	---	---	9.47	274	67.3	64	1040	6.71	1634	
			---	---	---	---	---	---	20.7	271	80.9			64	1939
			---	---	---	---	---	---	23.2	272	82.4			64	1972
			---	---	---	---	---	---	24.5	272	83.4			63.9	1990
			---	---	---	---	---	---	25.1	272	83.6			63.9	1998
			---	---	---	---	---	---	28.1	271	85.0			63.6	2035
			---	---	---	---	---	---	32.9	270	86.6			63.3	2084
57	640	715	---	---	---	---	---	18.3	273	78.9	58	1300	8.30	1728	
			---	---	---	---	---	---	20.6	275	80.7			58	1759
			---	---	---	---	---	---	21.7	275	81.5			57.9	1774
			---	---	---	---	---	---	22.2	274	81.6			57.9	1781
			---	---	---	---	---	---	25.0	273	83.3			57.7	1814
			---	---	---	---	---	---	29.4	271	85.4			57.4	1858
			---	---	---	---	---	---	---	---	---			---	---
58	565	640	---	---	---	---	---	16.0	270	76.9	52	1600	9.80	1583	
			---	---	---	---	---	---	18.0	269	78.7			52	1613
			---	---	---	---	---	---	19.0	269	79.6			51.9	1627
			---	---	---	---	---	---	18.5	256	75.8			51.9	1634
			---	---	---	---	---	---	22.0	269	81.7			51.8	1665
			---	---	---	---	---	---	26.0	268	84.1			51.5	1706
			---	---	---	---	---	---	---	---	---			---	---
59	505	570	---	---	---	---	---	14.4	272	75.0	48	1910	11.2	1436	
			---	---	---	---	---	---	16.3	273	77.2			48	1464
			---	---	---	---	---	---	17.2	272	77.9			48	1478
			---	---	---	---	---	---	17.7	273	78.6			47.9	1484
			---	---	---	---	---	---	20.0	273	80.5			47.8	1513
			---	---	---	---	---	---	23.6	270	82.6			47.6	1550
			---	---	---	---	---	---	---	---	---			---	---

Nota (\*) - VENTILAZIONE SOLO L.O. / FAN ONLY SIDE COMMUTATOR

Nota (°) - Regolazione di campo / Field weakening



Potenza eccitazione Excitation power	(w)	1200	Tipo Size Ventilazione Ventilation	MGL C 160 M  IC 06
Cost. tempo eccitaz. Field time constant	(ms)	310		
Massa del motore Mass of the motor	(Kg)	264		
Momento d'inerzia rotore Rotor inertia moment	(Kgm2)	0.28		

Avv.	Velocità nominale n/min a tensione nominale di armatura Rated speed (rev/min) at rated voltage							Potenza Power kW	Coppia vel.nomin. Torque at rated speed Nm	Rendimento Efficiency %	Circuito di armatura Armature circuit			Max giri Max. speed (°)
	220	400	440	460	470	520	600				Corrente Current Amp	Res. 115°C mOhm	Ind. mH	
60		455	---	---	---	---	---	13.2	277	73.3	45	2180	13.2	1304
			515	---	---	---	---	15.0	278	75.8	45			1330
				550	---	---	---	15.9	276	76.8	45			1343
					565	---	---	16.3	276	77.2	44.9			1348
						640	---	18.5	276	79.2	44.9			1374
							760	21.9	275	81.7	44.7			1408
61		410	---	---	---	---	---	11.8	275	71.1	41.5	2580	14.9	1211
			465	---	---	---	---	13.4	275	73.4	41.5			1237
				495	---	---	---	14.2	274	74.4	41.5			1249
					510	---	---	14.6	273	74.9	41.5			1255
						580	---	16.7	275	77.6	41.4			1280
							695	19.9	273	80.5	41.2			1312
62		375	---	---	---	---	---	10.8	275	69.8	38.7	2900	19.6	1128
			430	---	---	---	---	12.3	273	72.2	38.7			1153
				455	---	---	---	13.1	275	73.6	38.7			1164
					470	---	---	13.5	274	74.2	38.7			1169
						535	---	15.3	273	76.2	38.6			1193
							640	18.3	273	79.2	38.5			1223
63		345	---	---	---	---	---	9.93	275	68.0	36.5	3300	20.9	1047
			395	---	---	---	---	11.4	276	71.0	36.5			1071
				415	---	---	---	12.1	278	72.1	36.5			1082
					430	---	---	12.4	275	72.3	36.5			1087
						490	---	14.2	277	75.0	36.4			1110
							590	17.0	275	78.1	36.3			1138
64		315	---	---	---	---	---	8.99	273	66.1	34	3760	23.8	989
			360	---	---	---	---	10.3	273	68.9	34			1013
				385	---	---	---	11.0	273	70.3	34			1024
					395	---	---	11.3	273	70.7	34			1029
						455	---	13.0	273	73.7	33.9			1051
							545	15.6	273	76.9	33.8			1078
65			330	---	---	---	---	9.38	271	66.6	32	4330	26.2	954
				350	---	---	---	10.0	273	67.9	32			964
					360	---	---	10.3	273	68.5	32			969
						415	---	11.9	274	71.7	31.9			991
							505	14.3	270	74.7	31.9			1018

Nota (\*) - VENTILAZIONE SOLO L.O. / FAN ONLY SIDE COMMUTATOR

Nota (°) - Regolazione di campo / Field weakening



Potenza eccitazione Excitation power	(w)	1300	Tipo Size MGL C 160 L Ventilazione Ventilation IC 06
Cost. tempo eccitaz. Field time constant	(ms)	340	
Massa del motore Mass of the motor	(Kg)	302	
Momento d'inerzia rotore Rotor inertia moment	(Kgm2)	0.34	

Avv.	Velocità nominale n/min a tensione nominale di armatura Rated speed (rev/min) at rated voltage							Potenza Power kW	Coppia vel.nomin. Torque at rated speed Nm	Rendimento Efficiency %	Circuito di armatura Armature circuit			Max giri Max. speed (°)
	220	400	440	460	470	520	600				Corrente Current Amp	Res. 115°C mOhm	Ind. mH	
46	1015	---	---	---	---	---	---	34.8	327	86.0	184	132	0.899	3691
		1960	---	---	---	---	---	67.3	328	91.4				4220
		---	2170	---	---	---	---	74.5	328	92.0				4284
		---	---	2275	---	---	---	78.1	328	92.3				4312
		---	---	---	2325	---	---	79.9	328	92.4				4325
		---	---	---	---	2590	---	88.9	328	92.9				4384
		---	---	---	---	---	3005	103	327	93.3				4459
		---	---	---	---	---	---	---	---	---				---
47	845	---	---	---	---	---	---	29.5	333	83.8	160	184	1.34	3109
		1655	---	---	---	---	---	57.8	334	90.3				3566
		---	1835	---	---	---	---	64.0	333	90.9				3620
		---	---	1925	---	---	---	66.9	332	91.5				3659
		---	---	---	1970	---	---	68.3	331	91.4				3677
		---	---	---	---	2195	---	75.4	328	92.4				3767
		---	---	---	---	---	---	---	---	---				---
		---	---	---	---	---	---	---	---	---				---
48	725	---	---	---	---	---	---	25.3	333	82.1	140	241	1.71	2704
		1430	---	---	---	---	---	50.0	334	89.3				3114
		---	1590	---	---	---	---	55.5	333	90.1				3163
		---	---	1670	---	---	---	58.0	332	90.1				3195
		---	---	---	1710	---	---	59.3	331	90.8				3211
		---	---	---	---	1905	---	65.6	329	91.4				3284
		---	---	---	---	---	2220	75.3	324	92.3				3393
		---	---	---	---	---	---	---	---	---				---
49	625	---	---	---	---	---	---	21.9	335	79.6	125	312	1.92	2377
		1255	---	---	---	---	---	44.0	335	88.0				2752
		---	1395	---	---	---	---	48.9	335	88.9				2796
		---	---	1465	---	---	---	51.2	334	89.0				2823
		---	---	---	1500	---	---	52.4	334	89.9				2836
		---	---	---	---	1675	---	58.1	331	90.1				2898
		---	---	---	---	---	1955	66.9	327	91.4				2987
		---	---	---	---	---	---	---	---	---				---
50	570	---	---	---	---	---	---	20.1	337	78.8	116	354	2.50	2594
		1150	---	---	---	---	---	40.6	337	87.5				2999
		---	1280	---	---	---	---	45.1	337	88.4				3046
		---	---	1345	---	---	---	47.3	336	88.6				3074
		---	---	---	1375	---	---	48.4	336	88.8				3088
		---	---	---	---	1535	---	53.7	334	89.8				3151
		---	---	---	---	---	1795	62.1	330	90.8				3240
		---	---	---	---	---	---	---	---	---				---
51	485	---	---	---	---	---	---	17.1	337	74.7	104	457	3.11	1896
		1000	---	---	---	---	---	35.5	339	85.3				2211
		---	1115	---	---	---	---	39.6	339	86.5				2248
		---	---	1175	---	---	---	41.5	337	86.7				2268
		---	---	---	1200	---	---	42.5	338	86.9				2278
		---	---	---	---	1345	---	47.5	337	88.7				2324
		---	---	---	---	---	1575	55.1	334	90.0				2388
		---	---	---	---	---	---	---	---	---				---
52	450	---	---	---	---	---	---	15.9	337	74.5	97	525	3.45	2123
		930	---	---	---	---	---	33.0	339	85.1				2481
		---	1040	---	---	---	---	36.8	338	86.2				2522
		---	---	1095	---	---	---	38.7	338	86.9				2545
		---	---	---	1120	---	---	39.6	338	87.1				2556
		---	---	---	---	1255	---	44.1	336	88.2				2606
		---	---	---	---	---	1470	51.3	333	89.6				2676
		---	---	---	---	---	---	---	---	---				---

Nota (\*) - VENTILAZIONE SOLO L.O. / FAN ONLY SIDE COMMUTATOR

Nota (°) - Regolazione di campo / Field weakening



Potenza eccitazione		
Excitation power	(w)	1300
Cost. tempo eccitaz.		
Field time constant	(ms)	340
Massa del motore		
Mass of the motor	(Kg)	302
Momento d'inerzia rotore		
Rotor inertia moment	(Kgm2)	0.34

Tipo	
Size	MGL C 160 L
Ventilazione	
Ventilation	IC 06

Avv.	Velocità nominale n/min a tensione nominale di armatura Rated speed (rev/min) at rated voltage							Potenza Power kW	Coppia vel.nomin. Torque at rated speed Nm	Rendimento Efficiency %	Circuito di armatura Armature circuit			Max giri Max. speed (°)					
	220	400	440	460	470	520	600				Corrente Current Amp	Res. 115°C mOhm	Ind. mH						
53	390	---	---	---	---	---	---	14.0	343	72.3	88	634	4.34	1582					
		830	---	---	---	---	---	29.5	339	83.8					88	1864			
			925	---	---	---	---	33.0	341	85.2					88	1896			
				975	---	---	---	34.7	340	85.9					87.8	1913			
					995	---	---	35.5	341	86.0					87.8	1921			
						1120	---	39.6	338	87.1					87.4	1959			
							1310	46.2	337	88.8					86.7	2011			
54	360	---	---	---	---	---	---	12.6	334	69.8	82	742	4.50	1806					
		775	---	---	---	---	---	27.1	334	82.6					82	2142			
			870	---	---	---	---	30.3	333	84.0					82	2179			
				915	---	---	---	31.9	333	84.7					81.9	2199			
					935	---	---	32.7	334	85.1					81.8	2209			
						1050	---	36.6	333	86.4					81.5	2252			
55	300	---	---	---	---	---	---	10.7	341	67.1	72.5	940	6.28	1508					
		665	---	---	---	---	---	23.5	338	81.0					72.5	1851			
			745	---	---	---	---	26.3	337	82.4					72.5	1885			
				785	---	---	---	27.7	337	83.2					72.4	1902			
					805	---	---	28.4	337	83.5					72.4	1910			
						905	---	31.8	336	84.8					72.1	1946			
							1065	37.3	334	86.7					71.7	1995			
56	580	---	---	---	---	---	---	20.3	334	79.3	64	1170	8.17	1649					
		650	---	---	---	---	---	22.8	335	81.0					64	1680			
			685	---	---	---	---	24.0	335	81.6					63.9	1696			
				705	---	---	---	24.6	333	81.9					63.9	1703			
					795	---	---	27.7	333	83.6					63.7	1736			
						935	---	32.6	333	85.7					63.4	1779			
57	505	---	---	---	---	---	---	17.8	337	76.7	58	1460	10.1	1468					
		570	---	---	---	---	---	20.1	337	78.8					58	1497			
			600	---	---	---	---	21.2	337	79.6					57.9	1511			
				615	---	---	---	21.8	339	80.1					57.9	1518			
					700	---	---	24.6	336	81.8					57.8	1547			
						825	---	29.0	336	84.1					57.5	1586			
58	445	---	---	---	---	---	---	15.5	333	74.5	52	1800	11.9	1343					
		505	---	---	---	---	---	17.6	333	76.9					52	1371			
			535	---	---	---	---	18.6	332	77.8					52	1385			
				550	---	---	---	19.1	332	78.3					51.9	1391			
					620	---	---	21.6	333	80.2					51.8	1419			
						740	---	25.6	330	82.7					51.6	1456			
59	395	---	---	---	---	---	---	13.9	336	72.4	48	2150	13.7	1217					
		450	---	---	---	---	---	15.8	335	74.8					48	1244			
			475	---	---	---	---	16.7	336	75.6					48	1257			
				490	---	---	---	17.2	335	76.4					47.9	1263			
					555	---	---	19.5	336	78.5					47.8	1289			
						665	---	23.2	333	81.1					47.7	1322			

Nota (\*) - VENTILAZIONE SOLO L.O. / FAN ONLY SIDE COMMUTATOR

Nota (°) - Regolazione di campo / Field weakening





Potenza eccitazione Excitation power	(w)	1300	Tipo Size Ventilazione Ventilation	MGL C 160 L IC 06
Cost. tempo eccitaz. Field time constant	(ms)	340		
Massa del motore Mass of the motor	(Kg)	302		
Momento d'inerzia rotore Rotor inertia moment	(Kgm2)	0.34		

Avv.	Velocità nominale n/min a tensione nominale di armatura Rated speed (rev/min) at rated voltage							Potenza Power kW	Coppia vel.nomin. Torque at rated speed Nm	Rendimento Efficiency %	Circuito di armatura Armature circuit			Max giri Max. speed (°)					
	220	400	440	460	470	520	600				Corrente Current Amp	Res. 115°C mOhm	Ind. mH						
60		355	---	---	---	---	---	12.7	342	70.6	45	2450	16.1	1105					
			405	---	---	---	---	14.5	342	73.2					45	1130			
			430	---	---	---	---	15.4	342	74.4					45	1141			
			445	---	---	---	---	15.8	339	74.7					45	1147			
			505	---	---	---	---	18.0	340	77.1					44.9	1171			
			605	---	---	---	---	21.5	339	80.2					44.7	1201			
61		320	---	---	---	---	---	11.3	337	68.1	41.5	2900	18.1	1025					
			365	---	---	---	---	12.9	338	70.6					41.5	1050			
			390	---	---	---	---	13.8	338	72.3					41.5	1061			
			400	---	---	---	---	14.1	337	72.3					41.5	1066			
			455	---	---	---	---	16.2	340	75.3					41.4	1089			
			550	---	---	---	---	19.4	337	78.3					41.3	1118			
62		291	---	---	---	---	---	10.3	338	66.5	38.7	3270	23.8	953					
			335	---	---	---	---	11.8	336	69.3					38.7	977			
			355	---	---	---	---	12.6	339	70.8					38.7	988			
			365	---	---	---	---	13.0	340	71.5					38.7	993			
			420	---	---	---	---	14.8	337	73.7					38.6	1015			
			505	---	---	---	---	17.9	339	77.5					38.5	1043			
63		264	---	---	---	---	---	9.41	340	64.5	36.5	3710	25.5	883					
			305	---	---	---	---	10.8	338	67.2					36.5	907			
			325	---	---	---	---	11.6	341	69.1					36.5	917			
			335	---	---	---	---	11.9	339	69.4					36.5	922			
			385	---	---	---	---	13.7	340	72.4					36.4	943			
			465	---	---	---	---	16.5	339	75.8					36.3	970			
64		279	---	---	---	---	---	9.82	336	65.6	34	4230	29.0	856					
			298	---	---	---	---	10.5	337	67.1					34	867			
			305	---	---	---	---	10.8	338	67.6					34	872			
			355	---	---	---	---	12.5	336	70.9					33.9	893			
			430	---	---	---	---	15.1	335	74.2					33.9	919			
65			270	---	---	---	---	9.49	336	64.5	32	4870	31.9	816					
				279	---	---	---	9.80	335	65.2					32	820			
				325	---	---	---	11.4	335	68.7					31.9	841			
				395	---	---	---	13.9	336	72.6					31.9	867			

Nota (\*) - VENTILAZIONE SOLO L.O. / FAN ONLY SIDE COMMUTATOR

Nota (°) - Regolazione di campo / Field weakening



Potenza eccitazione Excitation power (w) 1400	
Cost. tempo eccitaz. Field time constant (ms) 360	
Massa del motore Mass of the motor (Kg) 320	
Momento d'inerzia rotore Rotor inertia moment (Kgm2) 0.38	
Tipo Size MGL C 160 P	
Ventilazione Ventilation IC 06	

Avv.	Velocità nominale n/min a tensione nominale di armatura Rated speed (rev/min) at rated voltage							Potenza Power kW	Coppia vel.nomin. Torque at rated speed Nm	Rendimento Efficiency %	Circuito di armatura Armature circuit			Max giri Max. speed (°)				
	220	400	440	460	470	520	600				Corrente Current Amp	Res. 115°C mOhm	Ind. mH					
46	905	---	---	---	---	---	---	34.6	365	85.5	184	141	0.995	3378				
		1755	---	---	---	---	---	67.1	365	91.2	184			3879				
		---	1945	---	---	---	---	74.3	365	91.8	184			3939				
		---	---	2040	---	---	---	77.9	365	92.0	184			3966				
		---	---	---	2085	---	---	79.7	365	92.2	184			3978				
		---	---	---	---	2320	---	88.7	365	92.7	184			4035				
		---	---	---	---	---	2700	103	364	93.3	184			4105				
		---	---	---	---	---	---	---	---	---	---			---	---	---	---	*
47	755	---	---	---	---	---	---	29.3	371	83.2	160	196	1.48	2844				
		1485	---	---	---	---	---	57.5	370	89.8	160			3277				
		---	1645	---	---	---	---	63.8	370	90.6	160			3329				
		---	---	1725	---	---	---	66.7	369	91.2	159			3363				
		---	---	---	1765	---	---	68.2	369	91.3	159			3380				
		---	---	---	---	1970	---	75.3	365	91.7	158			3461				
		---	---	---	---	---	---	---	---	---	---			---	---	---	---	---
		---	---	---	---	---	---	---	---	---	---			---	---	---	---	---
48	645	---	---	---	---	---	---	25.0	370	81.2	140	257	1.89	2472				
		1280	---	---	---	---	---	49.8	372	88.9	140			2862				
		---	1425	---	---	---	---	55.2	370	89.6	140			2908				
		---	---	1495	---	---	---	57.8	369	89.8	140			2937				
		---	---	---	1530	---	---	59.1	369	90.5	139			2951				
		---	---	---	---	1705	---	65.5	367	91.3	138			3018				
		---	---	---	---	---	1990	75.3	361	92.3	136			3115				
		---	---	---	---	---	---	---	---	---	---			---	---	---	---	---
49	555	---	---	---	---	---	---	21.6	372	78.5	125	333	2.13	2171				
		1120	---	---	---	---	---	43.7	373	87.4	125			2528				
		---	1245	---	---	---	---	48.6	373	88.4	125			2569				
		---	---	1310	---	---	---	51.0	372	88.7	125			2595				
		---	---	---	1340	---	---	52.1	371	88.7	125			2607				
		---	---	---	---	1500	---	57.9	369	89.8	124			2663				
		---	---	---	---	---	1750	66.9	365	91.4	122			2744				
		---	---	---	---	---	---	---	---	---	---			---	---	---	---	---
50	505	---	---	---	---	---	---	19.8	374	77.6	116	378	2.77	2369				
		1025	---	---	---	---	---	40.3	376	86.9	116			2755				
		---	1145	---	---	---	---	44.9	375	88.0	116			2800				
		---	---	1200	---	---	---	47.1	375	88.3	116			2826				
		---	---	---	1230	---	---	48.2	374	88.4	116			2838				
		---	---	---	---	1375	---	53.6	372	89.6	115			2896				
		---	---	---	---	---	1605	62.0	369	90.6	114			2977				
		---	---	---	---	---	---	---	---	---	---			---	---	---	---	---
51	430	---	---	---	---	---	---	17.1	380	74.7	104	487	3.44	1729				
		895	---	---	---	---	---	35.5	379	85.3	104			2031				
		---	995	---	---	---	---	39.6	380	86.5	104			2065				
		---	---	1050	---	---	---	41.5	377	86.7	104			2085				
		---	---	---	1075	---	---	42.5	378	86.9	104			2094				
		---	---	---	---	1205	---	47.5	376	88.7	103			2136				
		---	---	---	---	---	1410	55.1	373	90.0	102			2195				
		---	---	---	---	---	---	---	---	---	---			---	---	---	---	---
52	395	---	---	---	---	---	---	15.6	377	73.1	97	560	3.82	1935				
		830	---	---	---	---	---	32.7	376	84.3	97			2278				
		---	925	---	---	---	---	36.6	378	85.8	97			2317				
		---	---	975	---	---	---	38.4	376	86.2	96.8			2338				
		---	---	---	1000	---	---	39.3	375	86.5	96.7			2349				
		---	---	---	---	1120	---	43.9	374	87.7	96.3			2395				
		---	---	---	---	---	1315	51.1	371	89.2	95.5			2459				
		---	---	---	---	---	---	---	---	---	---			---	---	---	---	---

Nota (\*) - VENTILAZIONE SOLO L.O. / FAN ONLY SIDE COMMUTATOR

Nota (°) - Regolazione di campo / Field weakening



Potenza eccitazione Excitation power	(w)	1400	Tipo Size MGL C 160 P Ventilazione Ventilation IC 06
Cost. tempo eccitaz. Field time constant	(ms)	360	
Massa del motore Mass of the motor	(Kg)	320	
Momento d'inerzia rotore Rotor inertia moment	(Kgm2)	0.38	

Avv.	Velocità nominale n/min a tensione nominale di armatura Rated speed (rev/min) at rated voltage							Potenza Power kW	Coppia vel.nomin. Torque at rated speed Nm	Rendimento Efficiency %	Circuito di armatura Armature circuit			Max giri Max. speed (°)			
	220	400	440	460	470	520	600				Corrente Current Amp	Res. 115°C mOhm	Ind. mH				
53	345	---	---	---	---	---	---	13.7	379	70.8	88	677	4.81	1440			
		735	---	---	---	---	---	29.3	381	83.2	88			1711			
		825	---	---	---	---	---	32.7	379	84.5	88			1742			
		870	---	---	---	---	---	34.4	378	85.1	87.9			1758			
		890	---	---	---	---	---	35.2	378	85.3	87.8			1765			
		1000	---	---	---	---	---	39.4	376	86.7	87.4			1800			
		1175	---	---	---	---	---	46.0	374	88.3	86.8			1848			
		---	---	---	---	---	---	---	---	---	---			---	---	---	---
54	315	---	---	---	---	---	---	12.3	373	68.2	82	791	4.98	1585			
		690	---	---	---	---	---	26.8	371	81.7	82			1966			
		775	---	---	---	---	---	30.0	370	83.1	82			2001			
		815	---	---	---	---	---	31.6	370	83.9	81.9			2020			
		835	---	---	---	---	---	32.4	371	84.3	81.8			2029			
		940	---	---	---	---	---	36.3	369	85.7	81.5			2069			
		---	---	---	---	---	---	---	---	---	---			---	---	---	---
55	263	---	---	---	---	---	---	10.3	374	64.6	72.5	1000	6.95	1316			
		590	---	---	---	---	---	23.2	376	80.0	72.5			1698			
		660	---	---	---	---	---	26.0	376	81.5	72.5			1730			
		700	---	---	---	---	---	27.4	374	82.3	72.4			1746			
		715	---	---	---	---	---	28.1	375	82.6	72.4			1754			
		805	---	---	---	---	---	31.6	375	84.3	72.1			1788			
		950	---	---	---	---	---	37.1	373	86.1	71.8			1835			
		---	---	---	---	---	---	---	---	---	---			---	---	---	---
56	510	---	---	---	---	---	---	20.0	375	78.1	64	1250	9.05	1512			
		575	---	---	---	---	---	22.5	374	79.9	64			1542			
		610	---	---	---	---	---	23.8	373	81.0	63.9			1557			
		625	---	---	---	---	---	24.4	373	81.2	63.9			1564			
		705	---	---	---	---	---	27.4	371	82.7	63.7			1595			
		835	---	---	---	---	---	32.3	369	84.9	63.4			1635			
		---	---	---	---	---	---	---	---	---	---			---	---	---	---
		---	---	---	---	---	---	---	---	---	---			---	---	---	---
57	445	---	---	---	---	---	---	17.5	376	75.4	58	1560	11.2	1345			
		505	---	---	---	---	---	19.8	374	77.6	58			1373			
		535	---	---	---	---	---	20.9	373	78.5	57.9			1387			
		545	---	---	---	---	---	21.5	377	79.0	57.9			1393			
		620	---	---	---	---	---	24.4	375	81.0	57.8			1421			
		735	---	---	---	---	---	28.7	373	83.0	57.6			1458			
		---	---	---	---	---	---	---	---	---	---			---	---	---	---
		---	---	---	---	---	---	---	---	---	---			---	---	---	---
58	395	---	---	---	---	---	---	15.2	368	73.1	52	1920	13.2	1230			
		445	---	---	---	---	---	17.3	371	75.6	52			1257			
		470	---	---	---	---	---	18.3	372	76.5	52			1270			
		485	---	---	---	---	---	18.8	370	77.1	51.9			1276			
		550	---	---	---	---	---	21.3	370	79.1	51.8			1303			
		655	---	---	---	---	---	25.3	369	81.7	51.6			1337			
		---	---	---	---	---	---	---	---	---	---			---	---	---	---
		---	---	---	---	---	---	---	---	---	---			---	---	---	---
59	350	---	---	---	---	---	---	13.6	371	70.8	48	2290	15.1	1114			
		395	---	---	---	---	---	15.5	375	73.4	48			1140			
		420	---	---	---	---	---	16.4	373	74.3	48			1152			
		430	---	---	---	---	---	16.9	375	75.1	47.9			1158			
		495	---	---	---	---	---	19.2	370	77.1	47.9			1183			
		590	---	---	---	---	---	22.9	371	80.0	47.7			1215			
		---	---	---	---	---	---	---	---	---	---			---	---	---	---
		---	---	---	---	---	---	---	---	---	---			---	---	---	---

Nota (\*) - VENTILAZIONE SOLO L.O. / FAN ONLY SIDE COMMUTATOR

Nota (°) - Regolazione di campo / Field weakening



Potenza eccitazione		
Excitation power	(w)	1400
Cost. tempo eccitaz.		
Field time constant	(ms)	360
Massa del motore		
Mass of the motor	(Kg)	320
Momento d'inerzia rotore		
Rotor inertia moment	(Kgm2)	0.38

Tipo	
Size	MGL C 160 P
Ventilazione	
Ventilation	IC 06

Avv.	Velocità nominale n/min a tensione nominale di armatura Rated speed (rev/min) at rated voltage							Potenza Power kW	Coppia vel.nomin. Torque at rated speed Nm	Rendimento Efficiency %	Circuito di armatura Armature circuit			Max giri Max. speed (°)
	220	400	440	460	470	520	600				Corrente Current Amp	Res. 115°C mOhm	Ind. mH	
60		315	---	---	---	---	---	12.4	376	68.9	45	2610	17.8	1010
			355	---	---	---	---	14.2	382	71.7	45			1035
				380	---	---	---	15.1	380	72.9	45			1046
					390	---	---	15.5	380	73.3	45			1051
						445	---	17.7	380	75.8	44.9			1074
							535	21.2	378	78.9	44.8			1103
61		279	---	---	---	---	---	11.0	377	66.3	41.5	3100	20	936
			320	---	---	---	---	12.6	376	69.0	41.5			961
				340	---	---	---	13.4	376	70.2	41.5			972
					350	---	---	13.8	377	70.8	41.5			977
						405	---	15.9	375	73.9	41.4			999
							485	19.1	376	77.1	41.3			1027
62		254	---	---	---	---	---	10.0	376	64.6	38.7	3490	26.4	870
			293	---	---	---	---	11.5	375	67.5	38.7			894
				310	---	---	---	12.3	379	69.1	38.7			904
					320	---	---	12.7	379	69.8	38.7			909
						370	---	14.5	374	72.2	38.6			931
							445	17.6	378	76.2	38.5			957
63			266	---	---	---	---	10.5	377	65.4	36.5	3960	28.2	829
				284	---	---	---	11.2	377	66.7	36.5			839
					293	---	---	11.6	378	67.6	36.5			844
						340	---	13.4	376	70.8	36.4			865
							410	16.2	377	74.2	36.4			890
64				260	---	---	---	10.2	375	65.2	34	4520	32.1	793
					268	---	---	10.5	374	65.7	34			797
						310	---	12.2	376	69.2	33.9			818
							380	14.8	372	72.8	33.9			843
65												5200	35.3	
						283	---	11.1	375	66.9	31.9			770
							350	13.5	368	70.5	31.9			795

Nota (\*) - VENTILAZIONE SOLO L.O. / FAN ONLY SIDE COMMUTATOR

Nota (°) - Regolazione di campo / Field weakening



Potenza eccitazione  
Excitation power (w) 1300  
Cost. tempo eccitaz.  
Field time constant (ms) 300  
Massa del motore  
Mass of the motor (Kg) 315  
Momento d'inerzia rotore  
Rotor inertia moment (Kgm2) 0.460

Tipo  
Size MGL C 180 K  
Ventilazione  
Ventilation IC 06

Avv.	Velocità nominale n/min a tensione nominale di armatura Rated speed (rev/min) at rated voltage							Potenza Power kW	Coppia vel. nomin. Torque at rated speed Nm	Rendimento Efficiency %	Circuito di armatura Armature circuit			Max giri Max. speed (°)	
	220	400	440	460	470	520	600				Corrente Current Amp	Res. 115°C mOhm	Ind. mH		
47	1150	---	---	---	---	---	---	39.5	328	85.5	210	116	0.77	3500	*
		2220	---	---	---	---	---	76.3	328	90.8	210			3500	
		2460	---	---	---	---	---	84.4	328	91.3	210			3500	
		2575	---	---	---	---	---	88	327	91.7	209			3500	
		2635	---	---	---	---	---	90.0	326	91.6	209			3500	
		2935	---	---	---	---	---	99.1	322	92.5	206			3500	
		3410	---	---	---	---	---	113	316	93.2	202			3500	
		48	1060	---	---	---	---	---	---	35.7	322			84.5	
2055	---			---	---	---	---	69.3	322	90.2	192	3500			
2275	---			---	---	---	---	76.8	322	90.9	192	3500			
2385	---			---	---	---	---	80	321	91.3	191	3500			
2440	---			---	---	---	---	82	321	91.2	191	3500			
2720	---			---	---	---	---	90.3	317	91.9	189	3500			
3160	---			---	---	---	---	103	311	92.3	186	3500			
49	905			---	---	---	---	---	---	29.8	314	82.6	164	192	1.15
		1775	---	---	---	---	---	58.5	315	89.2	164	3500			
		1970	---	---	---	---	---	64.9	315	89.9	164	3500			
		2065	---	---	---	---	---	67.8	314	90.4	163	3500			
		2115	---	---	---	---	---	69.3	313	90.5	163	3500			
		2355	---	---	---	---	---	76.6	311	90.9	162	3500			
		2745	---	---	---	---	---	87.9	306	92.1	159	3500			
		50	790	---	---	---	---	---	---	26.8	324	81.2	150		
1565	---			---	---	---	---	53.1	324	88.5	150	3500			
1735	---			---	---	---	---	58.9	324	89.2	150	3500			
1825	---			---	---	---	---	61.7	323	89.4	150	3500			
1865	---			---	---	---	---	63.1	323	90.1	149	3500			
2080	---			---	---	---	---	69.8	321	90.7	148	3500			
2425	---			---	---	---	---	80.4	317	91.8	146	3500			
51	690			---	---	---	---	---	---	23.3	323	79.0	134	296	1.79
		1390	---	---	---	---	---	46.8	322	87.3	134	3500			
		1545	---	---	---	---	---	52.0	321	88.2	134	3500			
		1620	---	---	---	---	---	54.5	321	88.4	134	3500			
		1660	---	---	---	---	---	55.7	320	88.4	134	3500			
		1855	---	---	---	---	---	61.9	319	89.5	133	3500			
		2165	---	---	---	---	---	71.5	315	91.0	131	3500			
		52	620	---	---	---	---	---	---	21.1	325	78.0	123		
1255	---			---	---	---	---	42.7	325	86.8	123	3192			
1395	---			---	---	---	---	47.5	325	87.8	123	3252			
1465	---			---	---	---	---	49.8	325	88.0	123	3285			
1500	---			---	---	---	---	51.0	325	88.2	123	3301			
1680	---			---	---	---	---	56.6	322	89.2	122	3376			
1960	---			---	---	---	---	65.5	319	90.2	121	3479			
53	555			---	---	---	---	---	---	18.7	322	76.6	111	410	2.70
		1140	---	---	---	---	---	38.1	319	85.8	111	2958			
		1265	---	---	---	---	---	42.5	321	87.0	111	3015			
		1330	---	---	---	---	---	44.6	320	87.3	111	3046			
		1365	---	---	---	---	---	45.6	319	87.4	111	3061			
		1525	---	---	---	---	---	50.7	318	88.6	110	3130			
		1785	---	---	---	---	---	58.9	315	90.1	109	3224			

Nota (\*) - VENTILAZIONE SOLO L.O. / FAN ONLY SIDE COMMUTATOR

Nota (°) - Regolazione di campo / Field weakening



Potenza eccitazione  
Excitation power (w) 1300  
Cost. tempo eccitaz.  
Field time constant (ms) 300  
Massa del motore  
Mass of the motor (Kg) 315  
Momento d'inerzia rotore  
Rotor inertia moment (Kgm2) 0.460

Tipo  
Size MGL C 180 K  
Ventilazione  
Ventilation IC 06

Avv.	Velocità nominale n/min a tensione nominale di armatura Rated speed (rev/min) at rated voltage							Potenza Power kW	Coppia vel. nomin. Torque at rated speed Nm	Rendimento Efficiency %	Circuito di armatura Armature circuit			Max giri Max. speed (°)		
	220	400	440	460	470	520	600				Corrente Current Amp	Res. 115°C mOhm	Ind. mH			
54	495	---	---	---	---	---	---	16.5	318	73.5	102	509	2.83	2266		
		1030	---	---	---	---	---	34.4	319	84.3					102	2731
		1150	---	---	---	---	---	38.4	319	85.6					102	2786
			1210	---	---	---	---	40.3	318	85.9					102	2815
		1240	---	---	---	---	---	41.3	318	86.1					102	2829
			1390	---	---	---	---	46.0	316	87.6					101	2892
		1630		---	---	---	---	53.5	313	89.2					100	2979
			55	450	---	---	---	---	---	---					15.4	327
950	---	---			---	---	---	32.4	326	83.5	97.0	2483				
1060	---	---			---	---	---	36.2	326	84.8	97.0	2532				
	1115	---			---	---	---	38.0	325	85.3	96.8	2558				
1140	---	---			---	---	---	38.9	326	85.5	96.8	2570				
	1280	---			---	---	---	43.5	325	86.8	96.4	2627				
1500		---			---	---	---	50.7	323	88.3	95.7	2704				
	56	415			---	---	---	---	---	---	14.1	324	71.2	90.0	640	4.20
880			---	---	---	---	---	29.9	325	83.1	90.0	2326				
985			---	---	---	---	---	33.4	324	84.3	90.0	2373				
			1035	---	---	---	---	35.1	324	84.9	89.9	2397				
1060			---	---	---	---	---	36.0	324	85.3	89.8	2408				
			1190	---	---	---	---	40.2	323	86.4	89.5	2461				
1395				---	---	---	---	46.9	321	87.9	88.9	2532				
			57	380	---	---	---	---	---	---	12.7	319	69.6			
815	---	---			---	---	---	27.3	320	82.2	83.0	2205				
915	---	---			---	---	---	30.5	318	83.5	83.0	2252				
	960	---			---	---	---	32.1	319	84.2	82.9	2275				
985	---	---			---	---	---	32.9	319	84.5	82.8	2286				
	1105	---			---	---	---	36.8	318	85.8	82.5	2336				
1300		---			---	---	---	43.0	316	87.4	82.0	2404				
	58	350			---	---	---	---	---	---	11.9	325	68.0	79.6	810	5.04
760			---	---	---	---	---	25.9	325	81.3	79.6	2040				
850			---	---	---	---	---	29.0	326	82.8	79.6	2083				
			895	---	---	---	---	30.5	325	83.4	79.5	2104				
920			---	---	---	---	---	31.3	325	83.8	79.5	2114				
			1035	---	---	---	---	35.1	324	85.2	79.2	2160				
1215				---	---	---	---	41.1	323	86.9	78.8	2222				
			59	325	---	---	---	---	---	---	11.2	329	66.5			
710	---	---			---	---	---	24.7	332	80.7	76.5	1856				
795	---	---			---	---	---	27.7	333	82.3	76.5	1895				
	840	---			---	---	---	29.1	331	82.8	76.4	1914				
860	---	---			---	---	---	29.8	331	83.0	76.4	1923				
	970	---			---	---	---	33.5	330	84.7	76.1	1963				
1140		---			---	---	---	39.3	329	86.5	75.7	2018				
	60	620			---	---	---	---	---	---	20.9	322	78.2	66.8	1170	7.00
700			---	---	---	---	---	23.5	321	80.0	66.8	1778				
735			---	---	---	---	---	24.8	322	80.8	66.7	1797				
			755	---	---	---	---	25.4	321	81.0	66.7	1806				
855			---	---	---	---	---	28.6	319	82.7	66.5	1846				
			1010	---	---	---	---	33.7	319	84.8	66.2	1899				

Nota (\*) - VENTILAZIONE SOLO L.O. / FAN ONLY SIDE COMMUTATOR

Nota (°) - Regolazione di campo / Field weakening



Potenza eccitazione  
 Excitation power (w) 1300  
 Cost. tempo eccitaz.  
 Field time constant (ms) 300  
 Massa del motore  
 Mass of the motor (Kg) 315  
 Momento d'inerzia rotore  
 Rotor inertia moment (Kgm2) 0.460

Tipo  
 Size MGL C 180 K  
 Ventilazione  
 Ventilation IC 06

Avv.	Velocità nominale n/min a tensione nominale di armatura Rated speed (rev/min) at rated voltage							Potenza Power kW	Coppia vel.nomin. Torque at rated speed Nm	Rendimento Efficiency %	Circuito di armatura Armature circuit			Max giri Max. speed (°)
	220	400	440	460	470	520	600				Corrente Current Amp	Res. 115°C mOhm	Ind. mH	
61		525	---	---	---	---	---	18.2	331	75.8	60.0	1460	9.63	1464
			590	---	---	---	---	20.5	332	77.7	60.0			1498
				625	---	---	---	21.7	332	78.8	59.9			1514
					640	---	---	22.3	333	79.2	59.9			1522
						725	---	25.2	332	81.0	59.8			1556
							860	29.8	331	83.3	59.6			1599
62		445	---	---	---	---	---	14.9	320	73.0	51.0	1950	12.0	1326
			505	---	---	---	---	16.9	320	75.3	51.0			1360
				535	---	---	---	17.9	320	76.3	51.0			1376
					550	---	---	18.3	318	76.5	50.9			1383
						625	---	20.8	318	78.7	50.8			1416
							745	24.7	317	81.2	50.7			1458

Nota (\*) - VENTILAZIONE SOLO L.O. / FAN ONLY SIDE COMMUTATOR

Nota (°) - Regolazione di campo / Field weakening





Potenza eccitazione		
Excitation power	(w)	1450
Cost. tempo eccitaz.		
Field time constant	(ms)	330
Massa del motore		
Mass of the motor	(Kg)	345
Momento d'inerzia rotore		
Rotor inertia moment	(Kgm2)	0.500

Tipo		
Size	MGL C 180	S
Ventilazione		
Ventilation		IC 06

Avv.	Velocità nominale n/min a tensione nominale di armatura Rated speed (rev/min) at rated voltage							Potenza Power kW	Coppia vel. nomin. Torque at rated speed Nm	Rendimento Efficiency %	Circuito di armatura Armature circuit			Max giri Max. speed (°)
	220	400	440	460	470	520	600				Corrente Current Amp	Res. 115°C mOhm	Ind. mH	
46	1140	---	---	---	---	---	---	46.0	385	86.4	242	94.3	0.66	3500
		2190	---	---	---	---	---	88.4	386	91.3	242			3500
		---	2420	---	---	---	---	97.8	386	91.8	242			3500
		---	---	2540	---	---	---	102	384	92.0	241			3500
		---	---	---	2595	---	---	104	383	92.2	240			3500
		---	---	---	---	2890	---	114	377	92.5	237			3500
		---	---	---	---	---	3355	130	370	93.4	232			3500
		---	---	---	---	---	---	---	---	---	---			---
47	930	---	---	---	---	---	---	39.2	403	84.8	210	128	0.93	3324
		1805	---	---	---	---	---	76.1	403	90.6	210			3500
		---	2000	---	---	---	---	84.3	403	91.2	210			3500
		---	---	2095	---	---	---	88	402	91.6	209			3500
		---	---	---	2145	---	---	90	400	91.5	209			3500
		---	---	---	---	2390	---	99.2	396	92.2	207			3500
		---	---	---	---	---	2775	114	392	93.6	203			3500
		---	---	---	---	---	---	---	---	---	---			---
48	855	---	---	---	---	---	---	35.3	394	83.6	192	154	1.07	2911
		1670	---	---	---	---	---	69.1	395	90.0	192			3350
		---	1850	---	---	---	---	76.6	395	90.7	192			3403
		---	---	1940	---	---	---	80.1	394	91.2	191			3437
		---	---	---	1985	---	---	81.8	394	91.1	191			3454
		---	---	---	---	2210	---	90.4	391	92.0	189			3500
		---	---	---	---	---	2575	104	386	93.2	186			3500
		---	---	---	---	---	---	---	---	---	---			---
49	725	---	---	---	---	---	---	29.3	386	81.2	164	212	1.39	3293
		1440	---	---	---	---	---	58.2	386	88.7	164			3500
		---	1600	---	---	---	---	64.6	386	89.5	164			3500
		---	---	1675	---	---	---	67.6	385	89.6	164			3500
		---	---	---	1715	---	---	69.1	385	90.2	163			3500
		---	---	---	---	1915	---	76.6	382	90.9	162			3500
		---	---	---	---	---	2230	88.1	377	91.8	160			3500
		---	---	---	---	---	---	---	---	---	---			---
50	635	---	---	---	---	---	---	26.3	396	79.7	150	255	1.69	2853
		1265	---	---	---	---	---	52.8	399	88.0	150			3401
		---	1410	---	---	---	---	58.6	397	88.8	150			3468
		---	---	1480	---	---	---	61.4	396	89.0	150			3500
		---	---	---	1515	---	---	62.8	396	89.7	149			3500
		---	---	---	---	1690	---	69.7	394	90.6	148			3500
		---	---	---	---	---	1970	80.5	390	91.3	147			3500
		---	---	---	---	---	---	---	---	---	---			---
51	550	---	---	---	---	---	---	22.8	396	77.3	134	327	2.16	2554
		1125	---	---	---	---	---	46.4	394	86.6	134			3070
		---	1250	---	---	---	---	51.7	395	87.7	134			3132
		---	---	1315	---	---	---	54.2	394	87.9	134			3166
		---	---	---	1345	---	---	55.4	393	88.0	134			3182
		---	---	---	---	1505	---	61.7	392	89.2	133			3258
		---	---	---	---	---	1755	71.4	389	90.2	132			3363
		---	---	---	---	---	---	---	---	---	---			---
52	495	---	---	---	---	---	---	20.7	399	76.5	123	375	2.61	2297
		1015	---	---	---	---	---	42.3	398	86.0	123			2766
		---	1130	---	---	---	---	47.2	399	87.2	123			2822
		---	---	1185	---	---	---	49.5	399	87.5	123			2852
		---	---	---	1215	---	---	50.6	398	87.5	123			2866
		---	---	---	---	1360	---	56.4	396	88.9	122			2933
		---	---	---	---	---	1590	65.4	393	90.1	121			3024
		---	---	---	---	---	---	---	---	---	---			---

Nota (\*) - VENTILAZIONE SOLO L.O. / FAN ONLY SIDE COMMUTATOR

Nota (\*) - Regolazione di campo / Field weakening





Potenza eccitazione  
Excitation power (w) 1450  
Cost. tempo eccitaz.  
Field time constant (ms) 330  
Massa del motore  
Mass of the motor (Kg) 345  
Momento d'inerzia rotore  
Rotor inertia moment (Kgm2) 0.500

Tipo  
Size MGL C 180 S  
Ventilazione  
Ventilation IC 06

Avv.	Velocità nominale n/min a tensione nominale di armatura Rated speed (rev/min) at rated voltage							Potenza Power kW	Coppia vel. nomin. Torque at rated speed Nm	Rendimento Efficiency %	Circuito di armatura Armature circuit			Max giri Max. speed (°)
	220	400	440	460	470	520	600				Corrente Current Amp	Res. 115°C mOhm	Ind. mH	
53	445	---	---	---	---	---	---	18.2	391	74.5	111	454	3.26	2110
		920	---	---	---	---	---	37.7	391	84.9	111			2561
		1025	---	---	---	---	---	42.1	392	86.2	111			2615
		---	1075	---	---	---	---	44.2	393	86.6	111			2643
		---	---	1105	---	---	---	45.3	392	86.8	111			2657
		---	---	---	1235	---	---	50.5	391	88.3	110			2718
		---	---	---	---	---	1445	58.7	388	89.8	109			2802
		54	390	---	---	---	---	---	---	16.0	392			71.3
830	---			---	---	---	---	34.0	391	83.3	102	2363		
---	930			---	---	---	---	38.0	390	84.7	102	2415		
---	---			975	---	---	---	39.9	391	85.0	102	2441		
---	---			---	1000	---	---	40.9	391	85.3	102	2453		
---	---			---	---	1125	---	45.7	388	87.0	101	2511		
---	---			---	---	---	1320	53.3	386	88.0	101	2589		
55	355			---	---	---	---	---	---	14.9	401	69.8	97.0	634
		760	---	---	---	---	---	32.0	402	82.5	97.0	2148		
		---	855	---	---	---	---	35.8	400	83.9	97.0	2195		
		---	---	900	---	---	---	37.6	399	84.4	96.9	2218		
		---	---	---	920	---	---	38.5	400	84.6	96.8	2230		
		---	---	---	---	1035	---	43.1	398	86.0	96.4	2281		
		---	---	---	---	---	1215	50.4	396	87.6	95.9	2350		
		56	325	---	---	---	---	---	---	13.6	400	68.7	90.0	
705	---			---	---	---	---	29.5	400	81.9	90.0	2011		
---	790			---	---	---	---	33.0	399	83.3	90.0	2056		
---	---			835	---	---	---	34.7	397	83.9	89.9	2078		
---	---			---	855	---	---	35.6	398	84.3	89.8	2089		
---	---			---	---	960	---	39.8	396	85.5	89.5	2137		
---	---			---	---	---	1130	46.6	394	87.3	89.0	2201		
57	298			---	---	---	---	---	---	12.2	391	66.8	83.0	811
		655	---	---	---	---	---	26.9	392	81.0	83.0	1906		
		---	735	---	---	---	---	30.1	391	82.4	83.0	1950		
		---	---	775	---	---	---	31.7	391	83.1	82.9	1971		
		---	---	---	795	---	---	32.5	390	83.4	82.9	1981		
		---	---	---	---	895	---	36.5	389	85.0	82.6	2028		
		---	---	---	---	---	1050	42.7	388	86.6	82.2	2089		
		58	274	---	---	---	---	---	---	11.4	397	65.1	79.6	
610	---			---	---	---	---	25.5	399	80.1	79.6	1763		
---	685			---	---	---	---	28.6	399	81.7	79.6	1804		
---	---			720	---	---	---	30.1	399	82.3	79.5	1823		
---	---			---	740	---	---	30.9	399	82.7	79.5	1833		
---	---			---	---	835	---	34.7	397	84.3	79.2	1875		
---	---			---	---	---	980	40.7	397	86.0	78.9	1931		
59	570			---	---	---	---	---	---	24.2	405	79.1	76.5	980
		640	---	---	---	---	---	27.2	406	80.8	76.5	1638		
		---	---	---	---	---	---	28.7	406	81.7	76.4	1656		
		---	675	---	---	---	---	29.4	407	81.9	76.4	1664		
		---	---	---	690	---	---	33.1	405	83.5	76.2	1702		
		---	---	---	---	780	---	38.9	404	85.5	75.8	1751		
		---	---	---	---	---	920	38.9	404	85.5	75.8	1751		

Nota (\*) - VENTILAZIONE SOLO L.O. / FAN ONLY SIDE COMMUTATOR

Nota (°) - Regolazione di campo / Field weakening



Potenza eccitazione  
Excitation power (w) 1450  
Cost. tempo eccitaz.  
Field time constant (ms) 330  
Massa del motore  
Mass of the motor (Kg) 345  
Momento d'inerzia rotore  
Rotor inertia moment (Kgm2) 0.500

Tipo  
Size MGL C 180 S  
Ventilazione  
Ventilation IC 06

Avv.	Velocità nominale n/min a tensione nominale di armatura Rated speed (rev/min) at rated voltage							Potenza Power kW	Coppia vel. nomin. Torque at rated speed Nm	Rendimento Efficiency %	Circuito di armatura Armature circuit			Max giri Max. speed (°)
	220	400	440	460	470	520	600				Corrente Current Amp	Res. 115°C mOhm	Ind. mH	
60		495	---	---	---	---	---	20.4	394	76.3	66.8	1290	8.46	1499
			560	---	---	---	---	23.0	392	78.3	66.8			1537
				590	---	---	---	24.3	393	79.2	66.7			1555
					605	---	---	25.0	395	79.7	66.7			1563
						685	---	28.2	393	81.4	66.6			1601
							810	33.3	393	83.7	66.3			1650
61		415	---	---	---	---	---	17.7	407	73.8	60.0	1610	11.6	1261
			470	---	---	---	---	20.1	408	76.1	60.0			1294
				500	---	---	---	21.2	405	76.8	60.0			1309
					510	---	---	21.8	408	77.4	59.9			1317
						580	---	24.7	407	79.4	59.8			1348
							690	29.3	406	81.9	59.6			1389
62		350	---	---	---	---	---	14.4	393	70.6	51.0	2150	14.4	1139
			400	---	---	---	---	16.4	392	73.1	51.0			1173
				425	---	---	---	17.4	391	74.2	51.0			1188
					435	---	---	17.9	393	74.7	51.0			1195
						500	---	20.4	390	77.1	50.9			1226
							595	24.3	390	79.9	50.7			1266

Nota (\*) - VENTILAZIONE SOLO L.O. / FAN ONLY SIDE COMMUTATOR

Nota (°) - Regolazione di campo / Field weakening



Potenza eccitazione		
Excitation power	(w)	1600
Cost. tempo eccitaz.		
Field time constant	(ms)	360
Massa del motore		
Mass of the motor	(Kg)	378
Momento d'inerzia rotore		
Rotor inertia moment	(Kgm2)	0.570

Tipo		
Size	MGL C 180	M
Ventilazione		
Ventilation		IC 06

Avv.	Velocità nominale n/min a tensione nominale di armatura Rated speed (rev/min) at rated voltage							Potenza Power kW	Coppia vel. nomin. Torque at rated speed Nm	Rendimento Efficiency %	Circuito di armatura Armature circuit			Max giri Max. speed (°)	
	220	400	440	460	470	520	600				Corrente Current Amp	Res. 115°C mOhm	Ind. mH		
45	1220	---	---	---	---	---	---	56.8	445	87.5	295	69.4	0.47	3500	*
		2330	---	---	---	---	---	108	443	91.5	295			3500	
		---	2575	---	---	---	---	120	445	92.4	295			3500	
		---	---	2700	---	---	---	125	442	92.7	293			3500	
		---	---	---	2760	---	---	128	443	93.3	292			3500	
		---	---	---	---	3070	---	140	436	93.5	288			3500	
		---	---	---	---	---	---	---	---	---	---			---	
46	950	---	---	---	---	---	---	45.6	458	85.6	242	103	0.78	3500	
		1840	---	---	---	---	---	88.1	457	91.0	242			3500	
		---	2040	---	---	---	---	97.6	457	91.7	242			3500	
		---	---	2135	---	---	---	102	456	92.0	241			3500	
		---	---	---	2185	---	---	104	455	91.8	241			3500	
		---	---	---	---	2435	---	115	451	92.9	238			3500	
		---	---	---	---	---	2830	131	442	93.3	234			3500	
47	775	---	---	---	---	---	---	38.7	477	83.8	210	140	1.09	2911	*
		1515	---	---	---	---	---	75.8	478	90.2	210			3350	
		---	1680	---	---	---	---	84.0	478	90.9	210			3403	
		---	---	1765	---	---	---	87.8	475	91.3	209			3437	
		---	---	---	1805	---	---	89.7	475	91.3	209			3454	
		---	---	---	---	2010	---	99.2	471	92.2	207			3500	
		---	---	---	---	---	2340	114	465	93.1	204			3500	
48	710	---	---	---	---	---	---	34.9	469	82.6	192	169	1.25	3263	
		1400	---	---	---	---	---	68.7	469	89.5	192			3500	
		---	1555	---	---	---	---	76.2	468	90.2	192			3500	
		---	---	1630	---	---	---	79.8	468	90.8	191			3500	
		---	---	---	1670	---	---	81.5	466	90.8	191			3500	
		---	---	---	---	1860	---	90.2	463	91.3	190			3500	
		---	---	---	---	---	2165	104	459	92.7	187			3500	
49	605	---	---	---	---	---	---	28.9	456	80.1	164	233	1.63	2871	
		1205	---	---	---	---	---	57.8	458	88.1	164			3460	
		---	1340	---	---	---	---	64.2	458	89.0	164			3500	
		---	---	1410	---	---	---	67.3	456	89.2	164			3500	
		---	---	---	1440	---	---	68.8	456	89.8	163			3500	
		---	---	---	---	1610	---	76.3	453	90.6	162			3500	
		---	---	---	---	---	1875	88.1	449	91.2	161			3500	
50	525	---	---	---	---	---	---	25.9	471	78.5	150	280	1.99	2486	
		1060	---	---	---	---	---	52.4	472	87.3	150			3000	
		---	1180	---	---	---	---	58.2	471	88.2	150			3062	
		---	---	1240	---	---	---	61.1	471	88.6	150			3096	
		---	---	---	1270	---	---	62.5	470	88.7	150			3113	
		---	---	---	---	1420	---	69.4	467	89.6	149			3189	
		---	---	---	---	---	1660	80.4	463	91.2	147			3295	
51	455	---	---	---	---	---	---	22.3	468	75.6	134	358	2.53	2222	
		940	---	---	---	---	---	46.0	467	85.8	134			2706	
		---	1045	---	---	---	---	51.2	468	86.8	134			2765	
		---	---	1100	---	---	---	53.8	467	87.3	134			2796	
		---	---	---	1125	---	---	55.0	467	87.3	134			2810	
		---	---	---	---	1260	---	61.3	465	88.6	133			2878	
		---	---	---	---	---	1475	71.2	461	89.9	132			2972	

Nota (\*) - VENTILAZIONE SOLO L.O. / FAN ONLY SIDE COMMUTATOR

Nota (°) - Regolazione di campo / Field weakening



Potenza eccitazione  
Excitation power (w) 1600  
Cost. tempo eccitaz.  
Field time constant (ms) 360  
Massa del motore  
Mass of the motor (Kg) 378  
Momento d'inerzia rotore  
Rotor inertia moment (Kgm2) 0.570

Tipo  
Size MGL C 180 M  
Ventilazione  
Ventilation IC 06

Avv.	Velocità nominale n/min a tensione nominale di armatura Rated speed (rev/min) at rated voltage							Potenza Power kW	Coppia vel. nomin. Torque at rated speed Nm	Rendimento Efficiency %	Circuito di armatura Armature circuit			Max giri Max. speed (°)
	220	400	440	460	470	520	600				Corrente Current Amp	Res. 115°C mOhm	Ind. mH	
52	410	---	---	---	---	---	---	20.2	471	74.6	123	411	3.06	1996
		845	---	---	---	---	---	41.9	474	85.2	123			
			945	---	---	---	---	46.7	472	86.3	123			
				995	---	---	---	49.1	471	86.8	123			
					1020	---	---	50.3	471	87.0	123			
						1140	---	56.1	470	88.4	122			
							1335	65.2	466	89.8	121			
53	365	---	---	---	---	---	---	17.7	463	72.5	111	498	3.82	1818
		765	---	---	---	---	---	37.3	466	84.0	111			
			855	---	---	---	---	41.7	466	85.4	111			
				900	---	---	---	43.8	465	85.8	111			
					925	---	---	44.9	464	86.1	111			
						1035	---	50.1	462	87.6	110			
							1215	58.4	459	88.5	110			
54	320	---	---	---	---	---	---	15.5	463	69.1	102	618	4.01	1598
		690	---	---	---	---	---	33.5	464	82.1	102			
			775	---	---	---	---	37.5	462	83.6	102			
				815	---	---	---	39.5	463	84.2	102			
					835	---	---	40.5	463	84.5	102			
						940	---	45.3	460	86.3	101			
							1105	53.0	458	87.5	101			
55	289	---	---	---	---	---	---	14.3	473	67.0	97.0	694	4.78	1443
		635	---	---	---	---	---	31.5	474	81.2	97.0			
			710	---	---	---	---	35.3	475	82.7	97.0			
				750	---	---	---	37.2	474	83.5	96.9			
					770	---	---	38.1	473	83.7	96.8			
						865	---	42.7	471	85.1	96.5			
							1015	50.1	471	87.0	96.0			
56	265	---	---	---	---	---	---	13.1	472	66.2	90.0	776	5.94	1324
		585	---	---	---	---	---	29.0	473	80.6	90.0			
			660	---	---	---	---	32.5	470	82.1	90.0			
				695	---	---	---	34.3	471	82.9	89.9			
					710	---	---	35.1	472	83.2	89.8			
						800	---	39.4	470	84.6	89.6			
							945	46.3	468	86.5	89.2			
57	242	---	---	---	---	---	---	11.7	462	64.1	83.0	889	6.51	1208
		545	---	---	---	---	---	26.4	463	79.5	83.0			
			610	---	---	---	---	29.7	465	81.3	83.0			
				645	---	---	---	31.3	463	81.1	83.9			
					660	---	---	32.1	464	82.4	82.9			
						745	---	36.1	463	84.0	82.6			
							880	42.4	460	85.9	82.3			
58		505	---	---	---	---	---	25.0	473	78.5	79.6	981	7.14	1550
			570	---	---	---	---	28.1	471	80.2	79.6			
				600	---	---	---	29.7	473	81.2	79.5			
					615	---	---	30.4	472	81.4	79.5			
						695	---	34.3	471	83.2	79.3			
							820	40.4	471	85.2	79.0			

Nota (\*) - VENTILAZIONE SOLO L.O. / FAN ONLY SIDE COMMUTATOR

Nota (°) - Regolazione di campo / Field weakening



Potenza eccitazione  
Excitation power (w) 1600  
Cost. tempo eccitaz.  
Field time constant (ms) 360  
Massa del motore  
Mass of the motor (Kg) 378  
Momento d'inerzia rotore  
Rotor inertia moment (Kgm2) 0.570

Tipo  
Size MGL C 180 M  
Ventilazione  
Ventilation IC 06

Avv.	Velocità nominale n/min a tensione nominale di armatura Rated speed (rev/min) at rated voltage							Potenza Power kW	Coppia vel.nomin. Torque at rated speed Nm	Rendimento Efficiency %	Circuito di armatura Armature circuit			Max giri Max. speed (°)
	220	400	440	460	470	520	600				Corrente Current Amp	Res. 115°C mOhm	Ind. mH	
59		470	---	---	---	---	---	23.7	482	77.5	76.5	1070	8.09	1407
			530	---	---	---	---	26.7	481	79.3	76.5			1441
				560	---	---	---	28.2	481	80.2	76.4			1458
					575	---	---	29.0	482	80.8	76.4			1466
						650	---	32.7	480	82.5	76.2			1500
							770	38.5	478	84.5	75.9			1546
60		405	---	---	---	---	---	19.9	469	74.5	66.8	1410	9.91	1315
			460	---	---	---	---	22.5	467	76.6	66.8			1351
				490	---	---	---	23.8	464	77.6	66.7			1368
					500	---	---	24.5	468	78.2	66.7			1376
						570	---	27.7	464	80.0	66.6			1411
							675	32.9	465	82.6	66.4			1457
61		340	---	---	---	---	---	17.2	483	71.7	60.0	1770	13.6	1105
			385	---	---	---	---	19.6	486	74.2	60.0			1137
				410	---	---	---	20.7	482	75.0	60.0			1151
					420	---	---	21.3	484	75.7	59.9			1158
						480	---	24.2	481	77.8	59.8			1188
							575	28.9	480	80.7	59.7			1227
62		286	---	---	---	---	---	13.9	464	68.1	51.0	2360	16.9	996
			330	---	---	---	---	15.9	460	70.9	51.0			1028
				350	---	---	---	16.9	461	72.0	51.0			1042
					360	---	---	17.4	462	72.6	51.0			1049
						410	---	19.9	464	75.2	50.9			1079
							495	23.8	459	78.1	50.8			1116

Nota (\*) - VENTILAZIONE SOLO L.O. / FAN ONLY SIDE COMMUTATOR

Nota (°) - Regolazione di campo / Field weakening



Potenza eccitazione		
Excitation power	(w)	1850
Cost. tempo eccitaz.		
Field time constant	(ms)	390
Massa del motore		
Mass of the motor	(Kg)	420
Momento d'inerzia rotore		
Rotor inertia moment	(Kgm2)	0.660

Tipo		
Size	MGL C 180	L
Ventilazione		
Ventilation		IC 06

Avv.	Velocità nominale n/min a tensione nominale di armatura Rated speed (rev/min) at rated voltage							Potenza Power kW	Coppia vel. nomin. Torque at rated speed Nm	Rendimento Efficiency %	Circuito di armatura Armature circuit			Max giri Max. speed (°)	
	220	400	440	460	470	520	600				Corrente Current Amp	Res. 115°C mOhm	Ind. mH		
45	1010	---	---	---	---	---	---	56.3	532	86.7	295	77.0	0.56	3500	*
		1940	---	---	---	---	---	108	532	91.5	295			3500	
		---	2150	---	---	---	---	120	533	92.4	295			3500	
		---	---	2255	---	---	---	125	529	92.4	294			3500	
		---	---	---	2305	---	---	128	530	92.9	293			3500	
		---	---	---	---	2565	---	140	521	93.2	289			3500	
		---	---	---	---	---	2975	159	510	94.0	282			3500	
		---	---	---	---	---	---	---	---	---	---			---	
46	785	---	---	---	---	---	---	45.1	549	84.7	242	115	0.92	3132	*
		1535	---	---	---	---	---	87.8	546	90.7	242			3500	
		---	1700	---	---	---	---	97.2	546	91.3	242			3500	
		---	---	1780	---	---	---	102	547	92.0	241			3500	
		---	---	---	1825	---	---	104	544	91.8	241			3500	
		---	---	---	---	2030	---	115	541	92.9	238			3500	
		---	---	---	---	---	2360	131	530	92.9	235			3500	
		---	---	---	---	---	---	---	---	---	---			---	
47	640	---	---	---	---	---	---	38.2	570	82.7	210	156	1.29	2517	*
		1260	---	---	---	---	---	75.3	571	89.6	210			2922	
		---	1400	---	---	---	---	83.5	570	90.4	210			2970	
		---	---	1465	---	---	---	87.4	570	90.9	209			3000	
		---	---	---	1500	---	---	89.4	569	91.0	209			3015	
		---	---	---	---	1675	---	98.9	564	91.4	208			3082	
		---	---	---	---	---	1950	114	558	92.7	205			3179	
		---	---	---	---	---	---	---	---	---	---			---	
48	585	---	---	---	---	---	---	34.3	560	81.2	192	188	1.48	2812	*
		1165	---	---	---	---	---	68.2	559	88.8	192			3391	
		---	1290	---	---	---	---	75.8	561	89.7	192			3463	
		---	---	1355	---	---	---	79.4	560	89.9	192			3500	
		---	---	---	1390	---	---	81.1	557	90.3	191			3500	
		---	---	---	---	1550	---	90.0	555	91.1	190			3500	
		---	---	---	---	---	1805	104	550	92.2	188			3500	
		---	---	---	---	---	---	---	---	---	---			---	
49	495	---	---	---	---	---	---	28.3	546	78.4	164	258	1.93	2468	*
		1000	---	---	---	---	---	57.3	547	87.3	164			3013	
		---	1115	---	---	---	---	63.7	546	88.3	164			3080	
		---	---	1170	---	---	---	66.8	545	88.5	164			3116	
		---	---	---	1195	---	---	68.3	546	89.2	163			3133	
		---	---	---	---	1340	---	76.0	542	89.7	163			3214	
		---	---	---	---	---	1565	87.9	536	91.0	161			3327	
		---	---	---	---	---	---	---	---	---	---			---	
50	430	---	---	---	---	---	---	25.3	562	76.7	150	310	2.35	2136	*
		880	---	---	---	---	---	51.8	562	86.3	150			2612	
		---	980	---	---	---	---	57.7	562	87.4	150			2670	
		---	---	1030	---	---	---	60.5	561	87.7	150			2700	
		---	---	---	1055	---	---	62.0	561	87.9	150			2715	
		---	---	---	---	1180	---	69.0	558	89.1	149			2782	
		---	---	---	---	---	1380	80.1	554	90.2	148			2875	
		---	---	---	---	---	---	---	---	---	---			---	
51	370	---	---	---	---	---	---	21.7	560	73.6	134	398	2.99	1852	*
		775	---	---	---	---	---	45.4	559	84.7	134			2355	
		---	865	---	---	---	---	50.7	560	86.0	134			2409	
		---	---	910	---	---	---	53.2	558	86.3	134			2437	
		---	---	---	935	---	---	54.5	557	86.5	134			2450	
		---	---	---	---	1045	---	60.8	556	87.9	133			2511	
		---	---	---	---	---	1225	70.9	553	89.5	132			2594	
		---	---	---	---	---	---	---	---	---	---			---	

Nota (\*) - VENTILAZIONE SOLO L.O. / FAN ONLY SIDE COMMUTATOR

Nota (°) - Regolazione di campo / Field weakening



Potenza eccitazione  
Excitation power (w) 1850  
Cost. tempo eccitaz.  
Field time constant (ms) 390  
Massa del motore  
Mass of the motor (Kg) 420  
Momento d'inerzia rotore  
Rotor inertia moment (Kgm2) 0.660

Tipo  
Size MGL C 180 L  
Ventilazione  
Ventilation IC 06

Avv.	Velocità nominale n/min a tensione nominale di armatura Rated speed (rev/min) at rated voltage							Potenza Power kW	Coppia vel. nomin. Torque at rated speed Nm	Rendimento Efficiency %	Circuito di armatura Armature circuit			Max giri Max. speed (°)
	220	400	440	460	470	520	600				Corrente Current Amp	Res. 115°C mOhm	Ind. mH	
52	330	---	---	---	---	---	---	19.6	567	72.4	123	456	3.63	1655
		700	---	---	---	---	---	41.3	563	83.9	123			2121
			780	---	---	---	---	46.2	566	85.4	123			2170
				820	---	---	---	48.5	565	85.7	123			2195
					845	---	---	49.7	562	86.0	123			2206
						945	---	55.6	562	87.6	122			2260
							1110	64.8	558	88.5	122			2333
53	294	---	---	---	---	---	---	17.1	555	70.0	111	553	4.53	1468
		630	---	---	---	---	---	36.7	556	82.7	111			1961
			705	---	---	---	---	41.1	557	84.2	111			2008
				745	---	---	---	43.2	554	84.6	111			2032
					760	---	---	44.3	557	84.9	111			2043
						855	---	49.6	554	86.7	110			2094
							1005	58	551	87.9	110			2161
54	256	---	---	---	---	---	---	14.8	552	66.0	102	686	4.74	1281
		570	---	---	---	---	---	32.9	551	80.6	102			1806
			635	---	---	---	---	36.9	555	82.2	102			1852
				670	---	---	---	38.9	554	82.9	102			1874
					690	---	---	39.9	552	83.2	102			1885
						775	---	44.8	552	84.5	102			1932
							915	52.5	548	86.6	101			1996
55	230	---	---	---	---	---	---	13.7	569	64.2	97.0	770	5.65	1151
		520	---	---	---	---	---	30.8	566	79.4	97.0			1641
			585	---	---	---	---	34.7	566	81.3	97.0			1683
				615	---	---	---	36.5	567	81.9	96.9			1703
					630	---	---	37.5	568	82.4	96.8			1712
						710	---	42.1	566	83.8	96.6			1755
							840	49.5	563	85.8	96.1			1812
56		480	---	---	---	---	---	28.4	565	78.9	90.0	862	7.04	1536
			540	---	---	---	---	31.9	564	80.6	90.0			1575
				570	---	---	---	33.7	565	81.5	89.9			1594
					585	---	---	34.5	563	81.7	89.9			1603
						660	---	38.9	563	83.5	89.6			1644
							780	45.8	561	85.5	89.3			1697
57		445	---	---	---	---	---	25.8	554	77.7	83.0			986
			500	---	---	---	---	29.1	556	79.7	83.0	1492		
				530	---	---	---	30.7	553	79.5	83.9	1511		
					545	---	---	31.5	552	80.8	82.9	1520		
						615	---	35.5	551	82.6	82.7	1559		
							725	41.9	552	84.7	82.4	1610		
58		410	---	---	---	---	---	24.4	568	76.6	79.6	1090	8.44	
			465	---	---	---	---	27.5	565	78.5	79.6			1380
				490	---	---	---	29.1	567	79.6	79.5			1397
					505	---	---	29.8	564	79.8	79.5			1405
						570	---	33.7	565	81.7	79.3			1441
							675	39.8	563	83.9	79.1			1488

Nota (\*) - VENTILAZIONE SOLO L.O. / FAN ONLY SIDE COMMUTATOR

Nota (°) - Regolazione di campo / Field weakening





Potenza eccitazione  
Excitation power (w) 1850  
Cost. tempo eccitaz.  
Field time constant (ms) 390  
Massa del motore  
Mass of the motor (Kg) 420  
Momento d'inerzia rotore  
Rotor inertia moment (Kgm2) 0.660

Tipo  
Size MGL C 180 L  
Ventilazione  
Ventilation IC 06

Avv.	Velocità nominale n/min a tensione nominale di armatura Rated speed (rev/min) at rated voltage							Potenza Power kW	Coppia vel.nomin. Torque at rated speed Nm	Rendimento Efficiency %	Circuito di armatura Armature circuit			Max giri Max. speed (°)
	220	400	440	460	470	520	600				Corrente Current Amp	Res. 115°C mOhm	Ind. mH	
59		385	---	---	---	---	---	23.1	573	75.5	76.5	1190	9.58	1218 1251 1266 1273 1306 1347
			435	---	---	---	---	26.1	573	77.5	76.5			
				460	---	---	---	27.6	573	78.5	76.4			
					470	---	---	28.4	577	79.1	76.4			
						535	---	32.1	573	80.9	76.3			
							635	38.0	572	83.3	76.0			
60		330	---	---	---	---	---	19.3	559	72.2	66.8	1570	11.7	1137 1171 1187 1195 1228 1270
			375	---	---	---	---	21.9	558	74.5	66.8			
				395	---	---	---	23.2	561	75.5	66.8			
					410	---	---	23.9	557	76.2	66.7			
						465	---	27.1	557	78.3	66.6			
							555	32.3	556	81.1	66.4			
61		274	---	---	---	---	---	16.5	575	68.8	60.0	1960	16.1	954 984 998 1005 1033 1069
			315	---	---	---	---	18.9	573	71.6	60.0			
				335	---	---	---	20.1	573	72.8	60.0			
					345	---	---	20.7	573	73.4	60.0			
						390	---	23.6	578	75.8	59.9			
							470	28.3	575	79.0	59.7			
62		229	---	---	---	---	---	13.3	555	65.2	51.0	2620	20.0	856 888 901 908 936 972
			264	---	---	---	---	15.3	553	68.2	51.0			
				281	---	---	---	16.3	554	69.5	51.0			
					290	---	---	16.8	553	70.1	51.0			
						335	---	19.3	550	72.9	50.9			
							400	23.2	554	76.1	50.8			

Nota (\*) - VENTILAZIONE SOLO L.O. / FAN ONLY SIDE COMMUTATOR

Nota (°) - Regolazione di campo / Field weakening



Potenza eccitazione		
Excitation power	(w)	2100
Cost. tempo eccitaz.		
Field time constant	(ms)	410
Massa del motore		
Mass of the motor	(Kg)	455
Momento d'inerzia rotore		
Rotor inertia moment	(Kgm2)	0.740

Tipo		
Size	MGL C 180	P
Ventilazione		
Ventilation		IC 06

Avv.	Velocità nominale n/min a tensione nominale di armatura Rated speed (rev/min) at rated voltage							Potenza Power kW	Coppia vel. nomin. Torque at rated speed Nm	Rendimento Efficiency %	Circuito di armatura Armature circuit			Max giri Max. speed (°)	
	220	400	440	460	470	520	600				Corrente Current Amp	Res. 115°C mOhm	Ind. mH		
45	885	---	---	---	---	---	---	55.9	603	86.1	295	83.1	0.26	3200	
		1710	---	---	---	---	---	108	603	91.5	295				3200
		---	1895	---	---	---	---	120	605	92.4	295				3200
		---	---	1985	---	---	---	125	601	92.4	294				3200
		---	---	---	2035	---	---	127	596	92.2	293				3200
		---	---	---	---	2260	---	140	592	92.8	290				3200
		---	---	---	---	---	2630	160	581	93.9	284				3200
		---	---	---	---	---	---	---	---	---	---				---
46	690	---	---	---	---	---	---	44.6	617	83.8	242	124	1.03	2824	
		1350	---	---	---	---	---	87.4	618	90.3	242				3200
		---	1495	---	---	---	---	96.9	619	91.0	242				3200
		---	---	1570	---	---	---	101	614	91.1	241				3200
		---	---	---	1605	---	---	104	619	91.8	241				3200
		---	---	---	---	1790	---	114	608	91.7	239				3200
		---	---	---	---	---	2085	131	600	92.9	235				3200
		---	---	---	---	---	---	---	---	---	---				---
47	560	---	---	---	---	---	---	37.7	643	81.6	210	168	1.45	2268	
		1110	---	---	---	---	---	74.9	644	89.2	210				2650
		---	1230	---	---	---	---	83.1	645	89.9	210				2696
		---	---	1290	---	---	---	87.1	645	90.6	209				2723
		---	---	---	1320	---	---	89.0	644	90.6	209				2736
		---	---	---	---	1475	---	98.7	639	91.3	208				2796
		---	---	---	---	---	1720	114	633	92.7	205				2883
		---	---	---	---	---	---	---	---	---	---				---
48	510	---	---	---	---	---	---	33.8	633	80.0	192	202	1.67	2528	
		1020	---	---	---	---	---	67.8	635	88.3	192				3073
		---	1135	---	---	---	---	75.3	634	89.1	192				3141
		---	---	1195	---	---	---	79.0	631	89.4	192				3178
		---	---	---	1220	---	---	80.8	632	90.0	191				3196
		---	---	---	---	1365	---	89.7	628	90.8	190				3200
		---	---	---	---	---	1590	104	625	92.2	188				3200
		---	---	---	---	---	---	---	---	---	---				---
49	430	---	---	---	---	---	---	27.8	617	77.1	164	279	2.17	2145	
		875	---	---	---	---	---	56.8	620	86.6	164				2729
		---	975	---	---	---	---	63.3	620	87.7	164				2792
		---	---	1025	---	---	---	66.4	619	88.0	164				2826
		---	---	---	1050	---	---	67.9	618	88.1	164				2842
		---	---	---	---	1175	---	75.6	614	89.2	163				2915
		---	---	---	---	---	1375	87.7	609	90.8	161				3018
		---	---	---	---	---	---	---	---	---	---				---
50	370	---	---	---	---	---	---	24.8	640	75.2	150	335	2.64	1857	
		770	---	---	---	---	---	51.3	636	85.5	150				2366
		---	860	---	---	---	---	57.2	635	86.7	150				2420
		---	---	905	---	---	---	60.1	634	87.1	150				2449
		---	---	---	925	---	---	61.5	635	87.2	150				2462
		---	---	---	---	1035	---	68.6	633	88.5	149				2524
		---	---	---	---	---	1215	79.8	627	89.9	148				2609
		---	---	---	---	---	---	---	---	---	---				---
51	320	---	---	---	---	---	---	21.2	633	71.9	134	429	3.37	1599	
		680	---	---	---	---	---	44.9	631	83.8	134				2131
		---	760	---	---	---	---	50.2	631	85.1	134				2183
		---	---	800	---	---	---	52.8	630	85.7	134				2209
		---	---	---	820	---	---	54.0	629	85.7	134				2221
		---	---	---	---	920	---	60.4	627	87.3	133				2277
		---	---	---	---	---	1075	70.5	626	89.0	132				2353
		---	---	---	---	---	---	---	---	---	---				---

Nota (\*) - VENTILAZIONE SOLO L.O. / FAN ONLY SIDE COMMUTATOR

Nota (°) - Regolazione di campo / Field weakening



Potenza eccitazione		
Excitation power	(w)	2100
Cost. tempo eccitaz.		
Field time constant	(ms)	410
Massa del motore		
Mass of the motor	(Kg)	455
Momento d'inerzia rotore		
Rotor inertia moment	(Kgm2)	0.740

Tipo	
Size	MGL C 180 P
Ventilazione	
Ventilation	IC 06

Avv.	Velocità nominale n/min a tensione nominale di armatura Rated speed (rev/min) at rated voltage							Potenza Power kW	Coppia vel. nomin. Torque at rated speed Nm	Rendimento Efficiency %	Circuito di armatura Armature circuit			Max giri Max. speed (°)					
	220	400	440	460	470	520	600				Corrente Current Amp	Res. 115°C mOhm	Ind. mH						
52	285	---	---	---	---	---	---	19.1	640	70.6	123	492	4.08	1296					
		610	---	---	---	---	---	40.9	640	83.1	123				1745				
		---	685	---	---	---	---	45.7	637	84.4	123				1787				
		---	---	720	---	---	---	48.1	638	85.0	123				1808				
		---	---	---	740	---	---	49.3	636	85.3	123				1818				
		---	---	---	---	830	---	55.1	634	86.9	122				1864				
		---	---	---	---	---	975	64.5	632	88.1	122				1925				
		53	252	---	---	---	---	---	---	16.6	629				68.0	111	597	5.09	1145
550	---			---	---	---	---	36.3	630	81.8	111	1613							
---	615			---	---	---	---	40.6	630	83.1	111	1654							
---	---			650	---	---	---	42.8	629	83.8	111	1674							
---	---			---	665	---	---	43.8	629	84.0	111	1683							
---	---			---	---	750	---	49.2	626	86.0	110	1725							
---	---			---	---	---	885	57.6	622	87.3	110	1783							
54	495			---	---	---	---	---	---	32.4	625	79.4	102	740	5.33	1484			
		555	---	---	---	---	---	36.4	626	81.1	102	1524							
		---	585	---	---	---	---	38.4	627	81.8	102	1543							
		---	---	600	---	---	---	39.4	627	82.2	102	1552							
		---	---	---	680	---	---	44.3	622	83.5	102	1592							
		---	---	---	---	800	---	52.1	622	86.0	101	1645							
		55	450	---	---	---	---	---	---	30.3	643	78.1	97.0				831	6.35	1348
				510	---	---	---	---	---	34.1	639	79.9	97.0						
---	535			---	---	---	---	36.0	643	80.8	96.9	1402							
---	---			550	---	---	---	37.0	642	81.2	96.9	1410							
---	---			---	625	---	---	41.7	637	83.0	96.6	1446							
---	---			---	---	735	---	49.1	638	85.1	96.2	1645							
56	420			---	---	---	---	---	---	27.9	634	77.5	90.0	930	7.91	1261			
				470	---	---	---	---	---	31.4	638	79.3	90.0						
		---	495	---	---	---	---	33.2	641	80.3	89.9	1312							
		---	---	510	---	---	---	34.0	637	80.5	89.9	1319							
		---	---	---	575	---	---	38.4	638	82.3	89.7	1355							
		---	---	---	---	685	---	45.3	632	84.5	89.3	1399							
		57	385	---	---	---	---	---	---	25.3	628	76.2	83.0				1060	8.66	1193
				435	---	---	---	---	---	28.6	628	78.3	83.0						
---	460			---	---	---	---	30.2	627	78.3	83.9	1243							
---	---			475	---	---	---	31.0	623	79.6	82.9	1250							
---	---			---	535	---	---	35.0	625	81.4	82.7	1284							
---	---			---	---	635	---	41.4	623	83.7	82.4	1327							
58	355			---	---	---	---	---	---	23.9	643	75.1	79.6	1170	9.49	1102			
				405	---	---	---	---	---	27.0	637	77.1	79.6						
		---	425	---	---	---	---	28.6	643	78.2	79.5	1149							
		---	---	440	---	---	---	29.3	636	78.4	79.5	1155							
		---	---	---	500	---	---	33.2	634	80.4	79.4	1187							
		---	---	---	---	590	---	39.4	638	83.0	79.1	1227							

Nota (\*) - VENTILAZIONE SOLO L.O. / FAN ONLY SIDE COMMUTATOR

Nota (°) - Regolazione di campo / Field weakening



Potenza eccitazione  
Excitation power (w) 2100  
Cost. tempo eccitaz.  
Field time constant (ms) 410  
Massa del motore  
Mass of the motor (Kg) 455  
Momento d'inerzia rotore  
Rotor inertia moment (Kgm2) 0.740

Tipo MGL C 180 P  
Size  
Ventilazione  
Ventilation IC 06

Avv.	Velocità nominale n/min a tensione nominale di armatura Rated speed (rev/min) at rated voltage							Potenza Power kW	Coppia vel.nomin. Torque at rated speed Nm	Rendimento Efficiency %	Circuito di armatura Armature circuit			Max giri Max. speed (°)
	220	400	440	460	470	520	600				Corrente Current Amp	Res. 115°C mOhm	Ind. mH	
59		330	---	---	---	---	---	22.6	654	73.9	76.5	1280	10.8	1099
			375	---	---	---	---	25.6	652	76.1	76.5			1130
				400	---	---	---	27.1	647	77.1	76.4			1144
					410	---	---	27.9	650	77.7	76.4			1151
						465	---	31.6	649	79.6	76.3			1182
							555	37.5	645	82.2	76.0			1221
60		284	---	---	---	---	---	18.8	632	70.4	66.8	1690	13.2	1023
			325	---	---	---	---	21.4	629	72.8	66.8			1057
				345	---	---	---	22.7	628	73.9	66.8			1072
					355	---	---	23.4	629	74.6	66.7			1079
						405	---	26.6	627	76.8	66.6			1111
							485	31.8	626	79.7	66.5			1151
61		235	---	---	---	---	---	16.0	650	66.7	60.0	2120	18.1	857
			269	---	---	---	---	18.4	653	69.7	60.0			887
				287	---	---	---	19.6	652	71.0	60.0			900
					295	---	---	20.1	651	71.3	60.0			907
						340	---	23.1	649	74.2	59.9			934
							410	27.8	648	77.5	59.8			968
62			225	---	---	---	---	14.8	628	66.0	51.0	2820	22.5	798
				241	---	---	---	15.8	626	67.3	51.0			811
					248	---	---	16.3	628	68.0	51.0			818
						287	---	18.8	626	71.0	50.9			845
							350	22.8	622	74.8	50.8			879

Nota (\*) - VENTILAZIONE SOLO L.O. / FAN ONLY SIDE COMMUTATOR

Nota (°) - Regolazione di campo / Field weakening



Potenza eccitazione Excitation power (w)	2400	Tipo Size	MGL C 180 X
Cost. tempo eccitaz. Field time constant (ms)	430		
Massa del motore Mass of the motor (Kg)	506	Ventilazione Ventilation	IC 06
Momento d'inerzia rotore Rotor inertia moment (Kgm2)	0.830		

Avv.	Velocità nominale n/min a tensione nominale di armatura Rated speed (rev/min) at rated voltage							Potenza Power kW	Coppia vel. nomin. Torque at rated speed Nm	Rendimento Efficiency %	Circuito di armatura Armature circuit			Max giri Max. speed (°)
	220	400	440	460	470	520	600				Corrente Current Amp	Res. 115°C mOhm	Ind. mH	
45	750	----	----	----	----	----	----	55.1	702	84.9	295	91.9	0.71	2909
		1460	----	----	----	----	----	107	700	90.7	295			2909
		1620	----	----	----	----	----	119	702	91.7	295			2909
			1695	----	----	----	----	124	699	91.7	294			2909
		1735	----	----	----	----	----	127	699	92.2	293			2909
			1935	----	----	----	----	139	686	92.2	290			2909
		2255	----	----	----	----	----	159	673	93.3	284			2909
		46	615	----	----	----	----	----	----	44.3	688			83.2
1205	----			----	----	----	----	87.0	690	89.9	242	2909		
1335	----			----	----	----	----	96.5	690	90.6	242	2909		
	1405			----	----	----	----	101	687	91.1	241	2909		
1435	----			----	----	----	----	103	685	90.9	241	2909		
	1600			----	----	----	----	114	680	91.7	239	2909		
1865	----			----	----	----	----	131	671	92.9	235	2909		
47	450			----	----	----	----	----	----	34.8	739	75.3	210	211.8
		910	----	----	----	----	----	70.7	742	84.2	210	2409		
		1015	----	----	----	----	----	78.6	740	85.1	210	2451		
			1065	----	----	----	----	82.6	741	85.9	209	2475		
		1090	----	----	----	----	----	84.6	741	86.1	209	2487		
			1220	----	----	----	----	94.6	741	87.5	208	2542		
		1425	----	----	----	----	----	111	744	90.2	205	2621		
		48	425	----	----	----	----	----	----	32.5	730	76.9	192	
870	----			----	----	----	----	66.4	729	86.5	192	2794		
965	----			----	----	----	----	73.9	731	87.5	192	2855		
	1015			----	----	----	----	77.7	731	88.0	192	2889		
1040	----			----	----	----	----	79.2	727	88.2	191	2905		
	1165			----	----	----	----	88.2	723	89.3	190	2909		
1365	----			----	----	----	----	102	714	90.4	188	2909		
49	370			----	----	----	----	----	----	27.2	702	75.4	164	292.4
		765	----	----	----	----	----	56.2	702	85.7	164	2481		
		855	----	----	----	----	----	62.6	699	86.8	164	2538		
			895	----	----	----	----	65.8	702	87.2	164	2569		
		920	----	----	----	----	----	67.4	700	87.4	164	2584		
			1030	----	----	----	----	75.0	695	88.5	163	2650		
		1205	----	----	----	----	----	86.8	688	89.9	161	2744		
		50	315	----	----	----	----	----	----	23.6	715	71.5	150	
670	----			----	----	----	----	50.0	713	83.3	150	2151		
750	----			----	----	----	----	55.8	711	84.5	150	2200		
	790			----	----	----	----	58.7	710	85.1	150	2226		
810	----			----	----	----	----	60.2	710	85.4	150	2238		
	910			----	----	----	----	67.1	704	86.6	149	2295		
1070	----			----	----	----	----	78.2	698	88.1	148	2372		
51	286			----	----	----	----	----	----	20.9	698	70.9	134	431.5
		610	----	----	----	----	----	44.4	695	82.8	134	1937		
		680	----	----	----	----	----	49.6	697	84.1	134	1985		
			715	----	----	----	----	52.2	697	84.7	134	2008		
		735	----	----	----	----	----	53.5	695	84.9	134	2019		
			825	----	----	----	----	59.6	690	86.2	133	2070		
		970	----	----	----	----	----	69.5	684	87.8	132	2139		

Nota (\*) - VENTILAZIONE SOLO L.O. / FAN ONLY SIDE COMMUTATOR

Nota (°) - Regolazione di campo / Field weakening



Potenza eccitazione		
Excitation power	(w)	2400
Cost. tempo eccitaz.		
Field time constant	(ms)	430
Massa del motore		
Mass of the motor	(Kg)	506
Momento d'inerzia rotore		
Rotor inertia moment	(Kgm2)	0.830

Tipo		
Size	MGL C 180	X
Ventilazione		
Ventilation		IC 06

Avv.	Velocità nominale n/min a tensione nominale di armatura Rated speed (rev/min) at rated voltage							Potenza Power kW	Coppia vel. nomin. Torque at rated speed Nm	Rendimento Efficiency %	Circuito di armatura Armature circuit			Max giri Max. speed (°)			
	220	400	440	460	470	520	600				Corrente Current Amp	Res. 115°C mOhm	Ind. mH				
52	255	---	---	---	---	---	---	18.6	697	68.7	123	509.3	4.61	1296			
		550	---	---	---	---	---	40.2	698	81.7	123				1745		
		615	---	---	---	---	---	44.9	697	83.0	123				1787		
		650	---	---	---	---	---	47.3	695	83.6	123				1808		
		665	---	---	---	---	---	48.5	697	83.9	123				1818		
		750	---	---	---	---	---	54.1	689	85.3	122				1864		
		880	---	---	---	---	---	63.6	690	86.9	122				1925		
		---	---	---	---	---	---	---	---	---	---				---	---	---
53	230	---	---	---	---	---	---	16.4	681	67.2	111	590.7	5.75	1145			
		505	---	---	---	---	---	35.8	677	80.6	111				1613		
		565	---	---	---	---	---	40.2	679	82.3	111				1654		
		595	---	---	---	---	---	42.3	679	82.8	111				1674		
		610	---	---	---	---	---	43.4	679	83.2	111				1683		
		685	---	---	---	---	---	48.4	675	84.6	110				1725		
		810	---	---	---	---	---	56.9	671	86.2	110				1783		
		---	---	---	---	---	---	---	---	---	---				---	---	---
54	455	---	---	---	---	---	---	32.3	678	79.2	102	712.4	6.02	1484			
		515	---	---	---	---	---	36.2	671	80.7	102				1524		
		540	---	---	---	---	---	38.2	676	81.4	102				1543		
		555	---	---	---	---	---	39.2	675	81.8	102				1552		
		625	---	---	---	---	---	44.2	675	83.3	102				1592		
		740	---	---	---	---	---	51.6	666	85.1	101				1645		
		---	---	---	---	---	---	---	---	---	---				---	---	---
		---	---	---	---	---	---	---	---	---	---				---	---	---
55	420	---	---	---	---	---	---	30.3	689	78.1	97.0	812.9	7.18	1348			
		470	---	---	---	---	---	34.2	695	80.1	97.0				1385		
		500	---	---	---	---	---	36.1	690	81.0	96.9				1402		
		510	---	---	---	---	---	37	693	81.2	96.9				1410		
		575	---	---	---	---	---	41.8	694	83.2	96.6				1446		
		680	---	---	---	---	---	49.4	694	85.6	96.2				1645		
		---	---	---	---	---	---	---	---	---	---				---	---	---
		---	---	---	---	---	---	---	---	---	---				---	---	---
56	380	---	---	---	---	---	---	27.1	681	75.3	90.0	973.9	8.94	1261			
		430	---	---	---	---	---	30.6	680	77.3	90.0				1295		
		455	---	---	---	---	---	32.4	680	78.3	89.9				1312		
		470	---	---	---	---	---	33.3	677	78.8	89.9				1319		
		530	---	---	---	---	---	37.6	678	80.6	89.7				1355		
		630	---	---	---	---	---	44.6	676	83.2	89.3				1399		
		---	---	---	---	---	---	---	---	---	---				---	---	---
		---	---	---	---	---	---	---	---	---	---				---	---	---
57	350	---	---	---	---	---	---	24.4	666	73.5	83.0	1165.1	8.79	1193			
		395	---	---	---	---	---	27.6	667	75.6	83.0				1226		
		420	---	---	---	---	---	29.2	664	75.7	83.9				1243		
		430	---	---	---	---	---	30.0	666	77.0	82.9				1250		
		490	---	---	---	---	---	34.1	665	79.3	82.7				1284		
		580	---	---	---	---	---	40.6	669	82.1	82.4				1327		
		---	---	---	---	---	---	---	---	---	---				---	---	---
		---	---	---	---	---	---	---	---	---	---				---	---	---
58	330	---	---	---	---	---	---	23.6	683	74.1	79.6	1179.8	10.7	1102			
		375	---	---	---	---	---	26.7	680	76.2	79.6				1135		
		400	---	---	---	---	---	28.2	673	77.1	79.5				1149		
		410	---	---	---	---	---	29.0	675	77.6	79.5				1155		
		465	---	---	---	---	---	32.9	676	79.7	79.4				1187		
		550	---	---	---	---	---	39.1	679	82.4	79.1				1227		
		---	---	---	---	---	---	---	---	---	---				---	---	---
		---	---	---	---	---	---	---	---	---	---				---	---	---

Nota (\*) - VENTILAZIONE SOLO L.O. / FAN ONLY SIDE COMMUTATOR

Nota (°) - Regolazione di campo / Field weakening



Potenza eccitazione  
Excitation power (w) 2400  
Cost. tempo eccitaz.  
Field time constant (ms) 430  
Massa del motore  
Mass of the motor (Kg) 506  
Momento d'inerzia rotore  
Rotor inertia moment (Kgm2) 0.830

Tipo  
Size MGL C 180 X  
Ventilazione  
Ventilation IC 06

Avv.	Velocità nominale n/min a tensione nominale di armatura Rated speed (rev/min) at rated voltage							Potenza Power kW	Coppia vel.nomin. Torque at rated speed Nm	Rendimento Efficiency %	Circuito di armatura Armature circuit			Max giri Max. speed (°)
	220	400	440	460	470	520	600				Corrente Current Amp	Res. 115°C mOhm	Ind. mH	
59		310	---	---	---	---	---	22.5	693	73.5	76.5	1289.1	12.2	1000
			350	---	---	---	---	25.5	696	75.8	76.5			1027
				370	---	---	---	27.0	697	76.8	76.4			1040
					385	---	---	27.7	687	77.1	76.4			1046
						435	---	31.5	692	79.4	76.3			1075
							520	37.5	689	82.2	76.0			1110
60		300	---	---	---	---	---	19.5	621	73.0	66.8	1425.9	14.9	930
			340	---	---	---	---	22.1	621	75.2	66.8			961
				360	---	---	---	23.3	618	75.8	66.8			975
					370	---	---	24.0	619	76.6	66.7			981
						415	---	27.2	626	78.5	66.6			1010
							495	32.3	623	81.0	66.5			1046
61		275	---	---	---	---	---	17.1	594	71.3	60.0	1594.5	20.5	779
			315	---	---	---	---	19.4	588	73.5	60.0			806
				335	---	---	---	20.6	587	74.6	60.0			818
					345	---	---	21.2	587	75.2	60.0			825
						390	---	24.1	590	77.4	59.9			849
							465	28.7	589	80.0	59.8			880
62			310	---	---	---	---	17.1	527	76.2	51.0	1763.1	25.4	725
				330	---	---	---	18.1	524	77.2	51.0			737
					340	---	---	18.6	522	77.6	51.0			744
						385	---	21.0	521	79.3	50.9			768
							455	25.0	525	82.0	50.8			799

Nota (\*) - VENTILAZIONE SOLO L.O. / FAN ONLY SIDE COMMUTATOR

Nota (°) - Regolazione di campo / Field weakening





Potenza eccitazione Excitation power (w) 2000	Tipo Size MGL C 200 K
Cost. tempo eccitaz. Field time constant (ms) 350	Ventilazione Ventilation IC 06
Massa del motore Mass of the motor (Kg) 510	
Momento d'inerzia rotore Rotor inertia moment (Kgm2) 0.8	

Avv.	Velocità nominale n/min a tensione nominale di armatura Rated speed (rev/min) at rated voltage							Potenza Power kW	Coppia vel. nomin. Torque at rated speed Nm	Rendimento Efficiency %	Circuito di armatura Armature circuit			Max giri Max. speed (°)
	220	400	440	460	470	520	600				Corrente Current Amp	Res. 115°C mOhm	Ind. mH	
50	1155	---	---	---	---	---	---	67.9	561.4	86.9	355	60.5	0.72	3200
		2210	---	---	---	---	---	130	561.7	91.5	355			3200
		2445	---	---	---	---	---	144	562.4	92.2	355			3200
		2565	---	---	---	---	---	150	558.4	92.4	353			3200
		2620	---	---	---	---	---	153	557.6	92.2	353			3200
		2915	---	---	---	---	---	169	553.6	93.1	349			3200
		---	---	---	---	---	---	---	---	---	---			---
51	1035	---	---	---	---	---	---	67.6	623.7	86.6	355	64.0	0.78	3200
		1985	---	---	---	---	---	130	625.4	91.5	355			3200
		2195	---	---	---	---	---	144	626.5	92.2	355			3200
		2305	---	---	---	---	---	150	621.4	92.1	354			3200
		2355	---	---	---	---	---	153	620.4	92.2	353			3200
		2620	---	---	---	---	---	169	616.0	93.1	349			3200
		3045	---	---	---	---	---	192	602.1	93.6	342			3200
52	925	---	---	---	---	---	---	60.6	625.6	86.1	320	75.2	0.8	3200
		1785	---	---	---	---	---	117	625.9	91.4	320			3200
		1975	---	---	---	---	---	129	623.7	91.6	320			3200
		2070	---	---	---	---	---	135	622.8	92.0	319			3200
		2120	---	---	---	---	---	138	621.6	92.3	318			3200
		2360	---	---	---	---	---	152	615.0	92.8	315			3200
		2740	---	---	---	---	---	173	602.9	93.3	309			3200
53	830	---	---	---	---	---	---	55.3	636.2	84.6	297	91.6	0.91	3200
		1615	---	---	---	---	---	108	638.6	90.9	297			3200
		1785	---	---	---	---	---	119	636.6	91.1	297			3200
		1875	---	---	---	---	---	125	636.6	91.8	296			3200
		1920	---	---	---	---	---	127	631.6	91.3	296			3200
		2135	---	---	---	---	---	141	630.7	92.5	293			3200
		2485	---	---	---	---	---	161	618.7	92.8	289			3200
54	750	---	---	---	---	---	---	46.7	594.6	83.2	255	118	1.03	3200
		1470	---	---	---	---	---	92	594.4	89.7	255			3200
		1630	---	---	---	---	---	102	597.6	90.9	255			3200
		1710	---	---	---	---	---	106	591.9	90.7	254			3200
		1750	---	---	---	---	---	108	589.3	90.5	254			3200
		1950	---	---	---	---	---	120	587.7	91.6	252			3200
		2270	---	---	---	---	---	138	580.5	92.4	249			3200
55	690	---	---	---	---	---	---	45.3	626.9	83.0	248	124	1.32	2844
		1355	---	---	---	---	---	89	627.2	89.7	248			3200
		1505	---	---	---	---	---	99	626.3	90.5	248			3200
		1580	---	---	---	---	---	103	622.5	90.7	247			3200
		1615	---	---	---	---	---	106	626.8	91.3	247			3200
		1800	---	---	---	---	---	117	620.7	91.8	245			3200
		2095	---	---	---	---	---	134	610.8	92.3	242			3200
56	625	---	---	---	---	---	---	38.0	580.6	80.7	214	167	1.47	3002
		1245	---	---	---	---	---	76	579.9	88.3	214			3200
		1380	---	---	---	---	---	84	581.3	89.2	214			3200
		1450	---	---	---	---	---	88	579.5	89.4	214			3200
		1485	---	---	---	---	---	90	578.7	89.9	213			3200
		1655	---	---	---	---	---	100	575.8	90.5	212			3200
		1930	---	---	---	---	---	115	569.0	91.3	210			3200

Nota (\*) - VENTILAZIONE SOLO L.O. / FAN ONLY SIDE COMMUTATOR

Nota (°) - Regolazione di campo / Field weakening



Potenza eccitazione Excitation power (w) 2000	Tipo Size MGL C 200 K
Cost. tempo eccitaz. Field time constant (ms) 350	Ventilazione Ventilation IC 06
Massa del motore Mass of the motor (Kg) 510	
Momento d'inerzia rotore Rotor inertia moment (Kgm2) 0.8	

Avv.	Velocità nominale n/min a tensione nominale di armatura Rated speed (rev/min) at rated voltage							Potenza Power kW	Coppia vel. nomin. Torque at rated speed Nm	Rendimento Efficiency %	Circuito di armatura Armature circuit			Max giri Max. speed (°)
	220	400	440	460	470	520	600				Corrente Current Amp	Res. 115°C mOhm	Ind. mH	
57	580	---	---	---	---	---	---	34.4	566.4	79.8	196	193	1.81	2891
		1155	---	---	---	---	---	68.9	569.7	87.9	196			3200
		1285	---	---	---	---	---	76.5	568.5	88.7	196			3200
			1350	---	---	---	---	80.2	567.3	89.0	196			3200
		1540	---	---	---	1380	---	82	567.4	89.5	195			3200
			---	---	---	---	---	91	564.3	90.2	194			3200
			---	---	---	---	---	1800	105	557.0	91.1			192
58	515	---	---	---	---	---	---	26.3	487.7	77.6	154	275.0	1.79	2578
		1045	---	---	---	---	---	53.2	486.1	86.4	154			3200
		1160	---	---	---	---	---	59.2	487.3	87.4	154			3200
			1220	---	---	---	---	62.1	486.1	87.7	154			3200
		1395	---	---	---	1250	---	63.6	485.9	87.9	154			3200
			---	---	---	---	---	70.7	484.0	88.9	153			3200
			---	---	---	---	---	1630	81.9	479.8	90.4			151
59	435	---	---	---	---	---	---	23.0	504.9	75.2	139	344	2.3	2171
		895	---	---	---	---	---	47.4	505.7	85.3	139			2872
		995	---	---	---	---	---	52.8	506.7	86.3	139			2941
			1045	---	---	---	---	55.4	506.2	86.6	139			2977
		1200	---	---	---	1075	---	56.7	503.7	86.8	139			2994
			---	---	---	---	---	63.2	502.9	88.1	138			3073
			---	---	---	---	---	1405	73.3	498.2	89.2			137
60	380	---	---	---	---	---	---	20.3	510.1	72.1	128	431	2.85	1890
		795	---	---	---	---	---	42.7	512.9	83.4	128			2573
		890	---	---	---	---	---	47.7	511.8	84.7	128			2636
			935	---	---	---	---	50.1	511.7	85.1	128			2668
		1075	---	---	---	960	---	51.3	510.3	85.3	128			2684
			---	---	---	---	---	57.3	509.0	86.8	127			2754
			---	---	---	---	---	1260	66.8	506.3	88.4			126
61	340	---	---	---	---	---	---	18.2	511.2	70.7	117	493	3.1	1705
		725	---	---	---	---	---	38.7	509.7	82.7	117			2359
		810	---	---	---	---	---	43.3	510.5	84.1	117			2418
			850	---	---	---	---	45.5	511.2	84.5	117			2448
		980	---	---	---	875	---	46.6	508.6	84.7	117			2462
			---	---	---	---	---	52.1	507.7	86.4	116			2527
			---	---	---	---	---	1150	60.8	504.9	87.4			116
62	300	---	---	---	---	---	---	15.8	502.9	68.4	105	606	3.94	1510
		655	---	---	---	---	---	34.1	497.1	81.2	105			2165
		735	---	---	---	---	---	38.2	496.3	82.7	105			2221
			770	---	---	---	---	40.2	498.5	83.2	105			2249
		890	---	---	---	790	---	41.2	498.0	83.5	105			2262
			---	---	---	---	---	46.2	495.7	85.4	104			2320
			---	---	---	---	---	1045	54.1	494.4	86.7			104
63	276	---	---	---	---	---	---	14.7	508.6	66.2	101	677	4.51	1381
		610	---	---	---	---	---	32.4	507.2	80.2	101			2034
		685	---	---	---	---	---	36.3	506.0	81.7	101			2079
			720	---	---	---	---	38.2	506.6	82.2	101			2100
		830	---	---	---	740	---	39.2	505.9	82.6	101			2111
			---	---	---	---	---	44.0	506.2	83.8	101			2157
			---	---	---	---	---	980	51.6	502.8	86.0			100

Nota (\*) - VENTILAZIONE SOLO L.O. / FAN ONLY SIDE COMMUTATOR

Nota (°) - Regolazione di campo / Field weakening



Potenza eccitazione Excitation power (w) 2000	Tipo Size MGL C 200 K
Cost. tempo eccitaz. Field time constant (ms) 350	Ventilazione Ventilation IC 06
Massa del motore Mass of the motor (Kg) 510	
Momento d'inerzia rotore Rotor inertia moment (Kgm2) 0.8	

Avv.	Velocità nominale n/min a tensione nominale di armatura Rated speed (rev/min) at rated voltage							Potenza Power kW	Coppia vel. nomin. Torque at rated speed Nm	Rendimento Efficiency %	Circuito di armatura Armature circuit			Max giri Max. speed (°)
	220	400	440	460	470	520	600				Corrente Current Amp	Res. 115°C mOhm	Ind. mH	
64	248	---	---	---	---	---	---	13.4	516.0	64.1	95	772	5.3	1241
		555	---	---	---	---	---	30.0	516.2	78.9	95			1887
		625	---	---	---	---	---	33.7	514.9	80.6	95			1929
		660	---	---	---	---	---	35.5	513.6	81.3	94.9			1949
		680	---	---	---	---	---	36.4	511.2	81.6	94.9			1959
		765	---	---	---	---	---	41.0	511.8	83.3	94.6			2002
		900	---	---	---	---	---	48.1	510.4	85.1	94.2			2060
		65	510	---	---	---	---	---	26.7	499.9	77.6			86
570	---	---	---	---	---	---	30.0	502.6	79.3	86			1819	
605	---	---	---	---	---	---	31.7	500.4	80.2	85.9			1843	
620	---	---	---	---	---	---	32.5	500.6	80.5	85.9			1854	
700	---	---	---	---	---	---	36.6	499.3	82.1	85.7			1905	
830	---	---	---	---	---	---	43.1	495.9	84.2	85.3			1972	
66	460	---	---	---	---	---	---	24.1	500.3	76.3	79	1070	6.94	1595
		520	---	---	---	---	---	27.2	499.5	78.3	79			1641
		550	---	---	---	---	---	28.7	498.3	79.1	78.9			1662
		565	---	---	---	---	---	29.4	496.9	79.3	78.9			1673
		635	---	---	---	---	---	33.2	499.3	81.1	78.7			1718
		755	---	---	---	---	---	39.2	495.8	83.2	78.5			1777
		67	405	---	---	---	---	---	20.9	492.8	73.6			71
455	---	---	---	---	---	---	23.7	497.4	75.9	71			1516	
485	---	---	---	---	---	---	25.0	492.2	76.7	70.9			1534	
495	---	---	---	---	---	---	25.7	495.8	77.1	70.9			1542	
565	---	---	---	---	---	---	29.1	491.8	79.0	70.8			1579	
670	---	---	---	---	---	---	34.6	493.1	81.7	70.6			1627	
68	360	---	---	---	---	---	---	19.1	506.6	71.3	67	1560	9.93	1329
		410	---	---	---	---	---	21.7	505.4	73.6	67			1365
		435	---	---	---	---	---	23.0	504.9	74.6	67			1381
		445	---	---	---	---	---	23.7	508.6	75.4	66.9			1388
		510	---	---	---	---	---	26.9	503.7	77.4	66.8			1422
		605	---	---	---	---	---	32.0	505.1	80.1	66.6			1465
		69	335	---	---	---	---	---	18.0	513.1	70.9			63.5
380	---	---	---	---	---	---	20.4	512.6	73.0	63.5			1260	
400	---	---	---	---	---	---	21.7	518.0	74.3	63.5			1275	
415	---	---	---	---	---	---	22.3	513.1	74.8	63.4			1282	
470	---	---	---	---	---	---	25.3	514.0	76.9	63.3			1313	
560	---	---	---	---	---	---	30.2	515.0	79.6	63.2			1353	

Nota (\*) - VENTILAZIONE SOLO L.O. / FAN ONLY SIDE COMMUTATOR

Nota (°) - Regolazione di campo / Field weakening



Potenza eccitazione Excitation power (w) 2150	Tipo Size MGL C 200 S
Cost. tempo eccitaz. Field time constant (ms) 400	Ventilazione Ventilation IC 06
Massa del motore Mass of the motor (Kg) 560	
Momento d'inerzia rotore Rotor inertia moment (Kgm2) 0.88	

Avv.	Velocità nominale n/min a tensione nominale di armatura Rated speed (rev/min) at rated voltage							Potenza Power kW	Coppia vel. nomin. Torque at rated speed Nm	Rendimento Efficiency %	Circuito di armatura Armature circuit			Max giri Max. speed (°)
	220	400	440	460	470	520	600				Corrente Current Amp	Res. 115°C mOhm	Ind. mH	
48	1105	---	---	---	---	---	---	81.3	702.6	88.0	420	47.2	0.48	3200
		2115	---	---	---	---	---	155	699.8	92.3	420			3200
		2335	---	---	---	---	---	172	703.4	93.1	420			3200
			2450	---	---	---	---	179	697.7	93.1	418			3200
		2505	---	---	---	---	---	183	697.6	93.4	417			3200
			2785	---	---	---	---	200	685.8	93.6	411			3200
		49	1045	---	---	---	---	---	---	79.3	724.7			87.9
1995	---			---	---	---	---	152	727.6	92.7	410	3200		
2205	---			---	---	---	---	168	727.6	93.1	410	3200		
	2315			---	---	---	---	175	721.9	93.2	408	3200		
2365	---			---	---	---	---	178	718.7	93.1	407	3200		
	2630			---	---	---	---	196	711.7	93.8	402	3200		
3050	---			---	---	---	---	222	695.1	94.1	393	3200	*	
50	945	---	---	---	---	---	---	67.3	680.1	86.2	355	67.2	0.86	3200
		1820	---	---	---	---	---	130	682.1	91.5	355			3200
		2015	---	---	---	---	---	144	682.4	92.2	355			3200
			2110	---	---	---	---	150	678.9	92.1	354			3200
		2160	---	---	---	---	---	153	676.4	92.2	353			3200
			2400	---	---	---	---	169	672.4	93.1	349			3200
		2790	---	---	---	---	---	193	660.6	93.8	343			3200
51	845	---	---	---	---	---	---	67.0	757.2	85.8	355	70.9	0.93	3200
		1630	---	---	---	---	---	130	761.6	91.5	355			3200
		1810	---	---	---	---	---	144	759.7	92.2	355			3200
			1895	---	---	---	---	150	755.9	92.1	354			3200
		1940	---	---	---	---	---	153	753.1	92.2	353			3200
			2160	---	---	---	---	169	747.1	92.9	350			3200
		2510	---	---	---	---	---	193	734.3	93.5	344			3200
52	755	---	---	---	---	---	---	59.9	757.6	85.1	320	83.3	0.96	3200
		1465	---	---	---	---	---	116	756.1	90.6	320			3200
		1625	---	---	---	---	---	129	758.1	91.6	320			3200
			1705	---	---	---	---	135	756.1	92.0	319			3200
		1745	---	---	---	---	---	138	755.2	92.3	318			3200
			1940	---	---	---	---	152	748.2	92.5	316			3200
		2260	---	---	---	---	---	174	735.2	93.2	311			3200
53	675	---	---	---	---	---	---	54.7	773.8	83.7	297	101	1.09	2978
		1325	---	---	---	---	---	107	771.2	90.1	297			3200
		1470	---	---	---	---	---	119	773.0	91.1	297			3200
			1540	---	---	---	---	124	768.9	91.1	296			3200
		1575	---	---	---	---	---	127	770.0	91.3	296			3200
			1755	---	---	---	---	140	761.8	91.6	294			3200
		2045	---	---	---	---	---	162	756.5	93.1	290			3200
54	610	---	---	---	---	---	---	46.1	721.7	82.2	255	131	1.23	2801
		1205	---	---	---	---	---	91	721.2	89.2	255			3200
		1340	---	---	---	---	---	101	719.8	90.0	255			3200
			1405	---	---	---	---	106	720.4	90.7	254			3200
		1435	---	---	---	---	---	108	718.7	90.5	254			3200
			1600	---	---	---	---	120	716.2	91.2	253			3200
		1865	---	---	---	---	---	138	706.6	92.0	250			3200

Nota (\*) - VENTILAZIONE SOLO L.O. / FAN ONLY SIDE COMMUTATOR

Nota (°) - Regolazione di campo / Field weakening



Potenza eccitazione Excitation power (w) 2150	Tipo Size MGL C 200 S
Cost. tempo eccitaz. Field time constant (ms) 400	Ventilazione Ventilation IC 06
Massa del motore Mass of the motor (Kg) 560	
Momento d'inerzia rotore Rotor inertia moment (Kgm2) 0.88	

Avv.	Velocità nominale n/min a tensione nominale di armatura Rated speed (rev/min) at rated voltage							Potenza Power kW	Coppia vel. nomin. Torque at rated speed Nm	Rendimento Efficiency %	Circuito di armatura Armature circuit			Max giri Max. speed (°)
	220	400	440	460	470	520	600				Corrente Current Amp	Res. 115°C mOhm	Ind. mH	
55	560	---	---	---	---	---	---	44.7	762.2	81.9	248	137	1.57	2453
		1110	---	---	---	---	---	88.4	760.5	89.1	248			2809
		---	1235	---	---	---	---	98.2	759.3	90.0	248			2851
		---	---	1295	---	---	---	103	759.5	90.7	247			2876
		---	---	---	1325	---	---	105	756.7	90.4	247			2889
		---	---	---	---	1480	---	116	748.5	90.7	246			2945
		---	---	---	---	---	1725	134	741.8	91.9	243			3026
56	505	---	---	---	---	---	---	37.4	707.2	79.4	214	185.0	1.75	2535
		1020	---	---	---	---	---	75.1	703.1	87.7	214			3039
		---	1130	---	---	---	---	83.5	705.6	88.7	214			3094
		---	---	1190	---	---	---	87.5	702.2	88.9	214			3124
		---	---	---	1220	---	---	89.5	700.5	89.4	213			3139
		---	---	---	---	1360	---	99.5	698.6	90.3	212			3200
		---	---	---	---	---	1585	115	692.9	91.3	210			3200
57	470	---	---	---	---	---	---	33.8	686.7	78.4	196	213	2.15	2339
		945	---	---	---	---	---	68.3	690.2	87.1	196			3048
		---	1050	---	---	---	---	76.0	691.2	88.1	196			3108
		---	---	1105	---	---	---	79.7	688.8	88.4	196			3140
		---	---	---	1130	---	---	81.5	688.7	88.9	195			3156
		---	---	---	---	1265	---	90.7	684.7	89.9	194			3200
		---	---	---	---	---	1475	105	679.8	90.7	193			3200
58	415	---	---	---	---	---	---	25.7	591.4	75.9	154	305	2.14	2078
		855	---	---	---	---	---	52.8	589.7	85.7	154			2900
		---	950	---	---	---	---	58.8	591.1	86.8	154			2973
		---	---	1000	---	---	---	61.7	589.2	87.1	154			3011
		---	---	---	1025	---	---	63.1	587.9	87.2	154			3029
		---	---	---	---	1145	---	70.4	587.1	88.5	153			3113
		---	---	---	---	---	1340	81.7	582.2	89.6	152			3200
59	350	---	---	---	---	---	---	22.4	611.2	73.3	139	381	2.75	1742
		730	---	---	---	---	---	46.8	612.2	84.2	139			2497
		---	815	---	---	---	---	52.3	612.8	85.5	139			2562
		---	---	855	---	---	---	54.9	613.2	85.9	139			2594
		---	---	---	875	---	---	56.2	613.3	86.0	139			2610
		---	---	---	---	985	---	62.8	608.8	87.5	138			2682
		---	---	---	---	---	1150	73.1	607.0	88.9	137			2780
60	300	---	---	---	---	---	---	19.6	623.9	69.6	128	477	3.41	1507
		645	---	---	---	---	---	42.1	623.3	82.2	128			2235
		---	725	---	---	---	---	47.1	620.4	83.6	128			2295
		---	---	760	---	---	---	49.6	623.2	84.2	128			2324
		---	---	---	780	---	---	50.8	621.9	84.4	128			2339
		---	---	---	---	880	---	56.9	617.5	86.2	127			2403
		---	---	---	---	---	1030	66.4	615.6	87.1	127			2490
61	271	---	---	---	---	---	---	17.6	620.2	68.4	117	547	3.71	1356
		590	---	---	---	---	---	38.2	618.3	81.6	117			2048
		---	660	---	---	---	---	42.7	617.8	82.9	117			2104
		---	---	695	---	---	---	45.0	618.3	83.6	117			2132
		---	---	---	710	---	---	46.1	620.0	83.8	117			2145
		---	---	---	---	800	---	51.7	617.1	85.7	116			2204
		---	---	---	---	---	940	60.5	614.6	86.9	116			2283

Nota (\*) - VENTILAZIONE SOLO L.O. / FAN ONLY SIDE COMMUTATOR

Nota (°) - Regolazione di campo / Field weakening



Potenza eccitazione Excitation power (w) 2150	Tipo Size MGL C 200 S
Cost. tempo eccitaz. Field time constant (ms) 400	Ventilazione Ventilation IC 06
Massa del motore Mass of the motor (Kg) 560	
Momento d'inerzia rotore Rotor inertia moment (Kgm2) 0.88	

Avv.	Velocità nominale n/min a tensione nominale di armatura Rated speed (rev/min) at rated voltage							Potenza Power kW	Coppia vel. nomin. Torque at rated speed Nm	Rendimento Efficiency %	Circuito di armatura Armature circuit			Max giri Max. speed (°)
	220	400	440	460	470	520	600				Corrente Current Amp	Res. 115°C mOhm	Ind. mH	
62	239	---	---	---	---	---	---	15.1	603.3	65.4	105	672	4.71	1194
		530	---	---	---	---	---	33.6	605.4	80.0	105			1868
			595	---	---	---	---	37.7	605.1	81.6	105			1921
				630	---	---	---	39.7	601.8	82.2	105			1946
					645	---	---	40.7	602.6	82.5	105			1958
						725	---	45.7	601.9	83.7	105			2012
							855	53.7	599.8	86.1	104			2083
63		490	---	---	---	---	---	31.8	619.7	78.7	101	750.0	5.39	1761
			555	---	---	---	---	35.7	614.3	80.3	101			1803
				585	---	---	---	37.7	615.4	81.1	101			1823
					600	---	---	38.6	614.3	81.3	101			1832
						675	---	43.5	615.4	82.8	101			1875
							800	51.1	610.0	85.2	100			1931
64		450	---	---	---	---	---	29.4	623.9	77.4	95	856	6.34	1627
			505	---	---	---	---	33.1	625.9	79.2	95			1667
				535	---	---	---	34.9	622.9	79.9	94.9			1686
					550	---	---	35.8	621.6	80.3	94.9			1694
						620	---	40.4	622.2	82.0	94.7			1734
							735	47.6	618.4	84.1	94.3			1786
65		410	---	---	---	---	---	26.0	605.6	75.6	86	1020	7.16	1530
			460	---	---	---	---	29.4	610.3	77.7	86			1578
				490	---	---	---	31.1	606.1	78.7	85.9			1600
					500	---	---	31.9	609.2	79.0	85.9			1611
						570	---	36.0	603.1	80.8	85.7			1659
							675	42.6	602.7	83.1	85.4			1721
66		370	---	---	---	---	---	23.5	606.5	74.4	79	1180	8.3	1372
			420	---	---	---	---	26.6	604.8	76.5	79			1415
				445	---	---	---	28.1	603.0	77.4	78.9			1435
					455	---	---	28.9	606.5	77.9	78.9			1445
						515	---	32.7	606.3	79.8	78.8			1487
							615	38.7	600.9	82.2	78.5			1542
67		325	---	---	---	---	---	20.3	596.5	71.5	71	1480	10.5	1279
			365	---	---	---	---	23.1	604.4	73.9	71			1316
				390	---	---	---	24.4	597.4	74.7	71			1333
					400	---	---	25.1	599.2	75.3	70.9			1341
						455	---	28.5	598.1	77.4	70.8			1376
							545	34.0	595.7	80.3	70.6			1421
68		287	---	---	---	---	---	18.4	612.2	68.7	67	1730	11.9	1144
			330	---	---	---	---	21.1	610.6	71.6	67			1178
				350	---	---	---	22.4	611.2	72.7	67			1194
					360	---	---	23.0	610.1	73.1	66.9			1201
						410	---	26.3	612.6	75.7	66.8			1233
							490	31.4	611.9	78.5	66.7			1273

Nota (\*) - VENTILAZIONE SOLO L.O. / FAN ONLY SIDE COMMUTATOR

Nota (°) - Regolazione di campo / Field weakening



Potenza eccitazione Excitation power (w)	2150	Tipo Size MGL C 200 S Ventilazione Ventilation IC 06
Cost. tempo eccitaz. Field time constant (ms)	400	
Massa del motore Mass of the motor (Kg)	560	
Momento d'inerzia rotore Rotor inertia moment (Kgm2)	0.88	

Avv.	Velocità nominale n/min a tensione nominale di armatura Rated speed (rev/min) at rated voltage							Potenza Power	Coppia vel. nomin. Torque at rated speed Nm	Rendimento Efficiency	Circuito di armatura Armature circuit			Max giri Max. speed (°)
	220	400	440	460	470	520	600	kW	%	Corrente Current Amp	Res. 115°C mOhm	Ind. mH		
69		264	---	---	---	---	---	17.3	625.8	68.1	63.5	1870	14.5	1052
			300	---	---	---	---	19.8	630.3	70.9	63.5			1084
				320	---	---	---	21	626.7	71.9	63.5			1098
					330	---	---	21.6	625.0	72.5	63.4			1105
						380	---	24.7	620.7	74.9	63.4			1134
							455	29.6	621.2	78.1	63.2			1172

Nota (\*) - VENTILAZIONE SOLO L.O. / FAN ONLY SIDE COMMUTATOR

Nota (°) - Regolazione di campo / Field weakening





Potenza eccitazione Excitation power (w) 2300	Tipo Size MGL C 200 M
Cost. tempo eccitaz. Field time constant (ms) 450	Ventilazione Ventilation IC 06
Massa del motore Mass of the motor (Kg) 605	
Momento d'inerzia rotore Rotor inertia moment (Kgm2) 1.03	

Avv.	Velocità nominale n/min a tensione nominale di armatura Rated speed (rev/min) at rated voltage							Potenza Power kW	Coppia vel. nomin. Torque at rated speed Nm	Rendimento Efficiency %	Circuito di armatura Armature circuit			Max giri Max. speed (°)	
	220	400	440	460	470	520	600				Corrente Current Amp	Res. 115°C mOhm	Ind. mH		
46	1045	---	---	---	---	---	---	90.3	825.2	88.3	465	42.4	0.5	3200	
		1995	---	---	---	---	---	172	823.3	92.5	465			3200	
		2205	---	---	---	---	---	---	190	822.8	92.9			465	3200
			2310	---	---	---	---	---	199	822.6	93.4			463	3200
		2365	---	---	---	---	---	---	203	819.7	93.7			461	3200
			2625	---	---	---	---	---	222	807.6	93.8			455	3200
		3050	---	---	---	---	---	252	789.0	94.6	444			3200	
		47	1005	---	---	---	---	---	---	88.1	837.1			88.2	454
1925	---			---	---	---	---	168	833.4	92.5	454	3200			
2125	---			---	---	---	---	---	186	835.8	93.1	454	3200		
	2230			---	---	---	---	---	194	830.7	93.3	452	3200		
2280	---			---	---	---	---	---	198	829.3	93.6	450	3200		
	2535			---	---	---	---	---	217	817.4	94.0	444	3200		
2940	---			---	---	---	---	246	799.0	94.7	433	3200			
48	965			---	---	---	---	---	---	80.9	800.6	87.6	420	50.8	0.54
		1850	---	---	---	---	---	155	800.1	92.3	420	3200			
		2045	---	---	---	---	---	---	171	798.5	92.5	420	3200		
			2145	---	---	---	---	---	179	796.9	93.1	418	3200		
		2195	---	---	---	---	---	---	182	791.8	92.9	417	3200		
			2440	---	---	---	---	---	201	786.6	93.8	412	3200		
		2830	---	---	---	---	---	228	769.3	94.1	404	3200			
		49	910	---	---	---	---	---	---	78.8	826.9	87.4	410		
1745	---			---	---	---	---	151	826.3	92.1	410	3200			
1930	---			---	---	---	---	---	167	826.3	92.6	410	3200		
	2025			---	---	---	---	---	175	825.2	93.2	408	3200		
2070	---			---	---	---	---	---	178	821.1	93.1	407	3200		
	2305			---	---	---	---	---	196	812.0	93.5	403	3200		
2675	---			---	---	---	---	223	796.1	94.1	395	3200			
50	820			---	---	---	---	---	---	66.8	777.9	85.5	355	72.5	0.97
		1590	---	---	---	---	---	129	774.8	90.8	355	3200			
		1760	---	---	---	---	---	---	143	775.9	91.5	355	3200		
			1845	---	---	---	---	---	150	776.4	92.1	354	3200		
		1890	---	---	---	---	---	---	153	773.0	92.2	353	3200		
			2105	---	---	---	---	---	169	766.7	92.9	350	3200		
		2445	---	---	---	---	---	193	753.8	93.2	345	3200			
		51	735	---	---	---	---	---	---	66.4	862.7	85.0	355		
1425	---			---	---	---	---	129	864.5	90.8	355	3200			
1580	---			---	---	---	---	---	143	864.3	91.5	355	3200		
	1660			---	---	---	---	---	150	862.9	92.1	354	3200		
1695	---			---	---	---	---	---	153	862.0	92.2	353	3200		
	1890			---	---	---	---	---	169	853.9	92.9	350	3200		
2195	---			---	---	---	---	193	839.6	93.2	345	3200			
52	655			---	---	---	---	---	---	59.4	866.0	84.4	320	89.8	1.08
		1280	---	---	---	---	---	116	865.4	90.6	320	3200			
		1420	---	---	---	---	---	---	128	860.8	90.9	320	3200		
			1490	---	---	---	---	---	134	858.8	91.3	319	3200		
		1525	---	---	---	---	---	---	137	857.9	91.4	319	3200		
			1700	---	---	---	---	---	152	853.8	92.5	316	3200		
		1975	---	---	---	---	---	174	841.3	92.9	312	3200			

Nota (\*) - VENTILAZIONE SOLO L.O. / FAN ONLY SIDE COMMUTATOR

Nota (°) - Regolazione di campo / Field weakening



Potenza eccitazione Excitation power (w)	2300	Tipo Size MGL C 200 M Ventilazione Ventilation IC 06
Cost. tempo eccitaz. Field time constant (ms)	450	
Massa del motore Mass of the motor (Kg)	605	
Momento d'inerzia rotore Rotor inertia moment (Kgm2)	1.03	

Avv.	Velocità nominale n/min a tensione nominale di armatura Rated speed (rev/min) at rated voltage							Potenza Power kW	Coppia vel. nomin. Torque at rated speed Nm	Rendimento Efficiency %	Circuito di armatura Armature circuit			Max giri Max. speed (°)	
	220	400	440	460	470	520	600				Corrente Current Amp	Res. 115°C mOhm	Ind. mH		
53	585	---	---	---	---	---	---	54.1	883.1	82.8	297	109	1.23	2698	
		1155	---	---	---	---	---	107	884.7	90.1	297			3113	
		1285	---	---	---	---	---	---	118	876.9	90.3			297	3162
			1345	---	---	---	---	---	124	880.4	91.1			296	3191
		1380	---	---	---	---	---	---	127	878.8	91.3			296	3200
			1535	---	---	---	---	---	140	871.0	91.6			294	3200
		1790	---	---	---	---	---	---	162	864.2	92.8			291	3200
		54	530	---	---	---	---	---	---	45.5	819.8			81.1	255
1050	---			---	---	---	---	90.6	824.0	88.8	255	2936			
1170	---			---	---	---	---	---	101	824.3	90.0	255	2985		
	1225			---	---	---	---	---	105	818.5	89.9	254	3013		
1255	---			---	---	---	---	---	108	821.8	90.5	254	3026		
	1400			---	---	---	---	---	120	818.5	91.2	253	3087		
1635	---			---	---	---	---	---	138	806.0	91.6	251	3174		
55	485			---	---	---	---	---	---	44.1	868.3	80.8	248	148	1.77
		970	---	---	---	---	---	88.0	866.3	88.7	248	2545			
		1080	---	---	---	---	---	---	97.7	863.9	89.5	248	2585		
			1130	---	---	---	---	---	102	862.0	89.8	247	2608		
		1160	---	---	---	---	---	---	105	864.4	90.4	247	2619		
			1295	---	---	---	---	---	116	855.4	90.7	246	2670		
		1510	---	---	---	---	---	---	134	847.4	91.9	243	2743		
		56	440	---	---	---	---	---	---	36.8	798.7	78.2	214		
890	---			---	---	---	---	74.6	800.4	87.1	214	2753			
990	---			---	---	---	---	---	83.0	800.6	88.1	214	2804		
	1035			---	---	---	---	---	87.1	803.6	88.5	214	2832		
1060	---			---	---	---	---	---	89.1	802.7	89.0	213	2846		
	1185			---	---	---	---	---	99.1	798.6	89.9	212	2907		
1385	---			---	---	---	---	---	115	792.9	90.8	211	2993		
57	405			---	---	---	---	---	---	33.2	782.8	77.0	196	230	2.43
		825	---	---	---	---	---	67.8	784.8	86.5	196	2758			
		915	---	---	---	---	---	---	75.5	787.9	87.5	196	2815		
			965	---	---	---	---	---	79.2	783.7	87.8	196	2845		
		985	---	---	---	---	---	---	81.1	786.2	88.5	195	2859		
			1105	---	---	---	---	---	90.3	780.4	89.1	195	2925		
		1290	---	---	---	---	---	---	105	777.3	90.7	193	3016		
		58	355	---	---	---	---	---	---	25.2	677.9	74.4	154		
740	---			---	---	---	---	52.3	674.9	84.9	154	2615			
825	---			---	---	---	---	---	58.4	676.0	86.2	154	2685		
	870			---	---	---	---	---	61.3	672.8	86.5	154	2720		
890	---			---	---	---	---	---	62.8	673.8	86.8	154	2737		
	1000			---	---	---	---	---	70.0	668.5	88.0	153	2814		
1170	---			---	---	---	---	---	81.5	665.2	89.4	152	2918		
59	299			---	---	---	---	---	---	21.9	699.4	71.6	139	411	3.11
		635	---	---	---	---	---	46.4	697.8	83.5	139	2258			
		705	---	---	---	---	---	---	51.8	701.6	84.7	139	2320		
			745	---	---	---	---	---	54.5	698.6	85.2	139	2351		
		765	---	---	---	---	---	---	55.8	696.5	85.4	139	2366		
			855	---	---	---	---	---	62.4	696.9	87.0	138	2433		
		1005	---	---	---	---	---	---	72.8	691.7	88.6	137	2523		

Nota (\*) - VENTILAZIONE SOLO L.O. / FAN ONLY SIDE COMMUTATOR

Nota (°) - Regolazione di campo / Field weakening



Potenza eccitazione Excitation power (w) 2300	Tipo Size MGL C 200 M
Cost. tempo eccitaz. Field time constant (ms) 450	Ventilazione Ventilation IC 06
Massa del motore Mass of the motor (Kg) 605	
Momento d'inerzia rotore Rotor inertia moment (Kgm2) 1.03	

Avv.	Velocità nominale n/min a tensione nominale di armatura Rated speed (rev/min) at rated voltage							Potenza Power kW	Coppia vel. nomin. Torque at rated speed Nm	Rendimento Efficiency %	Circuito di armatura Armature circuit			Max giri Max. speed (°)
	220	400	440	460	470	520	600				Corrente Current Amp	Res. 115°C mOhm	Ind. mH	
60	257	---	---	---	---	---	---	19.1	709.7	67.8	128	514	3.85	1284
		560	---	---	---	---	---	41.6	709.4	81.3	128			2020
		630	---	---	---	---	---	46.6	706.3	82.7	128			2077
		660	---	---	---	---	---	49.1	710.4	83.4	128			2105
		680	---	---	---	---	---	50.3	706.4	83.6	128			2119
		765	---	---	---	---	---	56.4	704.0	85.4	127			2179
		900	---	---	---	---	---	66.1	701.3	86.7	127			2260
61	231	---	---	---	---	---	---	17	706.9	66.4	117	589.0	4.2	1153
		510	---	---	---	---	---	37.7	705.9	80.6	117			1851
		570	---	---	---	---	---	42.3	708.7	82.2	117			1905
		600	---	---	---	---	---	44.5	708.2	82.7	117			1930
		620	---	---	---	---	---	45.6	702.3	82.9	117			1943
		695	---	---	---	---	---	51.2	703.5	84.9	116			1998
		820	---	---	---	---	---	60.1	699.9	86.4	116			2072
62	460	---	---	---	---	---	---	33.1	687.1	78.8	105	724	5.32	1681
		515	---	---	---	---	---	37.2	689.8	80.5	105			1731
		545	---	---	---	---	---	39.2	686.8	81.2	105			1755
		560	---	---	---	---	---	40.2	685.5	81.5	105			1766
		630	---	---	---	---	---	45.3	686.6	83.0	105			1817
		745	---	---	---	---	---	53.3	683.2	85.4	104			1883
		63	425	---	---	---	---	---	---	31.3	703.3			77.5
480	---	---		---	---	---	35.2	700.3	79.2	101	1628			
505	---	---		---	---	---	37.2	703.4	80.1	101	1647			
520	---	---		---	---	---	38.2	701.5	80.5	101	1656			
585	---	---		---	---	---	43.0	701.9	81.9	101	1696			
695	---	---		---	---	---	50.7	696.6	84.5	100	1749			
64	390	---		---	---	---	---	---	28.9	707.6	76.1	95	923	7.18
440		---	---	---	---	---	32.6	707.5	78.0	95	1502			
460		---	---	---	---	---	34.4	714.1	78.8	94.9	1519			
475		---	---	---	---	---	35.3	709.7	79.1	94.9	1528			
535		---	---	---	---	---	39.9	712.2	81.0	94.7	1565			
635		---	---	---	---	---	47.2	709.8	83.3	94.4	1614			
65		350	---	---	---	---	---	---	25.5	695.7	74.1	86		
400	---		---	---	---	---	28.9	689.9	76.4	86	1425			
420	---		---	---	---	---	30.6	695.7	77.4	85.9	1446			
435	---		---	---	---	---	31.4	689.3	77.8	85.9	1456			
490	---		---	---	---	---	35.5	691.8	79.7	85.7	1502			
585	---		---	---	---	---	42.1	687.2	82.2	85.4	1561			
66	315		---	---	---	---	---	---	23.0	697.3	72.8	79	1280	9.38
360		---	---	---	---	---	26.1	692.3	75.1	79	1273			
380		---	---	---	---	---	27.6	693.6	76.0	78.9	1292			
390		---	---	---	---	---	28.4	695.4	76.6	78.9	1301			
445		---	---	---	---	---	32.2	691.0	78.6	78.8	1341			
530		---	---	---	---	---	38.3	690.1	81.2	78.6	1393			

Nota (\*) - VENTILAZIONE SOLO L.O. / FAN ONLY SIDE COMMUTATOR

Nota (°) - Regolazione di campo / Field weakening



Potenza eccitazione Excitation power (w) 2300	Tipo Size MGL C 200 M
Cost. tempo eccitaz. Field time constant (ms) 450	Ventilazione Ventilation IC 06
Massa del motore Mass of the motor (Kg) 605	
Momento d'inerzia rotore Rotor inertia moment (Kgm2) 1.03	

Avv.	Velocità nominale n/min a tensione nominale di armatura Rated speed (rev/min) at rated voltage							Potenza Power kW	Coppia vel. nomin. Torque at rated speed Nm	Rendimento Efficiency %	Circuito di armatura Armature circuit			Max giri Max. speed (°)	
	220	400	440	460	470	520	600				Corrente Current Amp	Res. 115°C mOhm	Ind. mH		
67		276	---	---	---	---	---	19.8	685.1	69.7	71	1600	11.9		
			315	---	---	---	---	22.5	682.1	72.0	71				1152
				335	---	---	---	23.9	681.3	73.2	71				1188
					345	---	---	24.6	680.9	73.8	70.9				1205
						390	---	28	685.6	76.1	70.8				1212
							470	33.5	680.6	79.0	70.7				1246
															1289
68		244	---	---	---	---	---	17.9	700.5	66.8	67	1870.0	13.4		
			280	---	---	---	---	20.5	699.1	69.5	67				1026
				298	---	---	---	21.8	698.6	70.7	67				1060
					305	---	---	22.5	704.5	71.6	66.9				1075
						350	---	25.7	701.2	73.9	66.9				1082
							425	30.9	694.3	77.2	66.7				1113
															1151
69		225	---	---	---	---	---	16.8	713.0	66.1	63.5	2020	16.5		
			258	---	---	---	---	19.3	714.3	69.1	63.5				942
				275	---	---	---	20.5	711.9	70.2	63.5				973
					283	---	---	21.1	712.0	70.7	63.5				987
						325	---	24.2	711.1	73.4	63.4				994
							390	29.1	712.5	76.7	63.2				1022
															1057

Nota (\*) - VENTILAZIONE SOLO L.O. / FAN ONLY SIDE COMMUTATOR

Nota (°) - Regolazione di campo / Field weakening



Potenza eccitazione Excitation power (w)	2500	Tipo Size	MGL C 200 L
Cost. tempo eccitaz. Field time constant (ms)	490	Ventilazione Ventilation	IC 06
Massa del motore Mass of the motor (Kg)	660		
Momento d'inerzia rotore Rotor inertia moment (Kgm2)	1.2		

Avv.	Velocità nominale n/min a tensione nominale di armatura Rated speed (rev/min) at rated voltage							Potenza Power kW	Coppia vel. nomin. Torque at rated speed Nm	Rendimento Efficiency %	Circuito di armatura Armature circuit			Max giri Max. speed (°)
	220	400	440	460	470	520	600				Corrente Current Amp	Res. 115°C mOhm	Ind. mH	
45	980	---	---	---	---	---	---	94.7	922.8	88.4	487	40.5	0.44	3200
		1870	---	---	---	---	---	181	924.3	92.9	487			3200
		---	2070	---	---	---	---	200	922.6	93.3	487			3200
		---	---	2170	---	---	---	209	919.7	93.3	487			3200
		---	---	---	2215	---	---	214	922.6	93.5	487			3200
		---	---	---	---	2465	---	238	922.0	94.0	487			3200
		---	---	---	---	---	2860	276	921.5	94.5	487			3200
		---	---	---	---	---	---	---	---	---	---			---
46	900	---	---	---	---	---	---	89.7	951.7	87.7	465	46.2	0.57	3200
		1725	---	---	---	---	---	172	952.2	92.5	465			3200
		---	1905	---	---	---	---	190	952.4	92.9	465			3200
		---	---	2000	---	---	---	198	945.4	93.0	463			3200
		---	---	---	2045	---	---	202	943.3	93.0	462			3200
		---	---	---	---	2275	---	222	931.8	93.6	456			3200
		---	---	---	---	---	2640	253	915.1	94.3	447			3200
		---	---	---	---	---	---	---	---	---	---			---
47	865	---	---	---	---	---	---	87.5	966.0	87.6	454	47.6	0.63	3200
		1660	---	---	---	---	---	168	966.4	92.5	454			3200
		---	1840	---	---	---	---	186	965.3	93.1	454			3200
		---	---	1925	---	---	---	194	962.4	93.3	452			3200
		---	---	---	1970	---	---	198	959.8	93.4	451			3200
		---	---	---	---	2190	---	217	946.2	93.8	445			3200
		---	---	---	---	---	2545	247	926.8	94.4	436			3200
		---	---	---	---	---	---	---	---	---	---			---
48	830	---	---	---	---	---	---	80.3	923.9	86.9	420	55.3	0.62	3200
		1600	---	---	---	---	---	154	919.1	91.7	420			3200
		---	1770	---	---	---	---	171	922.6	92.5	420			3200
		---	---	1855	---	---	---	178	916.3	92.6	418			3200
		---	---	---	1895	---	---	182	917.1	92.9	417			3200
		---	---	---	---	2110	---	201	909.7	93.6	413			3200
		---	---	---	---	---	2450	229	892.6	94.0	406			3200
		---	---	---	---	---	---	---	---	---	---			---
49	785	---	---	---	---	---	---	78.2	951.3	86.7	410	57.9	0.73	3200
		1510	---	---	---	---	---	151	954.9	92.1	410			3200
		---	1670	---	---	---	---	167	954.9	92.6	410			3200
		---	---	1750	---	---	---	174	949.5	92.7	408			3200
		---	---	---	1790	---	---	178	949.6	92.8	408			3200
		---	---	---	---	1995	---	196	938.2	93.5	403			3200
		---	---	---	---	---	2315	224	924.0	94.3	396			3200
		---	---	---	---	---	---	---	---	---	---			---
50	705	---	---	---	---	---	---	66.1	895.3	84.6	355	79.1	1.11	3200
		1370	---	---	---	---	---	129	899.2	90.8	355			3200
		---	1520	---	---	---	---	143	898.4	91.5	355			3200
		---	---	1595	---	---	---	149	892.1	91.5	354			3200
		---	---	---	1630	---	---	153	896.3	92.2	353			3200
		---	---	---	---	1815	---	169	889.2	92.6	351			3200
		---	---	---	---	---	2115	194	875.9	93.4	346			3200
		---	---	---	---	---	---	---	---	---	---			---
51	630	---	---	---	---	---	---	65.7	995.9	84.1	355	83.5	1.2	2905
		1230	---	---	---	---	---	128	993.7	90.1	355			3200
		---	1365	---	---	---	---	142	993.4	90.9	355			3200
		---	---	1430	---	---	---	149	995.0	91.5	354			3200
		---	---	---	1465	---	---	152	990.8	91.6	353			3200
		---	---	---	---	1630	---	168	984.2	92.0	351			3200
		---	---	---	---	---	1900	194	975.0	93.4	346			3200
		---	---	---	---	---	---	---	---	---	---			---

Nota (\*) - VENTILAZIONE SOLO L.O. / FAN ONLY SIDE COMMUTATOR

Nota (°) - Regolazione di campo / Field weakening



Potenza eccitazione Excitation power (w) 2500	Tipo Size MGL C 200 L
Cost. tempo eccitaz. Field time constant (ms) 490	Ventilazione Ventilation IC 06
Massa del motore Mass of the motor (Kg) 660	
Momento d'inerzia rotore Rotor inertia moment (Kgm2) 1.2	

Avv.	Velocità nominale n/min a tensione nominale di armatura Rated speed (rev/min) at rated voltage							Potenza Power kW	Coppia vel. nomin. Torque at rated speed Nm	Rendimento Efficiency %	Circuito di armatura Armature circuit			Max giri Max. speed (°)	
	220	400	440	460	470	520	600				Corrente Current Amp	Res. 115°C mOhm	Ind. mH		
52	565	---	---	---	---	---	---	58.7	992.1	83.4	320	97.8	1.24	2689	
		1105	---	---	---	---	---	115	993.8	89.8	320			3120	
		1225	---	---	---	---	---	---	128	997.8	90.9			320	3171
			1285	---	---	---	---	---	134	995.8	91.3			319	3200
		1315	---	---	---	---	---	---	137	994.9	91.4			319	3200
			1470	---	---	---	---	---	151	980.9	91.9			316	3200
		1710	---	---	---	---	---	---	174	971.7	92.7			313	3200
		53	500	---	---	---	---	---	---	53.3	1018			81.6	297
995	---			---	---	---	---	106	1017	89.2	297	2806			
1105	---			---	---	---	---	---	118	1020	90.3	297	2853		
	1160			---	---	---	---	---	123	1013	90.3	296	2880		
1190	---			---	---	---	---	---	126	1011	90.6	296	2893		
	1325			---	---	---	---	---	140	1009	91.6	294	2953		
1545	---			---	---	---	---	---	162	1001	92.5	292	3036		
54	450			---	---	---	---	---	---	44.8	950.7	79.9	255	153	1.59
		905	---	---	---	---	---	89.9	948.6	88.1	255	2634			
		1005	---	---	---	---	---	---	100.0	950.2	89.1	255	2680		
			1055	---	---	---	---	---	105	950.4	89.5	255	2705		
		1080	---	---	---	---	---	---	107	946.1	89.6	254	2717		
			1210	---	---	---	---	---	119	939.2	90.5	253	2773		
		1410	---	---	---	---	---	---	138	934.6	91.6	251	2850		
		55	415	---	---	---	---	---	---	43.4	998.6	79.5	248		
835	---			---	---	---	---	87.3	998.4	88.0	248	2277			
930	---			---	---	---	---	---	97.1	997.0	89.0	248	2314		
	975			---	---	---	---	---	102	999.0	89.4	248	2335		
1000	---			---	---	---	---	---	104	993.1	89.6	247	2345		
	1115			---	---	---	---	---	116	993.5	90.7	246	2391		
1300	---			---	---	---	---	---	134	984.3	91.5	244	2455		
56	370			---	---	---	---	---	---	36.1	931.7	76.7	214	217	2.26
		765	---	---	---	---	---	73.9	922.5	86.3	214	2461			
		850	---	---	---	---	---	---	82.4	925.7	87.5	214	2510		
			895	---	---	---	---	---	86.4	921.9	87.8	214	2535		
		915	---	---	---	---	---	---	88.5	923.6	88.4	213	2548		
			1025	---	---	---	---	---	98.6	918.6	89.0	213	2603		
		1195	---	---	---	---	---	---	114	911.0	90.0	211	2680		
		57	340	---	---	---	---	---	---	32.5	912.8	75.4	196		
705	---			---	---	---	---	67.2	910.2	85.7	196	2464			
790	---			---	---	---	---	---	74.9	905.4	86.9	196	2517		
	830			---	---	---	---	---	78.6	904.3	87.2	196	2545		
850	---			---	---	---	---	---	80.5	904.4	87.4	196	2558		
	950			---	---	---	---	---	89.8	902.7	88.6	195	2618		
1115	---			---	---	---	---	---	104	890.7	89.8	193	2700		
58	300			---	---	---	---	---	---	24.6	783.0	72.6	154	358	2.77
		635	---	---	---	---	---	51.8	779.0	84.1	154	2327			
		710	---	---	---	---	---	---	57.8	777.4	85.3	154	2393		
			745	---	---	---	---	---	60.8	779.3	85.8	154	2425		
		765	---	---	---	---	---	---	62.2	776.4	85.9	154	2440		
			860	---	---	---	---	---	69.5	771.7	87.4	153	2511		
		1005	---	---	---	---	---	---	81.1	770.6	88.9	152	2606		

Nota (\*) - VENTILAZIONE SOLO L.O. / FAN ONLY SIDE COMMUTATOR

Nota (°) - Regolazione di campo / Field weakening



Potenza eccitazione Excitation power (w) 2500	Tipo Size MGL C 200 L
Cost. tempo eccitaz. Field time constant (ms) 490	Ventilazione Ventilation IC 06
Massa del motore Mass of the motor (Kg) 660	
Momento d'inerzia rotore Rotor inertia moment (Kgm2) 1.2	

Avv.	Velocità nominale n/min a tensione nominale di armatura Rated speed (rev/min) at rated voltage							Potenza Power kW	Coppia vel. nomin. Torque at rated speed Nm	Rendimento Efficiency %	Circuito di armatura Armature circuit			Max giri Max. speed (°)				
	220	400	440	460	470	520	600				Corrente Current Amp	Res. 115°C mOhm	Ind. mH					
59	251	---	---	---	---	---	---	21.2	806.6	69.3	139	448	3.56	1255				
		540	---	---	---	---	---	45.8	809.9	82.4	139			2015				
		605	---	---	---	---	---	51.2	808.1	83.7	139			2074				
		640	---	---	---	---	---	53.9	804.2	84.3	139			2103				
		655	---	---	---	---	---	55.2	804.8	84.5	139			2116				
		735	---	---	---	---	---	61.9	804.2	86.3	138			2178				
		865	---	---	---	---	---	72.4	799.3	87.4	138			2262				
		60	214	---	---	---	---	---	---	18	821.1			65.3	128	561.0	4.41	1071
480	---			---	---	---	---	41.0	815.7	80.1	128	1801						
535	---			---	---	---	---	46.0	821.1	81.7	128	1856						
565	---			---	---	---	---	48.5	819.7	82.4	128	1882						
580	---			---	---	---	---	49.7	818.3	82.6	128	1894						
655	---			---	---	---	---	55.8	813.5	84.5	127	1950						
770	---			---	---	---	---	65.5	812.3	86.0	127	2025						
61	435			---	---	---	---	---	---	37.1	814.4	79.3	117	642	4.8			1650
		490	---	---	---	---	---	41.6	810.7	80.8	117	1701						
		515	---	---	---	---	---	43.9	814.0	81.6	117	1725						
		530	---	---	---	---	---	45.0	810.8	81.8	117	1736						
		595	---	---	---	---	---	50.7	813.7	83.3	117	1788						
		705	---	---	---	---	---	59.6	807.3	85.6	116	1857						
		62	390	---	---	---	---	---	---	32.4	793.3	77.1	105			790	6.09	1492
				440	---	---	---	---	---	36.6	794.3	79.2	105					1539
465	---			---	---	---	---	38.6	792.7	79.9	105	1562						
475	---			---	---	---	---	39.6	796.1	80.2	105	1572						
540	---			---	---	---	---	44.7	790.5	81.9	105	1619						
635	---			---	---	---	---	52.7	792.5	84.5	104	1681						
63	360			---	---	---	---	---	---	30.6	811.7	75.7	101	882	6.98			1412
				405	---	---	---	---	---	34.6	815.8	77.9	101					1450
		430	---	---	---	---	---	36.5	810.6	78.6	101	1468						
		440	---	---	---	---	---	37.5	813.9	79.0	101	1476						
		500	---	---	---	---	---	42.4	809.8	80.7	101	1514						
		595	---	---	---	---	---	50.1	804.1	83.5	100	1563						
		64	330	---	---	---	---	---	---	28.2	816.0	74.2	95			1010	8.22	1298
				370	---	---	---	---	---	31.9	823.3	76.3	95					1335
395	---			---	---	---	---	33.8	817.1	77.4	94.9	1351						
405	---			---	---	---	---	34.7	818.2	77.8	94.9	1359						
460	---			---	---	---	---	39.3	815.8	79.8	94.7	1394						
545	---			---	---	---	---	46.6	816.5	82.3	94.4	1439						
65	297			---	---	---	---	---	---	24.9	800.6	72.4	86	1200	9.27			1223
				335	---	---	---	---	---	28.2	803.9	74.5	86					1268
		355	---	---	---	---	---	29.9	804.3	75.7	85.9	1288						
		370	---	---	---	---	---	30.7	792.3	76.0	85.9	1298						
		420	---	---	---	---	---	34.9	793.5	78.2	85.8	1341						
		500	---	---	---	---	---	41.5	792.6	80.9	85.5	1397						

Nota (\*) - VENTILAZIONE SOLO L.O. / FAN ONLY SIDE COMMUTATOR

Nota (°) - Regolazione di campo / Field weakening





Potenza eccitazione Excitation power (w)	2500	Tipo Size	MGL C 200 L
Cost. tempo eccitaz. Field time constant (ms)	490	Ventilazione Ventilation	IC 06
Massa del motore Mass of the motor (Kg)	660		
Momento d'inerzia rotore Rotor inertia moment (Kgm <sup>2</sup> )	1.2		

Avv.	Velocità nominale n/min a tensione nominale di armatura Rated speed (rev/min) at rated voltage							Potenza Power kW	Coppia vel. nomin. Torque at rated speed Nm	Rendimento Efficiency %	Circuito di armatura Armature circuit			Max giri Max. speed (°)
	220	400	440	460	470	520	600				Corrente Current Amp	Res. 115°C mOhm	Ind. mH	
66		267	---	---	---	---	---	22.3	797.6	70.6	79	1390	10.7	
			305	---	---	---	---	25.4	795.3	73.1	79			
				325	---	---	---	26.9	790.4	74.0	79			
					330	---	---	27.7	801.6	74.7	78.9			
						380	---	31.5	791.6	76.9	78.8			
							450	37.7	800.0	79.9	78.6			
67		231	---	---	---	---	---	19.1	789.6	67.3	71	1740.0	13.6	
			264	---	---	---	---	21.9	792.2	70.1	71			
				281	---	---	---	23.3	791.8	71.3	71			
					289	---	---	23.9	789.7	71.7	70.9			
						330	---	27.4	792.9	74.3	70.9			
							400	32.9	785.4	77.6	70.7			
68		203	---	---	---	---	---	17.2	809.1	64.2	67	2040	15.4	
			234	---	---	---	---	19.8	808.0	67.2	67			
				250	---	---	---	21.1	806.0	68.5	67			
					258	---	---	21.8	806.9	69.2	67			
						297	---	25	803.8	71.9	66.9			
							360	30.2	801.1	75.5	66.7			

Nota (\*) - VENTILAZIONE SOLO L.O. / FAN ONLY SIDE COMMUTATOR

Nota (°) - Regolazione di campo / Field weakening



Potenza eccitazione Excitation power (w) 2900	Tipo Size MGL C 200 P
Cost. tempo eccitaz. Field time constant (ms) 520	Ventilazione Ventilation IC 06
Massa del motore Mass of the motor (Kg) 700	
Momento d'inerzia rotore Rotor inertia moment (Kgm2) 1.32	

Avv.	Velocità nominale n/min a tensione nominale di armatura Rated speed (rev/min) at rated voltage							Potenza Power kW	Coppia vel. nomin. Torque at rated speed Nm	Rendimento Efficiency %	Circuito di armatura Armature circuit			Max giri Max. speed (°)
	220	400	440	460	470	520	600				Corrente Current Amp	Res. 115°C mOhm	Ind. mH	
45	880	---	---	---	---	---	---	94.2	1022	87.9	487	43.1	0.48	3000
		1685	---	---	---	---	---	180	1020	92.4	487			3000
		---	1865	---	---	---	---	200	1024	93.3	487			3000
		---	---	1955	---	---	---	209	1021	93.3	487			3000
		---	---	---	2000	---	---	214	1022	93.5	487			3000
		---	---	---	---	2225	---	238	1022	94.0	487			3000
		---	---	---	---	---	2580	276	1022	94.5	487			3000
		---	---	---	---	---	---	---	---	---	---			---
46	810	---	---	---	---	---	---	89.1	1050	87.1	465	49.3	0.63	3000
		1555	---	---	---	---	---	171	1050	91.9	465			3000
		---	1720	---	---	---	---	190	1055	92.9	465			3000
		---	---	1800	---	---	---	198	1050	93.0	463			3000
		---	---	---	1845	---	---	202	1046	93.0	462			3000
		---	---	---	---	2050	---	222	1034	93.4	457			3000
		---	---	---	---	---	2385	254	1017	94.5	448			3000
		---	---	---	---	---	---	---	---	---	---			---
47	780	---	---	---	---	---	---	87.0	1065	87.1	454	50.8	0.7	3000
		1500	---	---	---	---	---	167	1063	92.0	454			3000
		---	1660	---	---	---	---	185	1064	92.6	454			3000
		---	---	1740	---	---	---	193	1059	92.8	452			3000
		---	---	---	1780	---	---	197	1057	92.9	451			3000
		---	---	---	---	1975	---	217	1049	93.6	446			3000
		---	---	---	---	---	2295	247	1028	94.2	437			3000
		---	---	---	---	---	---	---	---	---	---			---
48	745	---	---	---	---	---	---	79.7	1022	86.3	420	59	0.68	3000
		1440	---	---	---	---	---	154	1021	91.7	420			3000
		---	1595	---	---	---	---	171	1024	92.5	420			3000
		---	---	1670	---	---	---	178	1018	92.6	418			3000
		---	---	---	1710	---	---	182	1016	92.6	418			3000
		---	---	---	---	1905	---	201	1008	93.4	414			3000
		---	---	---	---	---	2210	229	990	93.8	407			3000
		---	---	---	---	---	---	---	---	---	---			---
49	705	---	---	---	---	---	---	77.7	1053	86.1	410	61.7	0.8	3000
		1360	---	---	---	---	---	150	1053	91.5	410			3000
		---	1505	---	---	---	---	166	1053	92.0	410			3000
		---	---	1580	---	---	---	174	1052	92.5	409			3000
		---	---	---	1615	---	---	178	1053	92.8	408			3000
		---	---	---	---	1795	---	196	1043	93.3	404			3000
		---	---	---	---	---	2090	224	1024	93.8	398			3000
		---	---	---	---	---	---	---	---	---	---			---
50	630	---	---	---	---	---	---	65.6	994.3	84.0	355	84.4	1.22	3000
		1235	---	---	---	---	---	128	989.7	90.1	355			3000
		---	1370	---	---	---	---	142	989.8	90.9	355			3000
		---	---	1435	---	---	---	149	991.5	91.5	354			3000
		---	---	---	1470	---	---	152	987.4	91.6	353			3000
		---	---	---	---	1640	---	168	978.2	92.0	351			3000
		---	---	---	---	---	1905	194	972.5	93.4	346			3000
		---	---	---	---	---	---	---	---	---	---			---
51	565	---	---	---	---	---	---	65.1	1100	83.4	355	89	1.32	2688
		1110	---	---	---	---	---	128	1101	90.1	355			3000
		---	1230	---	---	---	---	142	1102	90.9	355			3000
		---	---	1290	---	---	---	149	1103	91.5	354			3000
		---	---	---	1320	---	---	152	1100	91.4	354			3000
		---	---	---	---	1470	---	168	1091	92.0	351			3000
		---	---	---	---	---	1710	194	1083	93.2	347			3000
		---	---	---	---	---	---	---	---	---	---			---

Nota (\*) - VENTILAZIONE SOLO L.O. / FAN ONLY SIDE COMMUTATOR

Nota (°) - Regolazione di campo / Field weakening



Potenza eccitazione Excitation power (w)	2900	Tipo Size	MGL C 200 P
Cost. tempo eccitaz. Field time constant (ms)	520	Ventilazione Ventilation	IC 06
Massa del motore Mass of the motor (Kg)	700		
Momento d'inerzia rotore Rotor inertia moment (Kgm2)	1.32		

Avv.	Velocità nominale n/min a tensione nominale di armatura Rated speed (rev/min) at rated voltage							Potenza Power kW	Coppia vel. nomin. Torque at rated speed Nm	Rendimento Efficiency %	Circuito di armatura Armature circuit			Max giri Max. speed (°)	
	220	400	440	460	470	520	600				Corrente Current Amp	Res. 115°C mOhm	Ind. mH		
52	505	---	---	---	---	---	---	58.1	1099	82.5	320	104	1.36	2483	
		995	---	---	---	---	---	115	1104	89.8	320			2898	
		1105	---	---	---	---	---	---	127	1098	90.2			320	2948
			1160	---	---	---	---	---	133	1095	90.6			319	2978
		1185	---	---	---	---	---	---	136	1096	90.7			319	2992
			1320	---	---	---	---	---	151	1092	91.6			317	3000
		1540		---	---	---	---	---	174	1079	92.7			313	3000
		53	450	---	---	---	---	---	---	52.7	1118			80.7	297
895	---			---	---	---	---	105	1120	88.4	297	2601			
995	---			---	---	---	---	---	117	1123	89.5	297	2646		
	1045			---	---	---	---	---	123	1124	90.3	296	2671		
1070	---			---	---	---	---	---	126	1125	90.6	296	2683		
	1195			---	---	---	---	---	139	1111	90.6	295	2739		
1395				---	---	---	---	---	161	1102	91.9	292	2816		
54	405			---	---	---	---	---	---	44.2	1042	78.8	255	163	1.75
		815	---	---	---	---	---	89.4	1048	87.6	255	2433			
		905	---	---	---	---	---	---	99.4	1049	88.6	255	2477		
			950	---	---	---	---	---	104	1045	88.7	255	2501		
		975	---	---	---	---	---	---	107	1048	89.6	254	2512		
			1090	---	---	---	---	---	119	1043	90.5	253	2564		
		1270		---	---	---	---	---	138	1038	91.6	251	2635		
		55	370	---	---	---	---	---	---	42.8	1105	78.4	248		
750	---			---	---	---	---	86.8	1105	87.5	248	2099			
835	---			---	---	---	---	---	96.5	1104	88.4	248	2134		
	875			---	---	---	---	---	101	1102	88.5	248	2154		
900	---			---	---	---	---	---	104	1104	89.6	247	2163		
	1005			---	---	---	---	---	115	1093	89.9	246	2206		
1170				---	---	---	---	---	134	1094	91.5	244	2265		
56	330			---	---	---	---	---	---	35.5	1027	75.4	214	231	2.48
		685	---	---	---	---	---	73.4	1023	85.7	214	2268			
		760	---	---	---	---	---	---	81.8	1028	86.9	214	2314		
			800	---	---	---	---	---	85.9	1025	87.3	214	2338		
		820	---	---	---	---	---	---	88.0	1025	87.5	214	2350		
			920	---	---	---	---	---	98.1	1018	88.6	213	2402		
		1075		---	---	---	---	---	114	1013	90.0	211	2473		
		57	305	---	---	---	---	---	---	31.9	998.8	74.0	196		
635	---			---	---	---	---	66.6	1002	84.9	196	2269			
705	---			---	---	---	---	---	74.4	1008	86.3	196	2320		
	745			---	---	---	---	---	78.1	1001	86.6	196	2346		
760	---			---	---	---	---	---	80.0	1005	86.8	196	2358		
	855			---	---	---	---	---	89.3	997.4	88.1	195	2414		
1000				---	---	---	---	---	104	993.1	89.3	194	2490		
58	267			---	---	---	---	---	---	24.1	861.9	71.1	154	382	3.05
		570	---	---	---	---	---	51.3	859.4	83.3	154	2138			
		635	---	---	---	---	---	---	57.3	861.7	84.6	154	2200		
			670	---	---	---	---	---	60.3	859.4	85.1	154	2230		
		685	---	---	---	---	---	---	61.8	861.5	85.4	154	2245		
			770	---	---	---	---	---	69.1	857.0	86.9	153	2311		
		905		---	---	---	---	---	80.7	851.5	88.5	152	2399		

Nota (\*) - VENTILAZIONE SOLO L.O. / FAN ONLY SIDE COMMUTATOR

Nota (°) - Regolazione di campo / Field weakening



Potenza eccitazione Excitation power (w) 2900	Tipo Size MGL C 200 P
Cost. tempo eccitaz. Field time constant (ms) 520	Ventilazione Ventilation IC 06
Massa del motore Mass of the motor (Kg) 700	
Momento d'inerzia rotore Rotor inertia moment (Kgm2) 1.32	

Avv.	Velocità nominale n/min a tensione nominale di armatura Rated speed (rev/min) at rated voltage							Potenza Power kW	Coppia vel. nomin. Torque at rated speed Nm	Rendimento Efficiency %	Circuito di armatura Armature circuit			Max giri Max. speed (°)					
	220	400	440	460	470	520	600				Corrente Current Amp	Res. 115°C mOhm	Ind. mH						
59	221	---	---	---	---	---	---	20.7	894.4	67.7	139	478	3.92	1105					
		485	---	---	---	---	---	45.3	891.9	81.5					139	1854			
		---	540	---	---	---	---	50.7	896.6	82.9					139	1911			
		---	---	570	---	---	---	53.4	894.6	83.5					139	1938			
		---	---	---	585	---	---	54.8	894.5	83.9					139	1951			
		---	---	---	---	660	---	61.4	888.4	85.6					138	2009			
		---	---	---	---	---	775	72.0	887.2	87.0					138	2088			
		---	---	---	---	---	---	---	---	---					---	---	---	---	---
60	425	---	---	---	---	---	---	40.4	907.7	78.9	128	598.0	4.86	1656					
		480	---	---	---	---	---	45.4	903.2	80.6					128	1708			
		---	505	---	---	---	---	47.9	905.8	81.4					128	1733			
		---	---	520	---	---	---	49.2	903.5	81.8					128	1745			
		---	---	---	585	---	---	55.3	902.7	83.7					127	1798			
		---	---	---	---	690	---	65.1	901.0	85.4					127	1869			
		---	---	---	---	---	---	---	---	---					---	---	---	---	---
		---	---	---	---	---	---	---	---	---					---	---	---	---	---
61	385	---	---	---	---	---	---	36.5	905.3	78.0	117	685	5.29	1516					
		435	---	---	---	---	---	41.1	902.2	79.8					117	1565			
		---	460	---	---	---	---	43.4	901.0	80.6					117	1588			
		---	---	470	---	---	---	44.5	904.1	80.9					117	1599			
		---	---	---	530	---	---	50.2	904.5	82.5					117	1649			
		---	---	---	---	630	---	59.1	895.8	84.9					116	1714			
		---	---	---	---	---	---	---	---	---					---	---	---	---	---
		---	---	---	---	---	---	---	---	---					---	---	---	---	---
62	345	---	---	---	---	---	---	31.9	883.0	76.0	105	843	6.71	1367					
		390	---	---	---	---	---	36.0	881.5	77.9					105	1413			
		---	415	---	---	---	---	38.1	876.7	78.9					105	1434			
		---	---	425	---	---	---	39.1	878.5	79.2					105	1444			
		---	---	---	480	---	---	44.2	879.3	81.0					105	1489			
		---	---	---	---	570	---	52.3	876.2	83.8					104	1547			
		---	---	---	---	---	---	---	---	---					---	---	---	---	---
		---	---	---	---	---	---	---	---	---					---	---	---	---	---
63	320	---	---	---	---	---	---	30.1	898.2	74.5	101	940	7.69	1269					
		360	---	---	---	---	---	34.0	901.9	76.5					101	1333			
		---	385	---	---	---	---	36.0	892.9	77.5					101	1350			
		---	---	395	---	---	---	37.0	894.5	77.9					101	1358			
		---	---	---	445	---	---	41.9	899.1	79.8					101	1394			
		---	---	---	---	530	---	49.7	895.5	82.8					100	1440			
		---	---	---	---	---	---	---	---	---					---	---	---	---	---
		---	---	---	---	---	---	---	---	---					---	---	---	---	---
64	290	---	---	---	---	---	---	27.6	908.8	72.6	95	1070	9.05	1189					
		330	---	---	---	---	---	31.4	908.6	75.1					95	1224			
		---	350	---	---	---	---	33.2	905.8	76.1					94.9	1240			
		---	---	360	---	---	---	34.1	904.5	76.5					94.9	1248			
		---	---	---	410	---	---	38.8	903.7	78.8					94.7	1281			
		---	---	---	---	485	---	46.1	907.7	81.3					94.5	1324			
		---	---	---	---	---	---	---	---	---					---	---	---	---	---
		---	---	---	---	---	---	---	---	---					---	---	---	---	---
65	262	---	---	---	---	---	---	24.3	885.7	70.6	86	1280	10.2	1120					
		299	---	---	---	---	---	27.7	884.7	73.2					86	1164			
		---	315	---	---	---	---	29.4	891.3	74.4					85.9	1183			
		---	---	325	---	---	---	30.2	887.4	74.8					85.9	1193			
		---	---	---	370	---	---	34.4	887.8	77.1					85.8	1234			
		---	---	---	---	445	---	41.0	879.8	79.8					85.6	1287			
		---	---	---	---	---	---	---	---	---					---	---	---	---	---
		---	---	---	---	---	---	---	---	---					---	---	---	---	---

Nota (\*) - VENTILAZIONE SOLO L.O. / FAN ONLY SIDE COMMUTATOR

Nota (°) - Regolazione di campo / Field weakening



Potenza eccitazione Excitation power (w) 2900	Tipo Size MGL C 200 P
Cost. tempo eccitaz. Field time constant (ms) 520	Ventilazione Ventilation IC 06
Massa del motore Mass of the motor (Kg) 700	
Momento d'inerzia rotore Rotor inertia moment (Kgm2) 1.32	

Avv.	Velocità nominale n/min a tensione nominale di armatura Rated speed (rev/min) at rated voltage							Potenza Power kW	Coppia vel. nomin. Torque at rated speed Nm	Rendimento Efficiency %	Circuito di armatura Armature circuit			Max giri Max. speed (°)	
	220	400	440	460	470	520	600				Corrente Current Amp	Res. 115°C mOhm	Ind. mH		
66		235	----	----	----	----	----	21.8	885.8	69.0	79	1490	11.8	994	
			269	----	----	----	----	24.9	883.9	71.6					1033
			286	----	----	----	----	26.4	881.5	72.6					1051
			294	----	----	----	----	27.2	883.5	73.3					1059
			335	----	----	----	----	31	883.7	75.7					1095
			405	----	----	----	----	37.2	877.1	78.8					1142
67		202	----	----	----	----	----	18.5	874.6	65.1	71	1860.0	15	936	
			233	----	----	----	----	21.3	873.0	68.2					970
			248	----	----	----	----	22.7	874.1	69.5					986
			256	----	----	----	----	23.4	872.9	70.1					993
			294	----	----	----	----	26.9	873.7	73.0					1024
			355	----	----	----	----	32.4	871.5	76.4					1064
68		206	----	----	----	----	----	19.2	890.0	65.1	67	2170	16.9	859	
			220	----	----	----	----	20.6	894.2	66.8					874
			227	----	----	----	----	21.2	891.8	67.3					880
			262	----	----	----	----	24.5	893.0	70.4					909
			320	----	----	----	----	29.7	886.3	74.1					945

Nota (\*) - VENTILAZIONE SOLO L.O. / FAN ONLY SIDE COMMUTATOR

Nota (°) - Regolazione di campo / Field weakening



Potenza eccitazione Excitation power (w)	3200	Tipo	
Cost. tempo eccitaz. Field time constant (ms)	550	Size	MGL C 200 X
Massa del motore Mass of the motor (Kg)	740	Ventilazione Ventilation	IC 06
Momento d'inerzia rotore Rotor inertia moment (Kgm2)	1.45		

Avv.	Velocità nominale n/min a tensione nominale di armatura Rated speed (rev/min) at rated voltage							Potenza Power kW	Coppia vel. nomin. Torque at rated speed Nm	Rendimento Efficiency %	Circuito di armatura Armature circuit			Max giri Max. speed (°)
	220	400	440	460	470	520	600				Corrente Current Amp	Res. 115°C mOhm	Ind. mH	
45	800	---	---	---	---	---	---	91.8	1096	85.7	487	49.2	0.53	2790
		1550	---	---	---	---	---	177	1091	90.9	487			2790
		---	1715	---	---	---	---	196	1091	91.5	487			2790
		---	---	1800	---	---	---	205	1088	91.5	487			2790
		---	---	---	1840	---	---	210	1090	91.7	487			2790
		---	---	---	---	2045	---	234	1093	92.4	487			2790
		---	---	---	---	---	2380	273	1095	93.4	487			2790
46	740	---	---	---	---	---	---	85.9	1109	84.0	465	54.0	0.69	2790
		1430	---	---	---	---	---	166	1109	89.2	465			2790
		---	1585	---	---	---	---	183	1103	89.4	465			2790
		---	---	1660	---	---	---	191	1099	89.7	463			2790
		---	---	---	1700	---	---	195	1095	89.8	462			2790
		---	---	---	---	1895	---	215	1083	90.5	457			2790
		---	---	---	---	---	2200	244	1059	90.8	448			2790
47	715	---	---	---	---	---	---	85.8	1146	85.9	454	54.1	0.75	2790
		1380	---	---	---	---	---	166	1149	91.4	454			2790
		---	1530	---	---	---	---	184	1148	92.1	454			2790
		---	---	1605	---	---	---	192	1142	92.3	452			2790
		---	---	---	1640	---	---	196	1141	92.5	451			2790
		---	---	---	---	1820	---	215	1128	92.7	446			2790
		---	---	---	---	---	2125	245	1101	93.4	437			2790
48	685	---	---	---	---	---	---	78.8	1099	85.3	420	61.6	0.74	2790
		1330	---	---	---	---	---	153	1099	91.1	420			2790
		---	1470	---	---	---	---	170	1104	92.0	420			2790
		---	---	1545	---	---	---	177	1094	92.1	418			2790
		---	---	---	1580	---	---	181	1094	92.1	418			2790
		---	---	---	---	1760	---	199	1080	92.4	414			2790
		---	---	---	---	---	2045	228	1065	93.4	407			2790
49	645	---	---	---	---	---	---	76.6	1134	84.9	410	65.9	0.87	2790
		1250	---	---	---	---	---	149	1138	90.9	410			2790
		---	1390	---	---	---	---	165	1134	91.5	410			2790
		---	---	1455	---	---	---	173	1135	92.0	409			2790
		---	---	---	1490	---	---	176	1128	91.8	408			2790
		---	---	---	---	1660	---	195	1122	92.8	404			2790
		---	---	---	---	---	1930	223	1103	93.4	398			2790
50	540	---	---	---	---	---	---	64.5	1141	82.6	355	90.5	1.3	2790
		1080	---	---	---	---	---	127	1123	89.4	355			2790
		---	1195	---	---	---	---	141	1127	90.3	355			2790
		---	---	1250	---	---	---	148	1131	90.9	354			2790
		---	---	---	1285	---	---	151	1122	91.0	353			2790
		---	---	---	---	1435	---	167	1111	91.5	351			2790
		---	---	---	---	---	1675	192	1095	92.5	346			2790
51	520	---	---	---	---	---	---	64.5	1185	82.6	355	90.5	1.4	2500
		1025	---	---	---	---	---	127	1183	89.4	355			2790
		---	1135	---	---	---	---	141	1186	90.3	355			2790
		---	---	1190	---	---	---	148	1188	90.9	354			2790
		---	---	---	1220	---	---	151	1182	90.8	354			2790
		---	---	---	---	1360	---	167	1173	91.5	351			2790
		---	---	---	---	---	1585	192	1157	92.2	347			2790

Nota (\*) - VENTILAZIONE SOLO L.O. / FAN ONLY SIDE COMMUTATOR

Nota (°) - Regolazione di campo / Field weakening



Potenza eccitazione Excitation power (w)	3200	Tipo Size	MGL C 200 X
Cost. tempo eccitaz. Field time constant (ms)	550	Ventilazione Ventilation	IC 06
Massa del motore Mass of the motor (Kg)	740		
Momento d'inerzia rotore Rotor inertia moment (Kgm2)	1.45		

Avv.	Velocità nominale n/min a tensione nominale di armatura Rated speed (rev/min) at rated voltage							Potenza Power kW	Coppia vel. nomin. Torque at rated speed Nm	Rendimento Efficiency %	Circuito di armatura Armature circuit			Max giri Max. speed (°)
	220	400	440	460	470	520	600				Corrente Current Amp	Res. 115°C mOhm	Ind. mH	
52	460	---	---	---	---	---	---	56.9	1181	80.8	320	111.9	1.5	2309
		915	---	---	---	---	---	113	1179	88.3	320			2695
		1015	---	---	---	---	---	126	1185	89.5	320			2742
			1065	---	---	---	---	132	1184	90.0	319			2770
		1090	---	---	---	---	---	135	1183	90.0	319			2783
			1220	---	---	---	---	150	1174	91.0	317			2790
		1420	---	---	---	---	---	172	1157	91.6	313			2790
		53	405	---	---	---	---	---	---	51.4	1212			78.7
820	---			---	---	---	---	104	1211	87.5	297	2419		
915	---			---	---	---	---	115	1200	88.0	297	2461		
	960			---	---	---	---	121	1204	88.9	296	2484		
985	---			---	---	---	---	124	1202	89.1	296	2495		
	1100			---	---	---	---	138	1198	90.0	295	2547		
1285	---			---	---	---	---	159	1182	90.8	292	2619		
54	365			---	---	---	---	---	---	43.3	1133	77.2	255	173.9
		745	---	---	---	---	---	88.2	1131	86.5	255	2263		
		830	---	---	---	---	---	98.2	1130	87.5	255	2304		
			875	---	---	---	---	103	1124	87.8	255	2326		
		895	---	---	---	---	---	105	1120	88.0	254	2336		
			1000	---	---	---	---	117	1117	88.9	253	2385		
		1170	---	---	---	---	---	136	1110	90.3	251	2451		
		55	335	---	---	---	---	---	---	41.6	1186	76.2	248	
685	---			---	---	---	---	85.4	1191	86.1	248	1952		
765	---			---	---	---	---	95.2	1188	87.2	248	1985		
	805			---	---	---	---	100	1186	87.7	248	2003		
825	---			---	---	---	---	102	1181	87.9	247	2012		
	920			---	---	---	---	114	1183	89.1	246	2052		
1080	---			---	---	---	---	132	1167	90.2	244	2106		
56	305			---	---	---	---	---	---	35.0	1096	74.3	214	237.6
		630	---	---	---	---	---	72.8	1104	85.0	214	2109		
		705	---	---	---	---	---	81.1	1099	86.1	214	2152		
			740	---	---	---	---	85.3	1101	86.7	214	2174		
		760	---	---	---	---	---	87.4	1098	86.9	214	2186		
			850	---	---	---	---	97.5	1095	88.0	213	2234		
		995	---	---	---	---	---	113	1085	89.3	211	2300		
		57	275	---	---	---	---	---	---	31.1	1080	72.1	196	
580	---			---	---	---	---	65.7	1082	83.8	196	2110		
650	---			---	---	---	---	73.4	1078	85.1	196	2158		
	685			---	---	---	---	77.2	1076	85.6	196	2182		
700	---			---	---	---	---	79.1	1079	85.9	196	2193		
	800			---	---	---	---	88.3	1054	87.1	195	2245		
920	---			---	---	---	---	103	1069	88.5	194	2316		
58	240			---	---	---	---	---	---	23.1	919.1	68.2	154	415.1
		520	---	---	---	---	---	50.2	921.9	81.5	154	1988		
		580	---	---	---	---	---	56.2	925.3	82.9	154	2046		
			610	---	---	---	---	59.2	926.8	83.6	154	2074		
		630	---	---	---	---	---	60.7	920.1	83.9	154	2088		
			705	---	---	---	---	67.8	918.4	85.2	153	2149		
		830	---	---	---	---	---	79.3	912.4	87.0	152	2231		

Nota (\*) - VENTILAZIONE SOLO L.O. / FAN ONLY SIDE COMMUTATOR

Nota (°) - Regolazione di campo / Field weakening





Potenza eccitazione Excitation power (w)	3200	Tipo	
Cost. tempo eccitaz. Field time constant (ms)	550	Size	MGL C 200 X
Massa del motore Mass of the motor (Kg)	740	Ventilazione Ventilation	IC 06
Momento d'inerzia rotore Rotor inertia moment (Kgm2)	1.45		

Avv.	Velocità nominale n/min a tensione nominale di armatura Rated speed (rev/min) at rated voltage							Potenza Power kW	Coppia vel. nomin. Torque at rated speed Nm	Rendimento Efficiency %	Circuito di armatura Armature circuit			Max giri Max. speed (°)
	220	400	440	460	470	520	600				Corrente Current Amp	Res. 115°C mOhm	Ind. mH	
59	195	---	---	---	---	---	---	19.6	959.8	64.1	139	527.4	4.3	1028
		440	---	---	---	---	---	44.0	954.9	79.1	139			1724
		490	---	---	---	---	---	49.5	964.7	80.9	139			1777
		520	---	---	---	---	---	52.2	958.6	81.6	139			1802
		535	---	---	---	---	---	53.5	954.9	81.9	139			1814
		600	---	---	---	---	---	59.9	953.3	83.5	138			1868
		710	---	---	---	---	---	70.7	950.9	85.4	138			1942
		60	390	---	---	---	---	---	39.5	967.2	77.1			128
		440	---	---	---	---	44.5	965.8	79.0	128			1588	
			460	---	---	---	47.0	975.7	79.8	128			1612	
				475	---	---	48.3	971.0	80.3	128			1623	
					535	---	54.2	967.4	82.1	127			1672	
						635	64.1	964.0	84.1	127			1738	
61	350	---	---	---	---	---	---	35.4	965.8	75.6	117	749.7	5.8	1410
		395	---	---	---	---	---	40.0	967.0	77.7	117			1455
		415	---	---	---	---	---	42.2	971.0	78.4	117			1477
		430	---	---	---	---	---	43.4	963.8	78.9	117			1487
		485	---	---	---	---	---	49.1	966.7	80.7	117			1534
		575	---	---	---	---	---	57.8	959.9	83.0	116			1594
		62	315	---	---	---	---	---	30.9	936.7	73.6			105
		355	---	---	---	---	34.9	938.8	75.5	105			1314	
			375	---	---	---	37.0	942.2	76.6	105			1334	
				385	---	---	37.9	940.0	76.8	105			1343	
					436	---	42.9	939.6	78.6	105			1385	
						520	50.8	932.9	81.4	104			1439	
63	290	---	---	---	---	---	---	29.5	971.4	73.0	101	979.5	8.4	1205
		330	---	---	---	---	---	33.5	969.4	75.4	101			1240
		350	---	---	---	---	---	35.5	968.6	76.4	101			1256
		360	---	---	---	---	---	36.4	965.5	76.7	101			1263
		410	---	---	---	---	---	41.4	964.3	78.8	101			1296
		490	---	---	---	---	---	48.9	953.0	81.5	100			1339
		64	265	---	---	---	---	---	27.0	972.9	71.1			95
		300	---	---	---	---	30.7	977.2	73.4	95			1138	
			320	---	---	---	32.5	969.9	74.4	94.9			1153	
				330	---	---	33.4	966.5	74.9	94.9			1161	
					375	---	37.9	965.1	77.0	94.7			1191	
						445	45.2	970.0	79.7	94.5			1231	

Nota (\*) - VENTILAZIONE SOLO L.O. / FAN ONLY SIDE COMMUTATOR

Nota (°) - Regolazione di campo / Field weakening



Potenza eccitazione Excitation power (w)	3600	Tipo	MGL C 200 X2
Cost. tempo eccitaz. Field time constant (ms)	590	Size	MGL C 200 X2
Massa del motore Mass of the motor (Kg)	770	Ventilazione Ventilation	IC 06
Momento d'inerzia rotore Rotor inertia moment (Kgm2)	1.58		

Avv.	Velocità nominale n/min a tensione nominale di armatura Rated speed (rev/min) at rated voltage							Potenza Power kW	Coppia vel. nomin. Torque at rated speed Nm	Rendimento Efficiency %	Circuito di armatura Armature circuit			Max giri Max. speed (°)
	220	400	440	460	470	520	600				Corrente Current Amp	Res. 115°C mOhm	Ind. mH	
45	725	---	---	---	---	---	---	91.3	1203	85.2	487	52.4	0.58	2595
		1405	---	---	---	---	---	177	1203	90.9	487			2595
		---	1555	---	---	---	---	196	1204	91.5	487			2595
		---	---	1630	---	---	---	205	1201	91.5	487			2595
		---	---	---	1665	---	---	210	1204	91.7	487			2595
		---	---	---	---	1855	---	234	1205	92.4	487			2595
		---	---	---	---	---	2155	272	1205	93.1	487			2595
46	665	---	---	---	---	---	---	85.5	1228	83.6	465	57.5	0.75	2595
		1295	---	---	---	---	---	166	1224	89.2	465			2595
		---	1435	---	---	---	---	183	1218	89.4	465			2595
		---	---	1505	---	---	---	191	1212	89.7	463			2595
		---	---	---	1540	---	---	195	1209	89.8	462			2595
		---	---	---	---	1715	---	215	1197	90.5	457			2595
		---	---	---	---	---	1995	245	1173	91.1	448			2595
47	645	---	---	---	---	---	---	85.2	1261	85.3	454	57.8	0.82	2595
		1250	---	---	---	---	---	165	1261	90.9	454			2595
		---	1385	---	---	---	---	183	1262	91.6	454			2595
		---	---	1450	---	---	---	191	1258	91.9	452			2595
		---	---	---	1485	---	---	195	1254	92.0	451			2595
		---	---	---	---	1655	---	215	1241	92.7	446			2595
		---	---	---	---	---	1925	245	1215	93.4	437			2595
48	615	---	---	---	---	---	---	78.2	1214	84.6	420	65.7	0.80	2595
		1200	---	---	---	---	---	152	1210	90.5	420			2595
		---	1330	---	---	---	---	169	1213	91.5	420			2595
		---	---	1395	---	---	---	176	1205	91.5	418			2595
		---	---	---	1430	---	---	180	1202	91.6	418			2595
		---	---	---	---	1595	---	198	1185	92.0	414			2595
		---	---	---	---	---	1855	228	1174	93.4	407			2595
49	580	---	---	---	---	---	---	76.1	1253	84.4	410	70.2	0.95	2595
		1135	---	---	---	---	---	149	1254	90.9	410			2595
		---	1255	---	---	---	---	165	1256	91.5	410			2595
		---	---	1320	---	---	---	172	1244	91.4	409			2595
		---	---	---	1350	---	---	176	1245	91.8	408			2595
		---	---	---	---	1505	---	194	1231	92.3	404			2595
		---	---	---	---	---	1750	223	1217	93.4	398			2595
50	490	---	---	---	---	---	---	63.9	1245	81.8	355	96.5	1.4	2595
		975	---	---	---	---	---	127	1244	89.4	355			2595
		---	1085	---	---	---	---	141	1241	90.3	355			2595
		---	---	1135	---	---	---	147	1237	90.3	354			2595
		---	---	---	1165	---	---	151	1238	91.0	353			2595
		---	---	---	---	1300	---	167	1227	91.5	351			2595
		---	---	---	---	---	1515	191	1204	92.0	346			2595
51	465	---	---	---	---	---	---	63.9	1312	81.8	355	96.5	1.5	2325
		925	---	---	---	---	---	127	1311	89.4	355			2595
		---	1025	---	---	---	---	141	1314	90.3	355			2595
		---	---	1080	---	---	---	147	1300	90.3	354			2595
		---	---	---	1105	---	---	151	1305	90.8	354			2595
		---	---	---	---	1230	---	167	1297	91.5	351			2595
		---	---	---	---	---	1435	191	1271	91.7	347			2595

Nota (\*) - VENTILAZIONE SOLO L.O. / FAN ONLY SIDE COMMUTATOR

Nota (°) - Regolazione di campo / Field weakening



Potenza eccitazione Excitation power (w)	3600	Tipo	
Cost. tempo eccitaz. Field time constant (ms)	590	Size	MGL C 200 X2
Massa del motore Mass of the motor (Kg)	770	Ventilazione Ventilation	IC 06
Momento d'inerzia rotore Rotor inertia moment (Kgm2)	1.58		

Avv.	Velocità nominale n/min a tensione nominale di armatura Rated speed (rev/min) at rated voltage							Potenza Power kW	Coppia vel. nomin. Torque at rated speed Nm	Rendimento Efficiency %	Circuito di armatura Armature circuit			Max giri Max. speed (°)
	220	400	440	460	470	520	600				Corrente Current Amp	Res. 115°C mOhm	Ind. mH	
52	410	---	---	---	---	---	---	56.3	1311	80.0	320	119.4	1.6	2147
		825	---	---	---	---	---	113	1308	88.3	320			2506
		---	920	---	---	---	---	125	1298	88.8	320			2550
		---	---	965	---	---	---	131	1296	89.3	319			2576
		---	---	---	985	---	---	134	1299	89.4	319			2588
		---	---	---	---	1100	---	149	1294	90.4	317			2595
		---	---	---	---	---	1285	172	1278	91.6	313			2595
53	365	---	---	---	---	---	---	50.7	1326	77.6	297	147.0	1.8	1921
		740	---	---	---	---	---	103	1329	86.7	297			2250
		---	825	---	---	---	---	115	1331	88.0	297			2289
		---	---	865	---	---	---	120	1325	88.1	296			2310
		---	---	---	890	---	---	123	1320	88.4	296			2320
		---	---	---	---	995	---	137	1315	89.3	295			2369
		---	---	---	---	---	1160	159	1309	90.8	292			2436
54	325	---	---	---	---	---	---	42.6	1252	75.9	255	185.3	2.1	1741
		675	---	---	---	---	---	87.6	1239	85.9	255			2105
		---	750	---	---	---	---	97.6	1243	87.0	255			2143
		---	---	790	---	---	---	103	1245	87.8	255			2163
		---	---	---	810	---	---	105	1238	88.0	254			2172
		---	---	---	---	905	---	117	1235	88.9	253			2218
		---	---	---	---	---	1060	136	1225	90.3	251			2279
55	300	---	---	---	---	---	---	40.9	1302	75.0	248	200.8	2.6	1552
		620	---	---	---	---	---	84.8	1306	85.5	248			1815
		---	690	---	---	---	---	94.5	1308	86.6	248			1846
		---	---	725	---	---	---	99.4	1309	87.1	248			1863
		---	---	---	745	---	---	101	1295	87.0	247			1871
		---	---	---	---	830	---	113	1300	88.3	246			1908
		---	---	---	---	---	975	131	1283	89.5	244			1959
56	270	---	---	---	---	---	---	34.3	1213	72.9	214	253.3	2.9	1429
		565	---	---	---	---	---	72.2	1220	84.3	214			1961
		---	635	---	---	---	---	80.6	1212	85.6	214			2001
		---	---	665	---	---	---	84.8	1218	86.1	214			2022
		---	---	---	685	---	---	86.9	1211	86.4	214			2033
		---	---	---	---	765	---	96.9	1210	87.5	213			2078
		---	---	---	---	---	900	113	1199	89.3	211			2139
57	245	---	---	---	---	---	---	30.4	1185	70.5	196	303.7	3.7	1313
		520	---	---	---	---	---	65.1	1196	83.0	196			1962
		---	585	---	---	---	---	72.7	1187	84.3	196			2007
		---	---	615	---	---	---	76.6	1189	85.0	196			2029
		---	---	---	630	---	---	78.5	1190	85.2	196			2039
		---	---	---	---	710	---	87.7	1180	86.5	195			2088
		---	---	---	---	---	803	103	1225	88.5	194			2154
58	210	---	---	---	---	---	---	22.5	1023	66.4	154	442.8	3.6	1155
		465	---	---	---	---	---	49.6	1019	80.5	154			1849
		---	520	---	---	---	---	55.6	1021	82.1	154			1903
		---	---	550	---	---	---	58.6	1017	82.7	154			1929
		---	---	---	565	---	---	60.1	1016	83.0	154			1942
		---	---	---	---	635	---	67.3	1012	84.6	153			1999
		---	---	---	---	---	750	78.8	1003	86.4	152			2075

Nota (\*) - VENTILAZIONE SOLO L.O. / FAN ONLY SIDE COMMUTATOR

Nota (°) - Regolazione di campo / Field weakening



Potenza eccitazione Excitation power (w)	3600	Tipo	
Cost. tempo eccitaz. Field time constant (ms)	590	Size	MGL C 200 X2
Massa del motore Mass of the motor (Kg)	770	Ventilazione Ventilation	IC 06
Momento d'inerzia rotore Rotor inertia moment (Kgm2)	1.58		

Avv.	Velocità nominale n/min a tensione nominale di armatura Rated speed (rev/min) at rated voltage							Potenza Power kW	Coppia vel. nomin. Torque at rated speed Nm	Rendimento Efficiency %	Circuito di armatura Armature circuit			Max giri Max. speed (°)
	220	400	440	460	470	520	600				Corrente Current Amp	Res. 115°C mOhm	Ind. mH	
59	170	---	---	---	---	---	---	19.0	1067	62.1	139	562.4	4.7	956
		390	---	---	---	---	---	43.4	1063	78.1	139			
		440	---	---	---	---	---	48.9	1061	80.0	139			
		465	---	---	---	---	---	51.6	1060	80.7	139			
		480	---	---	---	---	---	52.9	1052	81.0	139			
		540	---	---	---	---	---	59.4	1050	82.8	138			
		640	---	---	---	---	---	70.2	1047	84.8	138			
		60	345	---	---	---	---	---	38.9	1077	76.0			
		390	---	---	---	---	43.9	1075	77.9	128			1477	
		415	---	---	---	---	46.4	1068	78.8	128			1499	
		425	---	---	---	---	47.7	1072	79.3	128			1509	
		480	---	---	---	---	53.6	1066	81.2	127			1555	
		570	---	---	---	---	63.5	1064	83.3	127			1616	
61	310	---	---	---	---	---	---	34.8	1072	74.4	117	799.6	6.3	1311
		350	---	---	---	---	---	39.4	1075	76.5	117			
		375	---	---	---	---	---	41.6	1059	77.3	117			
		385	---	---	---	---	---	42.8	1062	77.8	117			
		435	---	---	---	---	---	48.5	1065	79.7	117			
		515	---	---	---	---	---	57.2	1061	82.2	116			
		62	280	---	---	---	---	---	30.5	1040	72.6			
		315	---	---	---	---	34.6	1049	74.9	105			1222	
		335	---	---	---	---	36.5	1040	75.6	105			1241	
		345	---	---	---	---	37.5	1038	76.0	105			1249	
		390	---	---	---	---	42.5	1041	77.8	105			1288	
		465	---	---	---	---	50.2	1031	80.4	104			1338	
63	260	---	---	---	---	---	---	28.9	1061	71.5	101	1044	9.1	1121
		295	---	---	---	---	---	32.9	1065	74.0	101			
		315	---	---	---	---	---	34.9	1058	75.1	101			
		320	---	---	---	---	---	35.8	1068	75.4	101			
		365	---	---	---	---	---	40.8	1067	77.7	101			
		440	---	---	---	---	---	48.3	1048	80.5	100			
		64	235	---	---	---	---	---	26.4	1073	69.5			
		270	---	---	---	---	30.1	1065	72.0	95			1058	
		285	---	---	---	---	31.9	1069	73.1	94.9			1072	
		295	---	---	---	---	32.8	1062	73.5	94.9			1080	
		335	---	---	---	---	37.4	1066	75.9	94.7			1108	
		400	---	---	---	---	44.7	1067	78.8	94.5			1145	

Nota (\*) - VENTILAZIONE SOLO L.O. / FAN ONLY SIDE COMMUTATOR

Nota (°) - Regolazione di campo / Field weakening



**MOTORI C.C. SERIE MGLC - D.C. MOTORS SERIES MGLC**

Forma costr. IM B3/B5 e derivate - Mounting IM B3/B5 and derived

Protezione IP23S - Protection IP23S

Ventilazione IC06 - Cooling IC06

**MGLC 160 - 180 - 200**

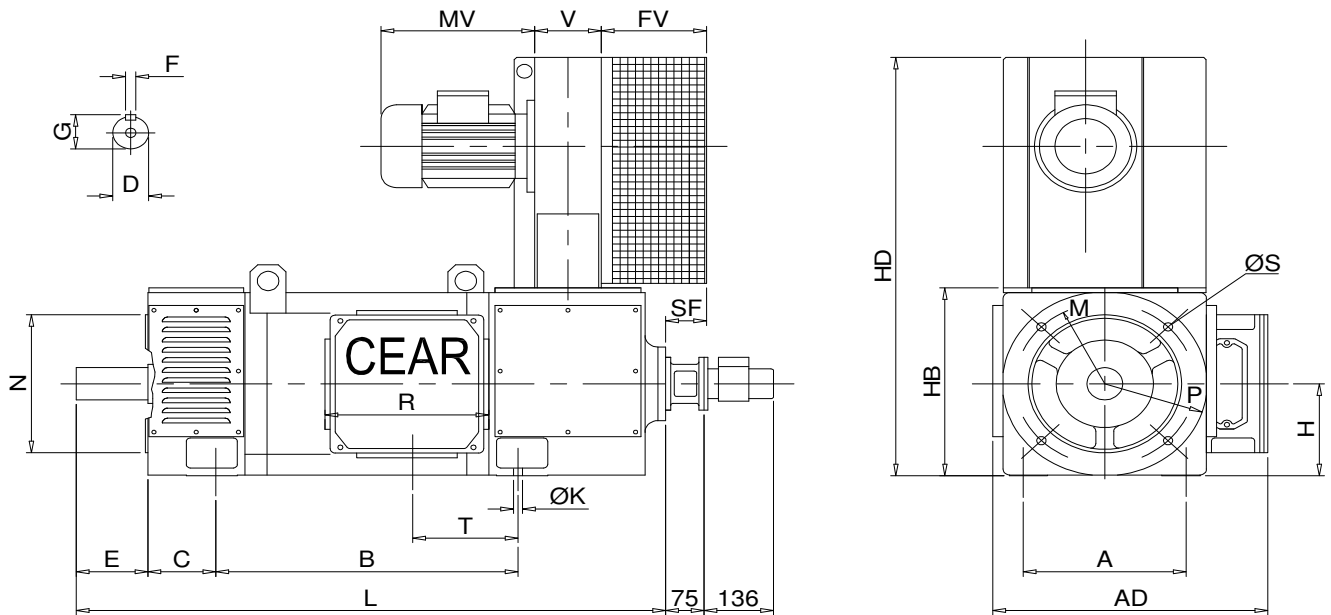

TYPE	SIZE	PIAZZAMENTO					INGOMBRO				ELETTOVENTILATORE				MORSETT.	
		A	B	C	H	K	HD	HB	L	AD	FV	MV	V	SF	R	T
160	K	254	342	108	160	14	637	329	760	433	100	240	115	16	186	145
	S		372						790							
	M		412						830							
	L		462						880							
	P		492						910							
180	K	279	370	121	180	14	727	369	850	483	122	268	115	15	240	171
	S		410						890							
	M		450						930							
	L		500						980							
	P		540						1020							
200	K	318	500	133	200	18	910	409	1061	538	206	300	130	81	320	206
	S		550						1111							
	M		590						1151							
	L		640						1201							
	P		680						1241							
	X		720						1281							

TYPE	ALBERO				FLANGIA			
	E	D	F	G	M	N	S	P
160	140	60	18	64	300	250	18	350
180	140	65	18	69	350	300	18	400
200	140	70	20	74,5	350	300	18	400



Potenza eccitazione Excitation power	(w)	2100	Tipo Size MGL C 250 K Ventilazione Ventilation IC 06
Cost. tempo eccitaz. Field time constant	(ms)	430	
Massa del motore Mass of the motor	(Kg)	900	
Momento d'inerzia rotore Rotor inertia moment	(Kgm2)	2.6	

Avv.	Velocità nominale n/min a tensione nominale di armatura Rated speed (rev/min) at rated voltage							Potenza Power kW	Coppia vel.nomin. Torque at rated speed Nm	Rendimento Efficiency %	Circuito di armatura Armature circuit			Max giri Max. speed (°)			
	220	400	440	460	470	520	600				Corrente Current Amp	Res. 115°C mOhm	Ind. mH				
44	1345	---	---	---	---	---	---	134	951	89.6	680	20.4	0.166	2800	*		
		2535	---	---	---	---	---	253	953	93.0						680	2800
		---	2795	---	---	---	---	280	957	93.6						680	2800
45	1230	---	---	---	---	---	---	123	955	89.5	625	23.3	0.214	2800	*		
		2325	---	---	---	---	---	233	957	93.2						625	2800
		---	2570	---	---	---	---	257	955	93.5						625	2800
		---	---	2690	---	---	---	269	955	93.6						625	2800
		---	---	---	2750	---	---	275	955	93.6						625	2800
46	1095	---	---	---	---	---	---	109	951	89.3	555	27.7	0.301	2800	*		
		2070	---	---	---	---	---	206	950	92.8						555	2800
		---	2290	---	---	---	---	228	951	93.4						555	2800
		---	---	2400	---	---	---	239	951	93.6						555	2800
		---	---	---	2450	---	---	244	951	93.5						555	2800
		---	---	---	---	2725	---	271	950	93.9						555	2800
47	985	---	---	---	---	---	---	96.8	938	88.0	500	36.8	0.287	2800	*		
		1875	---	---	---	---	---	184	937	92.0						500	2800
		---	2075	---	---	---	---	204	939	92.7						500	2800
		---	---	2175	---	---	---	214	940	93.0						500	2800
		---	---	---	2225	---	---	219	940	93.2						500	2800
		---	---	---	---	2470	---	243	940	93.5						500	2800
		---	---	---	---	---	---	---	---	---						---	---
48	900	---	---	---	---	---	---	87	923	87.5	452	43.4	0.386	2800	*		
		1720	---	---	---	---	---	166	922	91.8						452	2800
		---	1905	---	---	---	---	184	922	92.5						452	2800
		---	---	1995	---	---	---	193	924	92.8						452	2800
		---	---	---	2040	---	---	197	922	92.7						452	2800
		---	---	---	---	2270	---	219	921	93.2						452	2800
		---	---	---	---	---	2635	254	921	93.7						452	2800
		---	---	---	---	---	---	---	---	---						---	---
49	715	---	---	---	---	---	---	72.6	970	85.5	386	63.3	0.570	2761	*		
		1380	---	---	---	---	---	140	969	90.7						386	2800
		---	1530	---	---	---	---	156	974	91.9						386	2800
		---	---	1605	---	---	---	163	970	91.8						386	2800
		---	---	---	1640	---	---	167	972	92.1						386	2800
		---	---	---	---	1825	---	186	973	92.7						386	2800
		---	---	---	---	---	2125	216	971	93.3						386	2800
		---	---	---	---	---	---	---	---	---						---	---
		---	---	---	---	---	---	---	---	---						---	---
50	585	---	---	---	---	---	---	58.1	948	83.6	316	91	0.797	2467	*		
		1145	---	---	---	---	---	114	951	90.2						316	2800
		---	1265	---	---	---	---	126	951	90.6						316	2800
		---	---	1330	---	---	---	132	948	90.8						316	2800
		---	---	---	1360	---	---	135	948	90.9						316	2800
		---	---	---	---	1515	---	151	952	91.9						316	2800
		---	---	---	---	---	1765	175	947	92.3						316	2800

Nota (\*) - VENTILAZIONE SOLO L.O. / FAN ONLY SIDE COMMUTATOR

Nota (°) - Regolazione di campo / Field weakening



Potenza eccitazione Excitation power (w) 2100	
Cost. tempo eccitaz. Field time constant (ms) 430	
Massa del motore Mass of the motor (Kg) 900	
Momento d'inerzia rotore Rotor inertia moment (Kgm2) 2.6	
Tipo Size MGL C 250 K	
Ventilazione Ventilation IC 06	

Avv.	Velocità nominale n/min a tensione nominale di armatura Rated speed (rev/min) at rated voltage							Potenza Power kW	Coppia vel.nomin. Torque at rated speed Nm	Rendimento Efficiency %	Circuito di armatura Armature circuit			Max giri Max. speed (°)	
	220	400	440	460	470	520	600				Corrente Current Amp	Res. 115°C mOhm	Ind. mH		
51	495	---	---	---	---	---	---	47.3	913	82.1	262	123	1.250	2439	
		975	---	---	---	---	---	93.3	914	89.0	262				
		1080	---	---	---	---	---	104	920	90.2	262				
		---	---	---	---	---	---	109	917	90.4	262				
		---	---	---	1135	---	---	111	914	90.1	262				
		---	---	---	---	1160	---	124	914	91.0	262				
		---	---	---	---	---	1295	---	144	914	91.6				262
		---	---	---	---	---	---	1505	---	---	---				---
52	445	---	---	---	---	---	---	45.9	985	79.6	262	145	1.04	2231	
		895	---	---	---	---	---	91.9	981	87.7	262				
		---	---	---	---	---	---	102	979	88.5	262				
		---	---	---	---	---	---	107	978	88.8	262				
		---	---	---	1045	---	---	110	982	89.3	262				
		---	---	---	---	1070	---	123	983	90.3	262				
		---	---	---	---	---	1195	---	143	979	91.0				262
		---	---	---	---	---	---	1395	---	---	---				---
53	415	---	---	---	---	---	---	39.9	918	78.9	230	171	1.43	2079	
		835	---	---	---	---	---	80.3	918	87.3	230				
		---	---	---	---	---	---	89.3	917	88.2	230				
		---	---	---	---	---	---	93.8	919	88.7	230				
		---	---	---	975	---	---	96	917	88.8	230				
		---	---	---	---	1000	---	107	916	89.5	230				
		---	---	---	---	---	1115	---	125	915	90.6				230
		---	---	---	---	---	---	1305	---	---	---				---
54	390	---	---	---	---	---	---	36.6	896	78.5	212	190	1.65	1948	
		785	---	---	---	---	---	73.8	898	87.0	212				
		---	---	---	---	---	---	82.1	896	88.0	212				
		---	---	---	---	---	---	86.2	895	88.4	212				
		---	---	---	875	---	---	88.3	897	88.6	212				
		---	---	---	---	920	---	99	898	89.5	212				
		---	---	---	---	---	940	---	115	897	90.4				212
		---	---	---	---	---	1050	---	---	---	---				---
55	350	---	---	---	---	---	---	30	819	76.2	179	252	1.34	1491	
		715	---	---	---	---	---	61.4	820	85.8	179				
		---	---	---	---	---	---	68.4	822	86.8	179				
		---	---	---	---	---	---	71.9	822	87.3	179				
		---	---	---	---	---	---	73.6	822	87.5	179				
		---	---	---	---	---	---	82	823	88.4	179				
		---	---	---	---	---	---	96	821	89.7	179				
		---	---	---	---	---	---	1120	---	---	---				---
56	305	---	---	---	---	---	---	26.2	820	74.4	160	307	2.39	1521	
		630	---	---	---	---	---	54.3	823	84.8	160				
		---	---	---	---	---	---	60.5	825	85.9	160				
		---	---	---	---	---	---	63.6	821	86.4	160				
		---	---	---	---	---	---	65.2	825	86.7	160				
		---	---	---	---	---	---	73	825	87.7	160				
		---	---	---	---	---	---	845	---	---	---				---
		---	---	---	---	---	---	990	---	---	---				---
57	266	---	---	---	---	---	---	22.6	811	71.3	144	392	2.62	1328	
		565	---	---	---	---	---	47.8	808	83.0	144				
		---	---	---	---	---	---	53.4	809	84.3	144				
		---	---	---	---	---	---	56.2	813	84.8	144				
		---	---	---	---	---	---	57.6	809	85.1	144				
		---	---	---	---	---	---	64.7	813	86.4	144				
		---	---	---	---	---	---	760	---	---	---				---
		---	---	---	---	---	---	895	---	---	---				---

Nota (\*) - VENTILAZIONE SOLO L.O. / FAN ONLY SIDE COMMUTATOR

Nota (°) - Regolazione di campo / Field weakening





Potenza eccitazione Excitation power	(w)	2100	Tipo Size Ventilazione Ventilation	MGL C 250 K  IC 06
Cost. tempo eccitaz. Field time constant	(ms)	430		
Massa del motore Mass of the motor	(Kg)	900		
Momento d'inerzia rotore Rotor inertia moment	(Kgm2)	2.6		

Avv.	Velocità nominale n/min a tensione nominale di armatura Rated speed (rev/min) at rated voltage							Potenza Power kW	Coppia vel.nomin. Torque at rated speed Nm	Rendimento Efficiency %	Circuito di armatura Armature circuit			Max giri Max. speed (°)
	220	400	440	460	470	520	600				Corrente Current Amp	Res. 115°C mOhm	Ind. mH	
58	231	---	---	---	---	---	---	19.3	798	67.5	130	500	2.340	1157
		505	---	---	---	---	---	42.1	796	81.0	130			
		565	---	---	---	---	---	47.1	796	82.3	130			
			595	---	---	---	---	49.7	798	83.1	130			
		610	---	---	---	---	---	50.9	797	83.3	130			
			685	---	---	---	---	57.3	799	84.8	130			
		810		---	---	---	---	67.4	795	86.4	130			
59	209	---	---	---	---	---	---	17.4	795	65.9	120	571	3.4	1046
		460	---	---	---	---	---	38.4	797	80.0	120			
		520	---	---	---	---	---	43.1	792	81.6	120			
			545	---	---	---	---	45.4	796	82.2	120			
		560	---	---	---	---	---	46.6	795	82.6	120			
			630	---	---	---	---	52	794	84.0	120			
		745		---	---	---	---	62	792	85.8	120			

Nota (\*) - VENTILAZIONE SOLO L.O. / FAN ONLY SIDE COMMUTATOR

Nota (°) - Regolazione di campo / Field weakening



Potenza eccitazione Excitation power (w) 2300	Tipo Size MGL C 250 S
Cost. tempo eccitaz. Field time constant (ms) 470	Ventilazione Ventilation IC 06
Massa del motore Mass of the motor (Kg) 990	
Momento d'inerzia rotore Rotor inertia moment (Kgm2) 2.9	

Avv.	Velocità nominale n/min a tensione nominale di armatura Rated speed (rev/min) at rated voltage							Potenza Power kW	Coppia vel. nomin. Torque at rated speed Nm	Rendimento Efficiency %	Circuito di armatura Armature circuit			Max giri Max. speed (°)		
	220	400	440	460	470	520	600				Corrente Current Amp	Res. 115°C mOhm	Ind. mH			
42	1420	---	---	---	---	---	---	160	1076	90.9	800	13.7	0.14	2800	*	
		2655	---	---	---	---	---	300	1079	93.8	800				2800	*
43	1205	---	---	---	---	---	---	147	1165	90.3	740	17.8	0.18	2800	*	
		2265	---	---	---	---	---	277	1168	93.6	740				2800	*
		2500	---	---	---	---	---	306	1169	94.0	740				2800	*
			2620	---	---	---	---	320	1166	94.0	740				2800	*
		2675	---	---	---	---	328	1171	94.3	740	2800				*	
44	1085	---	---	---	---	---	---	134	1179	89.6	680	22.4	0.2	2800	*	
		2055	---	---	---	---	---	254	1180	93.4	680				2800	*
		2270	---	---	---	---	---	280	1178	93.6	680				2800	*
			2380	---	---	---	---	293	1176	93.7	680				2800	*
		2435	---	---	---	---	300	1177	93.9	680	2800				*	
		2705	---	---	---	---	333	1176	94.2	680	2800				*	
45	995	---	---	---	---	---	---	123	1181	89.5	625	25.6	0.26	2800	*	
		1890	---	---	---	---	---	233	1177	93.2	625					2800
		2085	---	---	---	---	---	257	1177	93.5	625					2800
			2185	---	---	---	---	269	1176	93.6	625					2800
		2235	---	---	---	---	275	1175	93.6	625	2800					
		2480	---	---	---	---	306	1178	94.2	625	2800					
46	885	---	---	---	---	---	---	109	1176	89.3	555	30.4	0.36	2800	*	
		1680	---	---	---	---	---	206	1171	92.8	555					2800
		1860	---	---	---	---	---	228	1171	93.4	555					2800
			1945	---	---	---	---	239	1173	93.6	555					2800
		1990	---	---	---	---	---	244	1171	93.5	555					2800
			2215	---	---	---	---	271	1168	93.9	555					2800
		2565	---	---	---	---	315	1173	94.6	555	2800					
		47	795	---	---	---	---	---	---	96.3	1157					87.5
1520	---			---	---	---	---	184	1156	92.0	500	2800				
1685	---			---	---	---	---	204	1156	92.7	500	2800				
	1765			---	---	---	---	214	1158	93.0	500	2800				
1805	---			---	---	---	---	219	1159	93.2	500	2800				
	2005			---	---	---	---	243	1157	93.5	500	2800				
2330	---			---	---	---	282	1156	94.0	500	2800					
48	725			---	---	---	---	---	---	87	1139	87.0	452	47.7	0.46	2800
		1395	---	---	---	---	---	166	1136	91.8	452	2800				
		1545	---	---	---	---	---	184	1137	92.5	452	2800				
			1620	---	---	---	---	193	1138	92.8	452	2800				
		1655	---	---	---	---	---	197	1137	92.7	452	2800				
			1840	---	---	---	---	219	1137	93.2	452	2800				
		2140	---	---	---	---	254	1133	93.7	452	2800					

Nota (\*) - VENTILAZIONE SOLO L.O. / FAN ONLY SIDE COMMUTATOR

Nota (°) - Regolazione di campo / Field weakening



Potenza eccitazione Excitation power (w) 2300	Tipo Size MGL C 250 S
Cost. tempo eccitaz. Field time constant (ms) 470	Ventilazione Ventilation IC 06
Massa del motore Mass of the motor (Kg) 990	
Momento d'inerzia rotore Rotor inertia moment (Kgm2) 2.9	

Avv.	Velocità nominale n/min a tensione nominale di armatura Rated speed (rev/min) at rated voltage							Potenza Power kW	Coppia vel. nomin. Torque at rated speed Nm	Rendimento Efficiency %	Circuito di armatura Armature circuit			Max giri Max. speed (°)
	220	400	440	460	470	520	600				Corrente Current Amp	Res. 115°C mOhm	Ind. mH	
49	575	---	---	---	---	---	---	72	1196	84.8	386	69.5	0.68	2415
		1120	---	---	---	---	---	140	1194	90.7	386			2745
		---	1240	---	---	---	---	155	1194	91.3	386			2784
		---	---	1300	---	---	---	163	1197	91.8	386			2800
		---	---	---	1330	---	---	166	1192	91.5	386			2800
		---	---	---	---	1480	---	185	1194	92.2	386			2800
		---	---	---	---	---	1725	216	1196	93.3	386			2800
50	470	---	---	---	---	---	---	57.5	1168	82.7	316	100	0.95	2135
		925	---	---	---	---	---	113	1167	89.4	316			2459
		---	1025	---	---	---	---	126	1174	90.6	316			2498
		---	---	1075	---	---	---	132	1173	90.8	316			2515
		---	---	---	1100	---	---	135	1172	90.9	316			2523
		---	---	---	---	1225	---	150	1169	91.3	316			2558
		---	---	---	---	---	1430	175	1169	92.3	316			2604
51	395	---	---	---	---	---	---	46.6	1127	80.8	262	136	1.50	1973
		785	---	---	---	---	---	92.8	1129	88.5	262			2490
		---	870	---	---	---	---	103	1131	89.3	262			2537
		---	---	915	---	---	---	108	1127	89.6	262			2558
		---	---	---	940	---	---	111	1128	90.1	262			2568
		---	---	---	---	1045	---	124	1133	91.0	262			2611
		---	---	---	---	---	1220	144	1127	91.6	262			2667
52	355	---	---	---	---	---	---	45.1	1213	78.2	262	160	1.24	1780
		720	---	---	---	---	---	91.3	1211	87.1	262			2326
		---	805	---	---	---	---	102	1210	88.5	262			2372
		---	---	845	---	---	---	107	1209	88.8	262			2392
		---	---	---	865	---	---	109	1203	88.5	262			2401
		---	---	---	---	965	---	122	1207	89.5	262			2443
		---	---	---	---	---	1125	143	1214	91.0	262			2497
53	330	---	---	---	---	---	---	39.2	1134	77.5	230	188	1.71	1657
		675	---	---	---	---	---	79.7	1128	86.6	230			2248
		---	750	---	---	---	---	88.7	1129	87.6	230			2294
		---	---	790	---	---	---	93.3	1128	88.2	230			2314
		---	---	---	810	---	---	95.5	1126	88.3	230			2323
		---	---	---	---	905	---	107	1129	89.5	230			2365
		---	---	---	---	---	1055	125	1131	90.6	230			2419
54	310	---	---	---	---	---	---	35.9	1106	77.0	212	209	1.97	1551
		635	---	---	---	---	---	73.3	1102	86.4	212			2370
		---	705	---	---	---	---	81.6	1105	87.5	212			2425
		---	---	740	---	---	---	85.7	1106	87.9	212			2449
		---	---	---	760	---	---	87.8	1103	88.1	212			2460
		---	---	---	---	850	---	98.2	1103	89.1	212			2511
		---	---	---	---	---	990	115	1109	90.4	212			2575
55	277	---	---	---	---	---	---	29.3	1010	74.4	179	277	1.61	1271
		575	---	---	---	---	---	60.9	1011	85.1	179			1531
		---	640	---	---	---	---	67.9	1013	86.2	179			1561
		---	---	675	---	---	---	71.4	1010	86.7	179			1575
		---	---	---	690	---	---	73.1	1012	86.9	179			1581
		---	---	---	---	770	---	81.9	1016	88.0	179			1609
		---	---	---	---	---	905	95.9	1012	89.3	179			1645

Nota (\*) - VENTILAZIONE SOLO L.O. / FAN ONLY SIDE COMMUTATOR

Nota (°) - Regolazione di campo / Field weakening



Potenza eccitazione		
Excitation power	(w)	2300
Cost. tempo eccitaz.		
Field time constant	(ms)	470
Massa del motore		
Mass of the motor	(Kg)	990
Momento d'inerzia rotore		
Rotor inertia moment	(Kgm2)	2.9

Tipo		
Size	MGL C 250	S
Ventilazione		
Ventilation		IC 06

Avv.	Velocità nominale n/min a tensione nominale di armatura Rated speed (rev/min) at rated voltage							Potenza Power kW	Coppia vel. nomin. Torque at rated speed Nm	Rendimento Efficiency %	Circuito di armatura Armature circuit			Max giri Max. speed (°)
	220	400	440	460	470	520	600				Corrente Current Amp	Res. 115°C mOhm	Ind. mH	
56	240	---	---	---	---	---	---	25.50	1015	72.4	160	338	2.89	1202
		505	---	---	---	---	---	53.7	1015	83.9	160			1641
			565	---	---	---	---	60.0	1014	85.2	160			1681
				595	---	---	---	63.1	1013	85.7	160			1699
					610	---	---	64.7	1013	86.0	160			1708
						685	---	72.5	1011	87.1	160			1745
							800	85.0	1015	88.5	160			1794
57	209	---	---	---	---	---	---	21.8	996	68.8	144	432	3.17	1043
		450	---	---	---	---	---	47.2	1002	81.9	144			1514
			505	---	---	---	---	52.8	998	83.3	144			1554
				530	---	---	---	55.6	1002	83.9	144			1572
					545	---	---	57.1	1001	84.4	144			1580
						610	---	64.1	1004	85.6	144			1617
							720	75.4	1000	87.3	144			1664
58	180	---	---	---	---	---	---	18.5	982	64.7	130	550	2.81	902
		405	---	---	---	---	---	41.4	976	79.6	130			1557
			455	---	---	---	---	46.5	976	81.3	130			1606
				480	---	---	---	49.0	975	81.9	130			1627
					490	---	---	50.3	980	82.3	130			1637
						550	---	56.7	985	83.9	130			1682
							650	66.8	981	85.6	130			1740
59	370	---	---	---	---	---	---	37.7	973	78.5	120	630	4.1	1477
		415	---	---	---	---	---	42.4	976	80.3	120			1525
			440	---	---	---	---	44.8	972	81.2	120			1546
				450	---	---	---	46.0	976	81.6	120			1556
					505	---	---	51.8	980	83.0	120			1601
						600	---	61.2	974	85.0	120			1659

Nota (\*) - VENTILAZIONE SOLO L.O. / FAN ONLY SIDE COMMUTATOR

Nota (°) - Regolazione di campo / Field weakening



Potenza eccitazione Excitation power (w)	2700	Tipo Size MGL C 250 M Ventilazione Ventilation IC 06
Cost. tempo eccitaz. Field time constant (ms)	480	
Massa del motore Mass of the motor (Kg)	1080	
Momento d'inerzia rotore Rotor inertia moment (Kgm2)	3.3	

Avv.	Velocità nominale n/min a tensione nominale di armatura Rated speed (rev/min) at rated voltage							Potenza Power kW	Coppia vel. nomin. Torque at rated speed Nm	Rendimento Efficiency %	Circuito di armatura Armature circuit			Max giri Max. speed (°)	
	220	400	440	460	470	520	600				Corrente Current Amp	Res. 115°C mOhm	Ind. mH		
42	1190	---	---	---	---	---	---	160	1284	90.9	800	14.9	0.17	2800	*
		2235	---	---	---	---	---	301	1286	94.1	800			2800	*
		2470	---	---	---	---	---	332	1284	94.3	800			2800	*
			---	---	---	---	---	348	1286	94.6	800			2800	*
			2585	---	---	---	---	355	1284	94.4	800			2800	*
43	1010	---	---	---	---	---	---	147	1390	90.3	740	19.4	0.21	2800	*
		1905	---	---	---	---	---	277	1389	93.6	740			2800	*
		2105	---	---	---	---	---	306	1388	94.0	740			2800	*
			---	---	---	---	---	321	1390	94.3	740			2800	*
			2205	---	---	---	---	328	1389	94.3	740			2800	*
2500	---	---	---	---	364	1390	94.6	740	2800	*					
44	910	---	---	---	---	---	---	134	1406	89.6	680	24.4	0.23	2800	*
		1730	---	---	---	---	---	253	1397	93.0	680			2800	*
		1910	---	---	---	---	---	280	1400	93.6	680			2800	*
			---	---	---	---	---	293	1399	93.7	680			2800	*
			2000	---	---	---	---	300	1401	93.9	680			2800	*
		2045	---	---	---	---	333	1398	94.2	680	2800			*	
		2275	---	---	---	---	387	1400	94.9	680	2800			*	
2640	---	---	---	---	---	---	---	---	---	---	---	---	---	---	
45	835	---	---	---	---	---	---	122	1395	88.7	625	27.9	0.3	2800	*
		1585	---	---	---	---	---	233	1404	93.2	625			2800	*
		1755	---	---	---	---	---	257	1398	93.5	625			2800	*
			---	---	---	---	---	269	1396	93.6	625			2800	*
			1840	---	---	---	---	275	1397	93.6	625			2800	*
		1880	---	---	---	---	306	1398	94.2	625	2800			*	
		2090	---	---	---	---	355	1398	94.7	625	2800			*	
2425	---	---	---	---	---	---	---	---	---	---	---	---	---		
46	740	---	---	---	---	---	---	108	1394	88.5	555	33.2	0.42	2800	*
		1415	---	---	---	---	---	206	1390	92.8	555			2800	*
		1565	---	---	---	---	---	228	1391	93.4	555			2800	*
			---	---	---	---	---	239	1396	93.6	555			2800	*
			1635	---	---	---	---	244	1391	93.5	555			2800	*
		1675	---	---	---	---	271	1391	93.9	555	2800			*	
		1860	---	---	---	---	315	1393	94.6	555	2800			*	
		2160	---	---	---	---	---	---	---	---	---			---	---
47	665	---	---	---	---	---	---	95.7	1374	87.0	500	44	0.4	2800	*
		1280	---	---	---	---	---	184	1373	92.0	500			2800	*
		1415	---	---	---	---	---	204	1377	92.7	500			2800	*
			---	---	---	---	---	213	1370	92.6	500			2800	*
			1485	---	---	---	---	218	1374	92.8	500			2800	*
		1515	---	---	---	---	243	1377	93.5	500	2800			*	
		1685	---	---	---	---	282	1374	94.0	500	2800			*	
1960	---	---	---	---	---	---	---	---	---	---	---	---	---		
48	605	---	---	---	---	---	---	86	1354	86.3	452	52	0.54	2800	*
		1170	---	---	---	---	---	166	1355	91.8	452			2800	*
		1295	---	---	---	---	---	183	1349	92.0	452			2800	*
			---	---	---	---	---	192	1348	92.3	452			2800	*
			1360	---	---	---	---	197	1353	92.7	452			2800	*
		1390	---	---	---	---	219	1354	93.2	452	2800			*	
		1545	---	---	---	---	254	1348	93.7	452	2800			*	
1800	---	---	---	---	---	---	---	---	---	---	---	---	---		

Nota (\*) - VENTILAZIONE SOLO L.O. / FAN ONLY SIDE COMMUTATOR

Nota (°) - Regolazione di campo / Field weakening



Potenza eccitazione Excitation power (w) 2700	Tipo Size MGL C 250 M
Cost. tempo eccitaz. Field time constant (ms) 480	Ventilazione Ventilation IC 06
Massa del motore Mass of the motor (Kg) 1080	
Momento d'inerzia rotore Rotor inertia moment (Kgm2) 3.3	

Avv.	Velocità nominale n/min a tensione nominale di armatura Rated speed (rev/min) at rated voltage							Potenza Power kW	Coppia vel. nomin. Torque at rated speed Nm	Rendimento Efficiency %	Circuito di armatura Armature circuit			Max giri Max. speed (°)		
	220	400	440	460	470	520	600				Corrente Current Amp	Res. 115°C mOhm	Ind. mH			
49	480	---	---	---	---	---	---	71.3	1419	84.0	386	75.7	0.8	2144		
		940	---	---	---	---	---	140	1422	90.7	386			2461		
		1040	---	---	---	---	---	155	1423	91.3	386			2499		
		---	1090	---	---	---	---	162	1419	91.2	386			2515		
		---	---	---	---	1115	---	166	1422	91.5	386			2523		
		---	---	---	---	---	1245	185	1419	92.2	386			2558		
		---	---	---	---	---	---	1445	215	92.8	386			2602		
		50	390	---	---	---	---	---	56.7	1388	81.6			316	109	1.11
51	325	775	---	---	---	---	---	113	1392	89.4	316	148	1.75	2187		
		860	---	---	---	---	---	125	1388	89.9	316			2224		
		---	900	---	---	---	---	131	1390	90.1	316			2240		
		---	---	---	---	925	---	134	1383	90.2	316			2248		
		---	---	---	---	---	1030	150	1391	91.3	316			2282		
		---	---	---	---	---	---	175	1393	92.3	316			2325		
		655	---	---	---	---	---	45.9	1349	79.6	262			174	1.43	1470
		---	---	---	---	---	---	92.2	1344	88.0	262					2065
730	---	---	---	---	---	102	1334	88.5	262	2108						
---	765	---	---	---	---	108	1348	89.6	262	2127						
---	---	---	---	785	---	110	1338	89.3	262	2136						
---	---	---	---	---	875	123	1342	90.3	262	2176						
---	---	---	---	---	---	1025	144	91.6	262	2227						
52	294	---	---	---	---	---	44.2	1436	76.7	262	205	1.99	1366			
600	---	---	---	---	---	---	90.6	1442	86.5	262			1984			
---	670	---	---	---	---	---	101	1440	87.6	262			2027			
---	---	---	---	705	---	---	106	1436	88.0	262			2046			
---	---	---	---	---	720	---	109	1446	88.5	262			2055			
---	---	---	---	---	---	810	121	1427	88.8	262			2095			
---	---	---	---	---	---	---	945	142	90.3	262			2146			
53	273	---	---	---	---	---	38.4	1343	75.9	230			228	2.3	1279	
565	---	---	---	---	---	---	79	1335	85.9	230	2095					
---	---	---	---	---	---	---	88.1	1346	87.1	230	2146					
625	---	---	---	---	---	---	92.6	1340	87.5	230	2169					
---	660	---	---	---	---	---	94.9	1343	87.8	230	2180					
---	---	---	---	675	---	---	106	1341	88.6	230	2228					
---	---	---	---	---	755	---	106	1341	88.6	230	2289					
---	---	---	---	---	---	885	124	1338	89.9	230	2289					
54	256	530	---	---	---	---	---	35.2	1313	75.5	212	302	1.88	1103		
		---	---	---	---	---	---	72.6	1308	85.6	212			1349		
		590	---	---	---	---	---	80.9	1309	86.7	212			1378		
		---	---	---	---	---	---	85.1	1311	87.3	212			1391		
		---	620	---	---	---	---	87.2	1311	87.5	212			1397		
		---	---	---	---	635	---	---	97.6	1313	88.5			212	1423	
		---	---	---	---	---	710	---	114	1312	89.6			212	1457	
		---	---	---	---	---	---	830	114	89.6	212			1457		
55	227	480	---	---	---	---	---	28.6	1203	72.6	179	302	1.88	1103		
		---	---	---	---	---	---	60.2	1198	84.1	179			1349		
		---	---	---	---	---	---	67.3	1201	85.4	179			1378		
		535	---	---	---	---	---	70.8	1207	86.0	179			1391		
		---	---	---	---	---	---	72.5	1204	86.2	179			1397		
		---	---	---	---	560	---	---	81.3	1204	87.3			179	1423	
		---	---	---	---	---	---	---	75.5	1207	88.8			179	1457	
		---	---	---	---	---	---	755	95.4	1207	88.8			179	1457	

Nota (\*) - VENTILAZIONE SOLO L.O. / FAN ONLY SIDE COMMUTATOR

Nota (°) - Regolazione di campo / Field weakening



Potenza eccitazione  
Excitation power (w) 2700  
Cost. tempo eccitaz.  
Field time constant (ms) 480  
Massa del motore  
Mass of the motor (Kg) 1080  
Momento d'inerzia rotore  
Rotor inertia moment (Kgm2) 3.3

Tipo  
Size MGL C 250 M  
Ventilazione  
Ventilation IC 06

Avv.	Velocità nominale n/min a tensione nominale di armatura Rated speed (rev/min) at rated voltage							Potenza Power kW	Coppia vel. nomin. Torque at rated speed Nm	Rendimento Efficiency %	Circuito di armatura Armature circuit			Max giri Max. speed (°)
	220	400	440	460	470	520	600				Corrente Current Amp	Res. 115°C mOhm	Ind. mH	
56	197	---	---	---	---	---	---	24.80	1202	70.5	160	369	3.39	983
		420	---	---	---	---	---	53.1	1207	83.0	160			1449
		470	---	---	---	---	---	59.3	1205	84.2	160			1488
			495	---	---	---	---	62.5	1206	84.9	160			1505
		510	---	---	---	---	---	64.1	1200	85.2	160			1513
			570	---	---	---	---	71.9	1205	86.4	160			1549
		670	---	---	---	---	---	84.5	1204	88.0	160			1595
57	169	---	---	---	---	---	---	21.1	1192	66.6	144	472	3.71	847
		375	---	---	---	---	---	46.5	1184	80.7	144			1331
		420	---	---	---	---	---	52.2	1187	82.4	144			1368
			440	---	---	---	---	55.0	1194	83.0	144			1385
		455	---	---	---	---	---	56.4	1184	83.3	144			1393
			510	---	---	---	---	63.5	1189	84.8	144			1427
		600	---	---	---	---	---	74.8	1191	86.6	144			1472
58	335	---	---	---	---	---	---	40.7	1160	78.3	130	599	3.28	1367
		375	---	---	---	---	---	45.8	1166	80.1	130			1413
		395	---	---	---	---	---	48.3	1168	80.8	130			1433
			405	---	---	---	---	49.6	1170	81.2	130			1443
		460	---	---	---	---	---	56.0	1163	82.8	130			1486
			545	---	---	---	---	66.2	1160	84.9	130			1541
		59	305	---	---	---	---	---	---	37.0	1158			77.1
345	---			---	---	---	---	41.7	1154	79.0	120	1338		
360	---			---	---	---	---	44.1	1170	79.9	120	1358		
	370			---	---	---	---	45.3	1169	80.3	120	1367		
420	---			---	---	---	---	51.1	1162	81.9	120	1410		
	500			---	---	---	---	60.6	1157	84.2	120	1464		

Nota (\*) - VENTILAZIONE SOLO L.O. / FAN ONLY SIDE COMMUTATOR

Nota (°) - Regolazione di campo / Field weakening





Potenza eccitazione Excitation power (w) 3100	Tipo Size MGL C 250 L
Cost. tempo eccitaz. Field time constant (ms) 510	Ventilazione Ventilation IC 06
Massa del motore Mass of the motor (Kg) 1190	
Momento d'inerzia rotore Rotor inertia moment (Kgm2) 3.7	

Avv.	Velocità nominale n/min a tensione nominale di armatura Rated speed (rev/min) at rated voltage							Potenza Power kW	Coppia vel. nomin. Torque at rated speed Nm	Rendimento Efficiency %	Circuito di armatura Armature circuit			Max giri Max. speed (°)	
	220	400	440	460	470	520	600				Corrente Current Amp	Res. 115°C mOhm	Ind. mH		
42	995	---	---	---	---	---	---	160	1536	90.9	800	16.4	0.19	2800	*
		1875	---	---	---	---	---	301	1533	94.1	800			2800	*
		2075	---	---	---	---	---	332	1528	94.3	800			2800	*
			2170	---	---	---	---	348	1531	94.6	800			2800	*
		2220	---	---	---	---	---	356	1531	94.7	800			2800	*
			2465	---	---	---	---	395	1530	95.0	800			2800	*
43	845	---	---	---	---	---	---	146	1650	89.7	740	21.4	25	2800	*
		1600	---	---	---	---	---	277	1653	93.6	740			2800	*
		1765	---	---	---	---	---	306	1656	94.0	740			2800	*
			1850	---	---	---	---	320	1652	94.0	740			2800	*
		1890	---	---	---	---	---	328	1657	94.3	740			2800	*
			2100	---	---	---	---	364	1655	94.6	740			2800	*
2435	---	---	---	---	---	422	1655	95.0	740	2800	*				
44	760	---	---	---	---	---	---	133	1671	88.9	680	26.8	0.27	2800	*
		1450	---	---	---	---	---	253	1666	93.0	680			2800	*
		1605	---	---	---	---	---	280	1666	93.6	680			2800	*
			1680	---	---	---	---	293	1665	93.7	680			2800	*
		1720	---	---	---	---	---	300	1666	93.9	680			2800	*
			1910	---	---	---	---	333	1665	94.2	680			2800	*
2215	---	---	---	---	---	387	1668	94.9	680	2800	*				
45	695	---	---	---	---	---	---	122	1676	88.7	625	30.7	0.35	2738	*
		1330	---	---	---	---	---	232	1666	92.8	625			2800	*
		1470	---	---	---	---	---	257	1670	93.5	625			2800	*
			1540	---	---	---	---	269	1668	93.6	625			2800	*
		1575	---	---	---	---	---	275	1667	93.6	625			2800	*
			1755	---	---	---	---	306	1665	94.2	625			2800	*
2035	---	---	---	---	---	355	1666	94.7	625	2800	*				
46	620	---	---	---	---	---	---	107	1648	87.6	555	36.5	0.5	2800	*
		1185	---	---	---	---	---	206	1660	92.8	555			2800	*
		1310	---	---	---	---	---	227	1655	93.0	555			2800	*
			1375	---	---	---	---	238	1653	93.2	555			2800	*
		1405	---	---	---	---	---	244	1658	93.5	555			2800	*
			1560	---	---	---	---	271	1659	93.9	555			2800	*
1815	---	---	---	---	---	315	1657	94.6	555	2800	*				
47	555	---	---	---	---	---	---	94.9	1633	86.3	500	48.3	0.47	2663	*
		1070	---	---	---	---	---	183	1633	91.5	500			2800	*
		1185	---	---	---	---	---	203	1636	92.3	500			2800	*
			1240	---	---	---	---	213	1640	92.6	500			2800	*
		1270	---	---	---	---	---	218	1639	92.8	500			2800	*
			1415	---	---	---	---	242	1633	93.1	500			2800	*
1645	---	---	---	---	---	282	1637	94.0	500	2800	*				
48	505	---	---	---	---	---	---	85	1607	85.5	452	57.2	0.63	2525	*
		980	---	---	---	---	---	165	1608	91.3	452			2800	*
		1085	---	---	---	---	---	183	1611	92.0	452			2800	*
			1140	---	---	---	---	192	1608	92.3	452			2800	*
		1165	---	---	---	---	---	196	1607	92.3	452			2800	*
			1295	---	---	---	---	218	1608	92.8	452			2800	*
1510	---	---	---	---	---	254	1606	93.7	452	2800	*				

Nota (\*) - VENTILAZIONE SOLO L.O. / FAN ONLY SIDE COMMUTATOR

Nota (°) - Regolazione di campo / Field weakening



Potenza eccitazione Excitation power (w)	3100	Tipo	MGL C 250 L
Cost. tempo eccitaz. Field time constant (ms)	510	Size	MGL C 250 L
Massa del motore Mass of the motor (Kg)	1190	Ventilazione Ventilation	IC 06
Momento d'inerzia rotore Rotor inertia moment (Kgm2)	3.7		

Avv.	Velocità nominale n/min a tensione nominale di armatura Rated speed (rev/min) at rated voltage							Potenza Power kW	Coppia vel. nomin. Torque at rated speed Nm	Rendimento Efficiency %	Circuito di armatura Armature circuit			Max giri Max. speed (°)
	220	400	440	460	470	520	600				Corrente Current Amp	Res. 115°C mOhm	Ind. mH	
49	395	---	---	---	---	---	---	70.3	1700	82.8	386	83.2	0.93	1887
		785	---	---	---	---	---	139	1691	90.0	386			2188
		---	870	---	---	---	---	154	1690	90.7	386			2225
		---	---	910	---	---	---	162	1700	91.2	386			2240
		---	---	---	935	---	---	165	1685	90.9	386			2248
		---	---	---	---	1040	---	184	1690	91.7	386			2281
		---	---	---	---	---	1215	215	1690	92.8	386			2324
50	320	---	---	---	---	---	---	55.8	1665	80.3	316	120	1.3	1610
		645	---	---	---	---	---	112	1658	88.6	316			1930
		---	715	---	---	---	---	124	1656	89.2	316			1965
		---	---	755	---	---	---	130	1644	89.4	316			1980
		---	---	---	770	---	---	134	1662	90.2	316			1987
		---	---	---	---	860	---	149	1655	90.7	316			2019
		---	---	---	---	---	1005	174	1653	91.8	316			2059
51	269	---	---	---	---	---	---	45	1598	78.1	262	163	2.05	1346
		545	---	---	---	---	---	91.4	1602	87.2	262			1947
		---	610	---	---	---	---	102	1597	88.5	262			1989
		---	---	640	---	---	---	107	1597	88.8	262			2008
		---	---	---	655	---	---	109	1589	88.5	262			2016
		---	---	---	---	730	---	122	1596	89.5	262			2056
		---	---	---	---	---	855	143	1597	91.0	262			2106
52	241	---	---	---	---	---	---	43.1	1708	74.8	262	191	1.67	1206
		500	---	---	---	---	---	89.6	1711	85.5	262			1817
		---	560	---	---	---	---	99.9	1704	86.7	262			1858
		---	---	585	---	---	---	105	1714	87.1	262			1877
		---	---	---	600	---	---	108	1719	87.7	262			1885
		---	---	---	---	675	---	120	1698	88.1	262			1923
		---	---	---	---	---	790	141	1704	89.7	262			1971
53	224	---	---	---	---	---	---	37.4	1594	73.9	230	226	2.32	1118
		465	---	---	---	---	---	78.1	1604	84.9	230			1738
		---	520	---	---	---	---	87.2	1601	86.2	230			1778
		---	---	550	---	---	---	91.7	1592	86.7	230			1796
		---	---	---	560	---	---	94	1603	87.0	230			1804
		---	---	---	---	630	---	105	1592	87.8	230			1842
		---	---	---	---	---	740	123	1587	89.1	230			1889
54	209	---	---	---	---	---	---	34.2	1563	73.3	212	250	2.68	1046
		440	---	---	---	---	---	71.8	1558	84.7	212			1836
		---	490	---	---	---	---	80.1	1561	85.9	212			1885
		---	---	515	---	---	---	84.3	1563	86.4	212			1906
		---	---	---	530	---	---	86.4	1557	86.7	212			1916
		---	---	---	---	590	---	96.8	1567	87.8	212			1961
		---	---	---	---	---	695	114	1566	89.6	212			2019
55	185	---	---	---	---	---	---	27.8	1435	70.6	179	332	2.21	925
		395	---	---	---	---	---	59.4	1436	83.0	179			1179
		---	445	---	---	---	---	66.5	1427	84.4	179			1206
		---	---	465	---	---	---	70	1438	85.0	179			1218
		---	---	---	480	---	---	71.7	1426	85.2	179			1224
		---	---	---	---	535	---	80.5	1437	86.5	179			1249
		---	---	---	---	---	630	94.6	1434	88.1	179			1281

Nota (\*) - VENTILAZIONE SOLO L.O. / FAN ONLY SIDE COMMUTATOR

Nota (°) - Regolazione di campo / Field weakening



Potenza eccitazione Excitation power (w)	3100	Tipo Size Ventilazione Ventilation	MGL C 250 L IC 06
Cost. tempo eccitaz. Field time constant (ms)	510		
Massa del motore Mass of the motor (Kg)	1190		
Momento d'inerzia rotore Rotor inertia moment (Kgm2)	3.7		

Avv.	Velocità nominale n/min a tensione nominale di armatura Rated speed (rev/min) at rated voltage							Potenza Power kW	Coppia vel. nomin. Torque at rated speed Nm	Rendimento Efficiency %	Circuito di armatura Armature circuit			Max giri Max. speed (°)	
	220	400	440	460	470	520	600				Corrente Current Amp	Res. 115°C mOhm	Ind. mH		
56	159	---	---	---	---	---	---	23.90	1435	67.9	160	407	3.99	796	
		350	---	---	---	---	---	52.2	1424	81.6					1269
		390	---	---	---	---	---	58.5	1432	83.1					1306
			410	---	---	---	---	61.7	1437	83.8					1322
		420	---	---	---	---	---	63.3	1439	84.2					1330
			475	---	---	---	---	71.1	1429	85.5					1364
		555		---	---	---	---	83.7	1440	87.2					1407
57	310	---	---	---	---	---	45.6	1405	79.2	144	520	4.36	1159		
		345	---	---	---	---	51.3	1420	81.0					1195	
		365	---	---	---	---	---	54.1	1415					81.7	1210
			375	---	---	---	---	55.5	1413					82.0	1218
		425	---	---	---	---	---	62.6	1407					83.6	1250
			500	---	---	---	---	73.9	1411					85.5	1292
		58		274	---	---	---	---	---					39.8	1387
310	---		---		---	---	44.9	1383	78.5	1233					
325	---		---		---	---	---	47.5	1396	79.4	1252				
	335		---		---	---	---	48.7	1388	79.7	1261				
380	---		---		---	---	---	55.1	1385	81.5	1301				
	450		---		---	---	---	65.4	1388	83.8	1353				
59			249		---	---	---	---	---	36.1	1385	75.2	120	758	5.63
	282	---		---	---	---	40.8	1382	77.3	1163					
	298	---		---	---	---	---	43.2	1384	78.3	1182				
		305		---	---	---	---	44.4	1390	78.7	1191				
	345	---		---	---	---	---	50.3	1392	80.6	1231				
		410		---	---	---	---	59.7	1391	82.9	1283				

Nota (\*) - VENTILAZIONE SOLO L.O. / FAN ONLY SIDE COMMUTATOR

Nota (°) - Regolazione di campo / Field weakening



Potenza eccitazione Excitation power (w)	3500	Tipo Size	MGL C 250 P
Cost. tempo eccitaz. Field time constant (ms)	540	Ventilazione Ventilation	IC 06
Massa del motore Mass of the motor (Kg)	1300		
Momento d'inerzia rotore Rotor inertia moment (Kgm2)	4.1		

Avv.	Velocità nominale n/min a tensione nominale di armatura Rated speed (rev/min) at rated voltage							Potenza Power kW	Coppia vel. nomin. Torque at rated speed Nm	Rendimento Efficiency %	Circuito di armatura Armature circuit			Max giri Max. speed (°)	
	220	400	440	460	470	520	600				Corrente Current Amp	Res. 115°C mOhm	Ind. mH		
42	835	---	---	---	---	---	---	159	1818	90.3	800	18.1	0.23	2200	*
		1580	---	---	---	---	---	300	1813	93.8	800			2200	*
		---	1745	---	---	---	---	332	1817	94.3	800			2200	*
		---	---	1825	---	---	---	348	1821	94.6	800			2200	*
		---	---	---	1870	---	---	355	1813	94.4	800			2200	*
		---	---	---	---	---	2075	395	1818	95.0	800			2200	*
		---	---	---	---	---	---	---	---	---	---			---	---
43	705	---	---	---	---	---	---	145	1964	89.1	740	23.6	0.29	2200	*
		1345	---	---	---	---	---	276	1960	93.2	740			2200	*
		---	1485	---	---	---	---	305	1961	93.7	740			2200	*
		---	---	1555	---	---	---	320	1965	94.0	740			2200	*
		---	---	---	1590	---	---	327	1964	94.0	740			2200	*
		---	---	---	---	---	1770	364	1964	94.6	740			2200	*
		---	---	---	---	---	---	2050	422	1966	95.0			740	2200
44	635	---	---	---	---	---	---	132	1985	88.2	680	29.6	0.31	2200	
		1220	---	---	---	---	---	252	1973	92.6	680			2200	
		---	1345	---	---	---	---	279	1981	93.2	680			2200	
		---	---	1410	---	---	---	292	1978	93.4	680			2200	
		---	---	---	1445	---	---	299	1976	93.6	680			2200	
		---	---	---	---	---	1605	333	1981	94.2	680			2200	
		---	---	---	---	---	---	1865	386	1976	94.6			680	2200
45	585	---	---	---	---	---	---	121	1975	88.0	625	33.9	0.41	2200	
		1115	---	---	---	---	---	231	1978	92.4	625			2200	
		---	1235	---	---	---	---	256	1980	93.1	625			2200	
		---	---	1295	---	---	---	268	1976	93.2	625			2200	
		---	---	---	1325	---	---	274	1975	93.3	625			2200	
		---	---	---	---	---	1475	305	1975	93.8	625			2200	
		---	---	---	---	---	---	1710	354	1977	94.4			625	2200
46	515	---	---	---	---	---	---	106	1966	86.8	555	40.4	0.58	2200	
		995	---	---	---	---	---	205	1967	92.3	555			2200	
		---	1100	---	---	---	---	227	1971	93.0	555			2200	
		---	---	1155	---	---	---	238	1968	93.2	555			2200	
		---	---	---	1180	---	---	243	1967	93.2	555			2200	
		---	---	---	---	---	1315	270	1961	93.6	555			2200	
		---	---	---	---	---	---	1525	314	1966	94.3			555	2200
47	460	---	---	---	---	---	---	93.8	1947	85.3	500	53.4	0.54	2200	
		900	---	---	---	---	---	182	1931	91.0	500			2200	
		---	995	---	---	---	---	202	1939	91.8	500			2200	
		---	---	1045	---	---	---	212	1937	92.2	500			2200	
		---	---	---	1065	---	---	217	1946	92.3	500			2200	
		---	---	---	---	---	1190	242	1942	93.1	500			2200	
		---	---	---	---	---	---	1380	281	1945	93.7			500	2200
48	420	---	---	---	---	---	---	84	1908	84.4	452	63.3	0.74	2102	
		820	---	---	---	---	---	164	1910	90.7	452			2200	
		---	910	---	---	---	---	182	1910	91.5	452			2200	
		---	---	955	---	---	---	191	1910	91.9	452			2200	
		---	---	---	980	---	---	195	1900	91.8	452			2200	
		---	---	---	---	---	1090	218	1910	92.8	452			2200	
		---	---	---	---	---	---	1265	253	1910	93.3			452	2200

Nota (\*) - VENTILAZIONE SOLO L.O. / FAN ONLY SIDE COMMUTATOR

Nota (°) - Regolazione di campo / Field weakening



Potenza eccitazione Excitation power (w)	3500	Tipo	MGL C 250 P
Cost. tempo eccitaz. Field time constant (ms)	540	Size	MGL C 250 P
Massa del motore Mass of the motor (Kg)	1300	Ventilazione Ventilation	IC 06
Momento d'inerzia rotore Rotor inertia moment (Kgm2)	4.1		

Avv.	Velocità nominale n/min a tensione nominale di armatura Rated speed (rev/min) at rated voltage							Potenza Power kW	Coppia vel. nomin. Torque at rated speed Nm	Rendimento Efficiency %	Circuito di armatura Armature circuit			Max giri Max. speed (°)
	220	400	440	460	470	520	600				Corrente Current Amp	Res. 115°C mOhm	Ind. mH	
49	330	---	---	---	---	---	---	69.2	2003	81.5	386	91.9	1.09	1647
		655	---	---	---	---	---	138	2012	89.4	386			1937
		---	730	---	---	---	---	153	2001	90.1	386			1971
		---	---	765	---	---	---	160	1997	90.1	386			1986
		---	---	---	780	---	---	164	2008	90.4	386			1993
		---	---	---	---	875	---	183	1997	91.2	386			2025
		---	---	---	---	---	1020	214	2004	92.4	386			2065
50	266	---	---	---	---	---	---	54.6	1960	78.5	316	132	1.52	1330
		540	---	---	---	---	---	111	1963	87.8	316			1696
		---	600	---	---	---	---	123	1958	88.5	316			1728
		---	---	630	---	---	---	129	1955	88.7	316			1743
		---	---	---	645	---	---	132	1954	88.9	316			1749
		---	---	---	---	720	---	148	1963	90.1	316			1779
		---	---	---	---	---	840	173	1967	91.2	316			1817
51	221	---	---	---	---	---	---	43.9	1897	76.2	262	181	2.39	1107
		455	---	---	---	---	---	90.3	1895	86.2	262			1707
		---	510	---	---	---	---	101	1891	87.6	262			1747
		---	---	535	---	---	---	106	1892	88.0	262			1764
		---	---	---	545	---	---	108	1892	87.7	262			1772
		---	---	---	---	610	---	121	1894	88.8	262			1809
		---	---	---	---	---	715	142	1897	90.3	262			1856
52	197	---	---	---	---	---	---	41.9	2031	72.7	262	211	1.94	987
		415	---	---	---	---	---	88.4	2034	84.4	262			1593
		---	465	---	---	---	---	98.7	2027	85.6	262			1632
		---	---	490	---	---	---	104	2027	86.3	262			1648
		---	---	---	500	---	---	106	2025	86.1	262			1656
		---	---	---	---	565	---	119	2011	87.3	262			1692
		---	---	---	---	---	660	140	2026	89.1	262			1737
53	183	---	---	---	---	---	---	36.2	1889	71.5	230	250	2.72	913
		390	---	---	---	---	---	77	1885	83.7	230			1516
		---	435	---	---	---	---	86.1	1890	85.1	230			1554
		---	---	455	---	---	---	90.6	1902	85.6	230			1570
		---	---	---	470	---	---	92.9	1888	85.9	230			1578
		---	---	---	---	525	---	104	1892	87.0	230			1613
		---	---	---	---	---	615	122	1894	88.4	230			1657
54	171	---	---	---	---	---	---	33.1	1848	71.0	212	277	3.13	854
		365	---	---	---	---	---	70.7	1850	83.4	212			1603
		---	410	---	---	---	---	79.1	1842	84.8	212			1648
		---	---	430	---	---	---	83.3	1850	85.4	212			1668
		---	---	---	440	---	---	85.4	1853	85.7	212			1678
		---	---	---	---	495	---	95.8	1848	86.9	212			1720
		---	---	---	---	---	580	112	1844	88.1	212			1774
55	150	---	---	---	---	---	---	26.7	1700	37.3	179	367	2.58	750
		330	---	---	---	---	---	58.4	1690	81.6	179			1027
		---	370	---	---	---	---	65.5	1691	83.2	179			1052
		---	---	390	---	---	---	69	1690	83.8	179			1064
		---	---	---	400	---	---	70.8	1690	84.2	179			1069
		---	---	---	---	445	---	79.6	1708	85.5	179			1092
		---	---	---	---	---	525	93.7	1704	87.2	179			1121

Nota (\*) - VENTILAZIONE SOLO L.O. / FAN ONLY SIDE COMMUTATOR

Nota (°) - Regolazione di campo / Field weakening



Potenza eccitazione Excitation power (w)	3500	Tipo Size MGL C 250 P Ventilazione Ventilation IC 06
Cost. tempo eccitaz. Field time constant (ms)	540	
Massa del motore Mass of the motor (Kg)	1300	
Momento d'inerzia rotore Rotor inertia moment (Kgm2)	4.1	

Avv.	Velocità nominale n/min a tensione nominale di armatura Rated speed (rev/min) at rated voltage							Potenza Power kW	Coppia vel. nomin. Torque at rated speed Nm	Rendimento Efficiency %	Circuito di armatura Armature circuit			Max giri Max. speed (°)
	220	400	440	460	470	520	600				Corrente Current Amp	Res. 115°C mOhm	Ind. mH	
56	128	---	---	---	---	---	---	22.90	1708	65.1	160	451	4.68	641
		288	---	---	---	---	---	51.2	1698	80.0	160			
		325	---	---	---	---	---	57.5	1690	81.7	160			
		340	---	---	---	---	---	60.7	1705	82.5	160			
		350	---	---	---	---	---	62.3	1700	82.8	160			
		395	---	---	---	---	---	70.1	1695	84.3	160			
		465	---	---	---	---	---	82.8	1700	86.3	160			
57	254	---	---	---	---	---	---	44.6	1677	77.4	144	576	5.12	1006
		286	---	---	---	---	---	50.2	1676	79.2	144			
		300	---	---	---	---	---	53.1	1690	80.2	144			
		310	---	---	---	---	---	54.5	1679	80.5	144			
		350	---	---	---	---	---	61.6	1681	82.3	144			
		415	---	---	---	---	---	72.9	1678	84.4	144			
58	225	---	---	---	---	---	---	38.7	1643	74.4	130	729	4.49	1029
		254	---	---	---	---	---	43.8	1647	76.6	130			
		269	---	---	---	---	---	46.4	1647	77.6	130			
		277	---	---	---	---	---	47.7	1644	78.1	130			
		315	---	---	---	---	---	54.1	1640	80.0	130			
		375	---	---	---	---	---	64.3	1637	82.4	130			
59	204	---	---	---	---	---	---	35.0	1638	72.9	120	840	6.6	966
		231	---	---	---	---	---	39.7	1641	75.2	120			
		245	---	---	---	---	---	42.1	1641	76.3	120			
		252	---	---	---	---	---	43.3	1641	76.8	120			
		286	---	---	---	---	---	49.2	1643	78.8	120			
		340	---	---	---	---	---	58.7	1649	81.5	120			

Nota (\*) - VENTILAZIONE SOLO L.O. / FAN ONLY SIDE COMMUTATOR

Nota (°) - Regolazione di campo / Field weakening



Potenza eccitazione Excitation power (w)	3800	Tipo	MGL C 250 X
Cost. tempo eccitaz. Field time constant (ms)	560	Size	MGL C 250 X
Massa del motore Mass of the motor (Kg)	1350	Ventilazione Ventilation	IC 06
Momento d'inerzia rotore Rotor inertia moment (Kgm2)	4.4		

Avv.	Velocità nominale n/min a tensione nominale di armatura Rated speed (rev/min) at rated voltage							Potenza Power kW	Coppia vel. nomin. Torque at rated speed Nm	Rendimento Efficiency %	Circuito di armatura Armature circuit			Max giri Max. speed (°)	
	220	400	440	460	470	520	600				Corrente Current Amp	Res. 115°C mOhm	Ind. mH		
42	765	---	---	---	---	---	---	159	1985	90.3	800	19.1	0.25	2000	*
		1450	---	---	---	---	---	300	1976	93.8	800			2000	*
		1600	---	---	---	---	---	332	1982	94.3	800			2000	*
			1675	---	---	---	---	347	1978	94.3	800			2000	*
		1715	---	---	---	---	355	1977	94.4	800	2000			*	
		1900	---	---	---	---	394	1980	94.7	800	2000			*	
		---	---	---	---	---	---	---	---	---	---			---	---
43	645	---	---	---	---	---	---	145	2147	89.1	740	24.9	0.32	2000	
		1230	---	---	---	---	---	276	2143	93.2	740			2000	
		1360	---	---	---	---	---	305	2142	93.7	740			2000	*
			1425	---	---	---	---	320	2144	94.0	740			2000	*
		1460	---	---	---	---	327	2139	94.0	740	2000			*	
		1620	---	---	---	---	363	2140	94.3	740	2000			*	
		1880	---	---	---	---	422	2144	95.0	740	2000			*	
44	580	---	---	---	---	---	---	131	2157	87.6	680	31.2	0.34	2000	
		1115	---	---	---	---	---	252	2158	92.6	680			2000	
		1235	---	---	---	---	---	279	2157	93.2	680			2000	
			1295	---	---	---	---	292	2153	93.4	680			2000	
		1325	---	---	---	---	299	2155	93.6	680	2000				
		1470	---	---	---	---	332	2157	93.9	680	2000				
		1710	---	---	---	---	386	2156	94.6	680	2000				
45	530	---	---	---	---	---	---	120	2162	87.3	625	35.7	0.44	2000	
		1025	---	---	---	---	---	231	2152	92.4	625			2000	
		1130	---	---	---	---	---	255	2155	92.7	625			2000	
			1185	---	---	---	---	268	2160	93.2	625			2000	
		1215	---	---	---	---	274	2154	93.3	625	2000				
		1350	---	---	---	---	305	2157	93.8	625	2000				
		1570	---	---	---	---	354	2153	94.4	625	2000				
46	470	---	---	---	---	---	---	106	2154	86.8	555	42.6	0.63	2000	
		910	---	---	---	---	---	204	2141	91.9	555			2000	
		1010	---	---	---	---	---	226	2137	92.5	555			2000	
			1055	---	---	---	---	237	2145	92.8	555			2000	
		1080	---	---	---	---	243	2149	93.2	555	2000				
		1205	---	---	---	---	270	2140	93.6	555	2000				
		1400	---	---	---	---	314	2142	94.3	555	2000				
47	420	---	---	---	---	---	---	93.2	2119	84.7	500	56.2	0.59	2000	
		820	---	---	---	---	---	182	2120	91.0	500			2000	
		910	---	---	---	---	---	202	2120	91.8	500			2000	
			955	---	---	---	---	212	2120	92.2	500			2000	
		975	---	---	---	---	216	2116	91.9	500	2000				
		1090	---	---	---	---	241	2111	92.7	500	2000				
		1265	---	---	---	---	280	2114	93.3	500	2000				
48	385	---	---	---	---	---	---	83	2066	83.8	452	66.8	0.8	1914	
		750	---	---	---	---	---	164	2088	90.7	452			2000	
		835	---	---	---	---	---	181	2070	91.0	452			2000	
			875	---	---	---	---	190	2074	91.4	452			2000	
		895	---	---	---	---	195	2081	91.8	452	2000				
		995	---	---	---	---	217	2083	92.3	452	2000				
		1160	---	---	---	---	253	2083	93.3	452	2000				

Nota (\*) - VENTILAZIONE SOLO L.O. / FAN ONLY SIDE COMMUTATOR

Nota (°) - Regolazione di campo / Field weakening





Potenza eccitazione Excitation power (w)	3800	Tipo	MGL C 250 X
Cost. tempo eccitaz. Field time constant (ms)	560	Size	MGL C 250 X
Massa del motore Mass of the motor (Kg)	1350	Ventilazione Ventilation	IC 06
Momento d'inerzia rotore Rotor inertia moment (Kgm2)	4.4		

Avv.	Velocità nominale n/min a tensione nominale di armatura Rated speed (rev/min) at rated voltage							Potenza Power kW	Coppia vel. nomin. Torque at rated speed Nm	Rendimento Efficiency %	Circuito di armatura Armature circuit			Max giri Max. speed (°)
	220	400	440	460	470	520	600				Corrente Current Amp	Res. 115°C mOhm	Ind. mH	
49	299	---	---	---	---	---	---	68.5	2188	80.7	386	96.8	1.18	1496
		600	---	---	---	---	---	137	2180	88.7	386			1817
		665	---	---	---	---	---	152	2183	89.5	386			1851
		700	---	---	---	---	---	160	2183	90.1	386			1865
		715	---	---	---	---	---	164	2190	90.4	386			1872
		800	---	---	---	---	---	183	2184	91.2	386			1902
		930	---	---	---	---	---	213	2187	92.0	386			1941
50	241	---	---	---	---	---	---	54	2140	77.7	316	139	1.64	1205
		490	---	---	---	---	---	110	2144	87.0	316			1586
		545	---	---	---	---	---	123	2155	88.5	316			1617
		575	---	---	---	---	---	129	2142	88.7	316			1631
		590	---	---	---	---	---	132	2137	88.9	316			1637
		660	---	---	---	---	---	148	2141	90.1	316			1666
		770	---	---	---	---	---	172	2133	90.7	316			1702
51	200	---	---	---	---	---	---	43.2	2063	74.9	262	191	2.59	1001
		415	---	---	---	---	---	89.7	2064	85.6	262			1595
		465	---	---	---	---	---	100	2054	86.7	262			1633
		485	---	---	---	---	---	105	2067	87.1	262			1649
		500	---	---	---	---	---	108	2063	87.7	262			1657
		560	---	---	---	---	---	121	2063	88.8	262			1693
		655	---	---	---	---	---	141	2056	89.7	262			1738
52	178	---	---	---	---	---	---	41.1	2205	71.3	262	222	2.1	890
		380	---	---	---	---	---	87.7	2204	83.7	262			1487
		425	---	---	---	---	---	98	2202	85.0	262			1525
		445	---	---	---	---	---	103	2210	85.5	262			1541
		460	---	---	---	---	---	106	2201	86.1	262			1549
		515	---	---	---	---	---	119	2207	87.3	262			1583
		605	---	---	---	---	---	139	2194	88.4	262			1627
53	164	---	---	---	---	---	---	35.5	2067	70.2	230	263	2.94	822
		355	---	---	---	---	---	76.4	2055	83.0	230			1412
		395	---	---	---	---	---	85.5	2067	84.5	230			1449
		415	---	---	---	---	---	90	2071	85.1	230			1464
		425	---	---	---	---	---	92.3	2074	85.4	230			1472
		480	---	---	---	---	---	104	2069	87.0	230			1505
		565	---	---	---	---	---	122	2062	88.4	230			1548
54	154	---	---	---	---	---	---	32.5	2015	69.7	212	292	3.39	768
		330	---	---	---	---	---	70.1	2029	82.7	212			1494
		370	---	---	---	---	---	78.5	2026	84.2	212			1538
		390	---	---	---	---	---	82.7	2025	84.8	212			1557
		400	---	---	---	---	---	84.8	2025	85.1	212			1566
		450	---	---	---	---	---	95.2	2020	86.4	212			1606
		530	---	---	---	---	---	112	2018	88.1	212			1658
55	135	---	---	---	---	---	---	26.1	1846	36.5	179	387	2.8	673
		298	---	---	---	---	---	57.9	1855	80.9	179			956
		335	---	---	---	---	---	64.9	1850	82.4	179			980
		355	---	---	---	---	---	68.4	1840	83.1	179			991
		360	---	---	---	---	---	70.2	1862	83.4	179			996
		405	---	---	---	---	---	79.0	1863	84.9	179			1018
		480	---	---	---	---	---	93.1	1852	86.7	179			1047

Nota (\*) - VENTILAZIONE SOLO L.O. / FAN ONLY SIDE COMMUTATOR

Nota (°) - Regolazione di campo / Field weakening



Potenza eccitazione Excitation power (w)	3800	Tipo Size	MGL C 250 X
Cost. tempo eccitaz. Field time constant (ms)	560	Ventilazione Ventilation	IC 06
Massa del motore Mass of the motor (Kg)	1350		
Momento d'inerzia rotore Rotor inertia moment (Kgm2)	4.4		

Avv.	Velocità nominale n/min a tensione nominale di armatura Rated speed (rev/min) at rated voltage							Potenza Power kW	Coppia vel. nomin. Torque at rated speed Nm	Rendimento Efficiency %	Circuito di armatura Armature circuit			Max giri Max. speed (°)
	220	400	440	460	470	520	600				Corrente Current Amp	Res. 115°C mOhm	Ind. mH	
56		261	---	---	---	---	---	50.6	1851	79.1	160	476	5.08	1030
			293	---	---	---	---	57.0	1858	81.0	160			1064
				310	---	---	---	60.1	1851	81.7	160			1078
					320	---	---	61.7	1841	82.0	160			1085
						360	---	69.6	1846	83.7	160			1116
							425	82.2	1847	85.6	160			1156
57		230	---	---	---	---	---	44.0	1827	76.4	144	608	5.55	934
			259	---	---	---	---	49.6	1829	78.3	144			966
				274	---	---	---	52.5	1830	79.3	144			980
					282	---	---	53.9	1825	79.6	144			987
						320	---	61.0	1820	81.5	144			1016
							380	72.3	1817	83.7	144			1054
58		203	---	---	---	---	---	38.1	1792	73.3	130	768	4.87	954
			230	---	---	---	---	43.2	1794	75.5	130			994
				244	---	---	---	45.8	1793	76.6	130			1012
					251	---	---	47.1	1792	77.1	130			1020
						285	---	53.5	1793	79.1	130			1057
							340	63.7	1789	81.7	130			1104
59		184	---	---	---	---	---	34.4	1785	71.7	120	887	7.16	894
			209	---	---	---	---	39.1	1787	74.1	120			933
				222	---	---	---	41.5	1785	75.2	120			951
					228	---	---	42.7	1788	75.7	120			959
						260	---	48.6	1785	77.9	120			995
							310	58.0	1787	80.6	120			1042

Nota (\*) - VENTILAZIONE SOLO L.O. / FAN ONLY SIDE COMMUTATOR

Nota (°) - Regolazione di campo / Field weakening



Potenza eccitazione Excitation power (w)	4100	Tipo Size	MGL C 250 X2
Cost. tempo eccitaz. Field time constant (ms)	580	Ventilazione Ventilation	IC 06
Massa del motore Mass of the motor (Kg)	1460		
Momento d'inerzia rotore Rotor inertia moment (Kgm2)	4.76		

Avv.	Velocità nominale n/min a tensione nominale di armatura Rated speed (rev/min) at rated voltage							Potenza Power kW	Coppia vel. nomin. Torque at rated speed Nm	Rendimento Efficiency %	Circuito di armatura Armature circuit			Max giri Max. speed (°)	
	220	400	440	460	470	520	600				Corrente Current Amp	Res. 115°C mOhm	Ind. mH		
42	720	---	---	---	---	---	---	156	2069	88.6	800	22.1	0.27	1800	*
		1375	---	---	---	---	---	297	2063	92.8	800			1800	*
		---	1515	---	---	---	---	328	2067	93.2	800			1800	*
		---	---	1590	---	---	---	343	2060	93.2	800			1800	*
		---	---	---	1625	---	---	351	2063	93.4	800			1800	*
		---	---	---	---	1805	---	390	2063	93.8	800			1800	*
		---	---	---	---	---	---	---	---	---	---			---	---
43	610	---	---	---	---	---	---	143	2239	87.8	740	27.4	0.34	1800	
		1170	---	---	---	---	---	274	2236	92.6	740			1800	
		---	1295	---	---	---	---	303	2234	93.1	740			1800	*
		---	---	1355	---	---	---	317	2234	93.1	740			1800	*
		---	---	---	1385	---	---	324	2234	93.2	740			1800	*
		---	---	---	---	1540	---	361	2239	93.8	740			1800	*
		---	---	---	---	---	1790	418	2230	94.1	740			1800	*
44	545	---	---	---	---	---	---	129	2260	86.2	680	35.5	0.37	1800	
		1055	---	---	---	---	---	249	2254	91.5	680			1800	
		---	1170	---	---	---	---	275	2245	91.9	680			1800	
		---	---	1225	---	---	---	288	2245	92.1	680			1800	
		---	---	---	1255	---	---	295	2245	92.3	680			1800	
		---	---	---	---	1395	---	328	2245	92.8	680			1800	
		---	---	---	---	---	1620	381	2246	93.4	680			1800	
45	505	---	---	---	---	---	---	119	2250	86.5	625	38.2	0.48	1800	
		970	---	---	---	---	---	229	2254	91.6	625			1800	
		---	1075	---	---	---	---	254	2256	92.4	625			1800	
		---	---	1130	---	---	---	266	2248	92.5	625			1800	
		---	---	---	1155	---	---	272	2249	92.6	625			1800	
		---	---	---	---	1285	---	303	2252	93.2	625			1800	
		---	---	---	---	---	1495	352	2248	93.9	625			1800	
46	445	---	---	---	---	---	---	104	2232	85.2	555	46.4	0.68	1800	
		865	---	---	---	---	---	202	2230	91.0	555			1800	
		---	955	---	---	---	---	224	2240	91.7	555			1800	
		---	---	1005	---	---	---	235	2233	92.0	555			1800	
		---	---	---	1025	---	---	241	2245	92.4	555			1800	
		---	---	---	---	1145	---	268	2235	92.9	555			1800	
		---	---	---	---	---	1330	311	2233	93.4	555			1800	
47	395	---	---	---	---	---	---	91.7	2217	83.4	500	61.4	0.64	1800	
		780	---	---	---	---	---	180	2204	90.0	500			1800	
		---	865	---	---	---	---	200	2208	90.9	500			1800	
		---	---	905	---	---	---	209	2205	90.9	500			1800	
		---	---	---	925	---	---	214	2209	91.1	500			1800	
		---	---	---	---	1035	---	239	2205	91.9	500			1800	
		---	---	---	---	---	1205	278	2203	92.7	500			1800	
48	360	---	---	---	---	---	---	82	2183	82.8	452	71.2	0.86	1723	
		715	---	---	---	---	---	162	2164	89.6	452			1800	
		---	790	---	---	---	---	180	2176	90.5	452			1800	
		---	---	830	---	---	---	189	2175	90.9	452			1800	
		---	---	---	850	---	---	193	2168	90.8	452			1800	
		---	---	---	---	945	---	215	2173	91.5	452			1800	
		---	---	---	---	---	1105	251	2169	92.6	452			1800	

Nota (\*) - VENTILAZIONE SOLO L.O. / FAN ONLY SIDE COMMUTATOR

Nota (°) - Regolazione di campo / Field weakening



Potenza eccitazione Excitation power (w)	4100	Tipo	
Cost. tempo eccitaz. Field time constant (ms)	580	Size	MGL C 250 X2
Massa del motore Mass of the motor (Kg)	1460	Ventilazione Ventilation	IC 06
Momento d'inerzia rotore Rotor inertia moment (Kgm2)	4.76		

Avv.	Velocità nominale n/min a tensione nominale di armatura Rated speed (rev/min) at rated voltage							Potenza Power kW	Coppia vel. nomin. Torque at rated speed Nm	Rendimento Efficiency %	Circuito di armatura Armature circuit			Max giri Max. speed (°)		
	220	400	440	460	470	520	600				Corrente Current Amp	Res. 115°C mOhm	Ind. mH			
49	285	---	---	---	---	---	---	68.2	2285	80.3	386	97.1	1.28	1346		
		570	---	---	---	---	---	136	2278	88.1	386			1635		
		635	---	---	---	---	---	152	2286	89.5	386			1666		
		665	---	---	---	---	---	159	2283	89.5	386			1679		
		680	---	---	---	---	---	163	2289	89.8	386			1685		
		760	---	---	---	---	---	182	2287	90.7	386			1712		
		890	---	---	---	---	---	212	2275	91.5	386			1747		
		---	---	---	---	---	---	---	---	---	---			---	---	---
50	225	---	---	---	---	---	---	52.6	2232	75.7	316	151.6	1.77	1085		
		465	---	---	---	---	---	109	2238	86.2	316			1427		
		515	---	---	---	---	---	121	2244	87.0	316			1455		
		545	---	---	---	---	---	127	2225	87.4	316			1468		
		555	---	---	---	---	---	130	2237	87.5	316			1473		
		625	---	---	---	---	---	146	2231	88.9	316			1499		
		730	---	---	---	---	---	171	2237	90.2	316			1532		
		---	---	---	---	---	---	---	---	---	---			---	---	---
51	180	---	---	---	---	---	---	40.8	2165	70.8	262	224.4	2.80	901		
		385	---	---	---	---	---	87.1	2160	83.1	262			1436		
		430	---	---	---	---	---	97.3	2161	84.4	262			1470		
		455	---	---	---	---	---	102	2141	84.6	262			1484		
		465	---	---	---	---	---	105	2156	85.3	262			1491		
		525	---	---	---	---	---	118	2146	86.6	262			1524		
		615	---	---	---	---	---	138	2143	87.8	262			1564		
		---	---	---	---	---	---	---	---	---	---			---	---	---
52	165	---	---	---	---	---	---	39.5	2286	68.5	262	242.3	2.27	801		
		355	---	---	---	---	---	85.7	2305	81.8	262			1338		
		400	---	---	---	---	---	95.9	2289	83.2	262			1373		
		420	---	---	---	---	---	101	2296	83.8	262			1387		
		430	---	---	---	---	---	104	2310	84.5	262			1394		
		485	---	---	---	---	---	116	2284	85.1	262			1425		
		570	---	---	---	---	---	137	2295	87.2	262			1464		
		---	---	---	---	---	---	---	---	---	---			---	---	---
53	155	---	---	---	---	---	---	34.6	2132	68.4	230	281.2	3.18	740		
		335	---	---	---	---	---	75.4	2149	82.0	230			1271		
		375	---	---	---	---	---	84.4	2149	83.4	230			1304		
		395	---	---	---	---	---	88.9	2149	84.0	230			1318		
		405	---	---	---	---	---	91.2	2150	84.4	230			1325		
		455	---	---	---	---	---	103	2162	86.1	230			1355		
		535	---	---	---	---	---	121	2160	87.7	230			1393		
		---	---	---	---	---	---	---	---	---	---			---	---	---
54	135	---	---	---	---	---	---	30.4	2150	65.2	212	337.2	3.67	691		
		305	---	---	---	---	---	67.8	2123	80.0	212			1345		
		345	---	---	---	---	---	76.1	2106	81.6	212			1384		
		365	---	---	---	---	---	80.3	2101	82.3	212			1401		
		375	---	---	---	---	---	82.4	2098	82.7	212			1409		
		420	---	---	---	---	---	92.7	2108	84.1	212			1445		
		495	---	---	---	---	---	109	2103	85.7	212			1492		
		---	---	---	---	---	---	---	---	---	---			---	---	---
55	275	---	---	---	---	---	---	55.6	1931	77.7	179	465.9	3.03	860		
		310	---	---	---	---	---	62.4	1922	79.2	179			882		
		330	---	---	---	---	---	65.8	1904	79.9	179			892		
		340	---	---	---	---	---	67.6	1899	80.4	179			896		
		380	---	---	---	---	---	76.0	1910	81.7	179			916		
		445	---	---	---	---	---	89.4	1918	83.2	179			942		
		---	---	---	---	---	---	---	---	---	---			---	---	---
		---	---	---	---	---	---	---	---	---	---			---	---	---

Nota (\*) - VENTILAZIONE SOLO L.O. / FAN ONLY SIDE COMMUTATOR

Nota (°) - Regolazione di campo / Field weakening



Potenza eccitazione Excitation power (w) 4100	Tipo Size MGL C 250 X2
Cost. tempo eccitaz. Field time constant (ms) 580	Ventilazione Ventilation IC 06
Massa del motore Mass of the motor (Kg) 1460	
Momento d'inerzia rotore Rotor inertia moment (Kgm2) 4.76	

Avv.	Velocità nominale n/min a tensione nominale di armatura Rated speed (rev/min) at rated voltage							Potenza Power kW	Coppia vel. nomin. Torque at rated speed Nm	Rendimento Efficiency %	Circuito di armatura Armature circuit			Max giri Max. speed (°)
	220	400	440	460	470	520	600				Corrente Current Amp	Res. 115°C mOhm	Ind. mH	
56		245	---	---	---	---	---	48.5	1890	75.8	160	545.8	5.49	927
			280	---	---	---	---	54.7	1866	77.7	160			958
				295	---	---	---	57.8	1871	78.5	160			970
					300	---	---	59.4	1891	79.0	160			977
						340	---	67.2	1887	80.8	160			1004
							405	79.7	1879	83.0	160			1040
57		215	---	---	---	---	---	42.8	1901	74.3	144	655.2	6.00	841
			245	---	---	---	---	48.4	1887	76.4	144			869
				255	---	---	---	51.2	1917	77.3	144			882
					265	---	---	52.7	1899	77.9	144			888
						300	---	59.7	1900	79.7	144			914
							355	71.0	1910	82.2	144			949
58		190	---	---	---	---	---	36.2	1819	69.6	130	830.7	5.27	859
			215	---	---	---	---	41.0	1821	71.7	130			896
				225	---	---	---	43.5	1846	72.7	130			911
					235	---	---	44.7	1816	73.2	130			918
						265	---	50.8	1831	75.1	130			951
							315	60.5	1834	77.6	130			994
59		165	---	---	---	---	---	32.0	1852	66.7	120	1023.9	7.74	805
			190	---	---	---	---	36.6	1840	69.3	120			840
				200	---	---	---	39.0	1862	70.7	120			856
					205	---	---	40.1	1868	71.1	120			863
						235	---	45.9	1865	73.6	120			896
							285	55.2	1850	76.7	120			938

Nota (\*) - VENTILAZIONE SOLO L.O. / FAN ONLY SIDE COMMUTATOR

Nota (°) - Regolazione di campo / Field weakening



Potenza eccitazione Excitation power (w) 4400	Tipo Size MGL C 250 X4
Cost. tempo eccitaz. Field time constant (ms) 610	Ventilazione Ventilation IC 06
Massa del motore Mass of the motor (Kg) 1580	
Momento d'inerzia rotore Rotor inertia moment (Kgm2) 5.75	

Avv.	Velocità nominale n/min a tensione nominale di armatura Rated speed (rev/min) at rated voltage							Potenza Power kW	Coppia vel. nomin. Torque at rated speed Nm	Rendimento Efficiency %	Circuito di armatura Armature circuit			Max giri Max. speed (°)	
	220	400	440	460	470	520	600				Corrente Current Amp	Res. 115°C mOhm	Ind. mH		
42	720	---	---	---	---	---	---	154	2043	87.5	800	25.0	0.33	1458	*
		1140	---	---	---	---	---	296	2480	92.5	800			1458	*
		---	1260	---	---	---	---	327	2478	92.9	800			1458	*
		---	---	1325	---	---	---	343	2472	93.2	800			1458	*
		---	---	---	1355	---	---	351	2474	93.4	800			1458	*
		---	---	---	---	1505	---	390	2475	93.8	800			1458	*
43	505	---	---	---	---	---	---	142	2685	87.2	740	30.9	0.41	1458	
		970	---	---	---	---	---	272	2678	91.9	740			1458	
		---	1075	---	---	---	---	301	2674	92.4	740			1458	*
		---	---	1125	---	---	---	316	2682	92.8	740			1458	*
		---	---	---	1150	---	---	323	2682	92.9	740			1458	*
		---	---	---	---	1280	---	360	2686	93.6	740			1458	*
44	450	---	---	---	---	---	---	127	2695	84.9	680	40.0	0.45	1458	
		875	---	---	---	---	---	247	2696	90.8	680			1458	
		---	970	---	---	---	---	274	2697	91.6	680			1458	
		---	---	1020	---	---	---	287	2687	91.8	680			1458	
		---	---	---	1040	---	---	294	2700	92.0	680			1458	
		---	---	---	---	1160	---	327	2692	92.5	680			1458	
45	415	---	---	---	---	---	---	117	2692	85.1	625	43.1	0.58	1458	
		805	---	---	---	---	---	228	2705	91.2	625			1458	
		---	895	---	---	---	---	253	2699	92.0	625			1458	
		---	---	935	---	---	---	265	2707	92.2	625			1458	
		---	---	---	960	---	---	271	2696	92.3	625			1458	
		---	---	---	---	1070	---	302	2695	92.9	625			1458	
46	365	---	---	---	---	---	---	103	2695	84.4	555	52.3	0.82	1458	
		715	---	---	---	---	---	201	2685	90.5	555			1458	
		---	795	---	---	---	---	223	2679	91.3	555			1458	
		---	---	835	---	---	---	234	2676	91.7	555			1458	
		---	---	---	850	---	---	239	2685	91.6	555			1458	
		---	---	---	---	950	---	267	2684	92.5	555			1458	
47	325	---	---	---	---	---	---	89.9	2642	81.7	500	69.2	0.77	1458	
		645	---	---	---	---	---	179	2650	89.5	500			1458	
		---	715	---	---	---	---	198	2644	90.0	500			1458	
		---	---	750	---	---	---	208	2648	90.4	500			1458	
		---	---	---	770	---	---	213	2642	90.6	500			1458	
		---	---	---	---	855	---	238	2658	91.5	500			1458	
48	295	---	---	---	---	---	---	80.6	2609	81.1	452	80.4	1.04	1396	
		590	---	---	---	---	---	161	2606	89.0	452			1458	
		---	655	---	---	---	---	178	2595	89.5	452			1458	
		---	---	690	---	---	---	187	2588	89.9	452			1458	
		---	---	---	705	---	---	192	2601	90.4	452			1458	
		---	---	---	---	785	---	214	2603	91.0	452			1458	
					915	250	2609	92.2	452	1458					

Nota (\*) - VENTILAZIONE SOLO L.O. / FAN ONLY SIDE COMMUTATOR

Nota (°) - Regolazione di campo / Field weakening



Potenza eccitazione Excitation power (w)	4400	Tipo Size Ventilazione Ventilation	MGL C 250 X4 IC 06
Cost. tempo eccitaz. Field time constant (ms)	610		
Massa del motore Mass of the motor (Kg)	1580		
Momento d'inerzia rotore Rotor inertia moment (Kgm2)	5.75		

Avv.	Velocità nominale n/min a tensione nominale di armatura Rated speed (rev/min) at rated voltage							Potenza Power kW	Coppia vel. nomin. Torque at rated speed Nm	Rendimento Efficiency %	Circuito di armatura Armature circuit			Max giri Max. speed (°)	
	220	400	440	460	470	520	600				Corrente Current Amp	Res. 115°C mOhm	Ind. mH		
49	230	---	---	---	---	---	---	66.6	2765	78.4	386	109.5	1.55	1090	
		470	---	---	---	---	---	135	2743	87.4	386				
		525	---	---	---	---	---	150	2728	88.3	386				
		550	---	---	---	---	---	158	2743	89.0	386				
		565	---	---	---	---	---	162	2738	89.3	386				
		630	---	---	---	---	---	181	2744	90.2	386				
		735	---	---	---	---	---	211	2741	91.1	386				
		---	---	---	---	---	---	---	---	---	---				---
50	180	---	---	---	---	---	---	50.8	2695	73.1	316	171.3	2.14	879	
		380	---	---	---	---	---	107	2689	84.7	316				
		425	---	---	---	---	---	119	2674	85.6	316				
		450	---	---	---	---	---	125	2653	86.0	316				
		460	---	---	---	---	---	129	2678	86.9	316				
		515	---	---	---	---	---	144	2670	87.6	316				
		605	---	---	---	---	---	169	2668	89.1	316				
		---	---	---	---	---	---	---	---	---	---				---
51	145	---	---	---	---	---	---	38.9	2562	67.5	262	253.4	3.38	730	
		315	---	---	---	---	---	85.3	2586	81.4	262				
		355	---	---	---	---	---	95.6	2572	82.9	262				
		375	---	---	---	---	---	101	2572	83.8	262				
		385	---	---	---	---	---	103	2555	83.6	262				
		430	---	---	---	---	---	116	2576	85.1	262				
		505	---	---	---	---	---	137	2591	87.2	262				
		---	---	---	---	---	---	---	---	---	---				---
52	130	---	---	---	---	---	---	37.5	2755	65.1	262	273.5	2.74	649	
		290	---	---	---	---	---	83.8	2759	80.0	262				
		325	---	---	---	---	---	94.1	2765	81.6	262				
		345	---	---	---	---	---	99.2	2746	82.3	262				
		355	---	---	---	---	---	102	2744	82.8	262				
		400	---	---	---	---	---	115	2745	84.4	262				
		470	---	---	---	---	---	135	2743	85.9	262				
		---	---	---	---	---	---	---	---	---	---				---
53	120	---	---	---	---	---	---	32.8	2610	64.8	230	317.4	3.84	599	
		270	---	---	---	---	---	73.6	2603	80.0	230				
		305	---	---	---	---	---	82.7	2589	81.7	230				
		320	---	---	---	---	---	87.2	2602	82.4	230				
		330	---	---	---	---	---	89.5	2590	82.8	230				
		370	---	---	---	---	---	101	2607	84.4	230				
		440	---	---	---	---	---	119	2583	86.2	230				
		---	---	---	---	---	---	---	---	---	---				---
54	250	---	---	---	---	---	---	66.0	2521	77.8	212	380.9	4.43	1089	
		280	---	---	---	---	---	74.4	2537	79.8	212				
		295	---	---	---	---	---	78.6	2544	80.6	212				
		305	---	---	---	---	---	80.6	2524	80.9	212				
		345	---	---	---	---	---	91.0	2519	82.5	212				
		405	---	---	---	---	---	108	2547	84.9	212				
		---	---	---	---	---	---	---	---	---	---				---
		---	---	---	---	---	---	---	---	---	---				---
55	225	---	---	---	---	---	---	54.1	2296	75.6	179	526.5	3.66	697	
		250	---	---	---	---	---	61.0	2330	77.5	179				
		265	---	---	---	---	---	64.4	2321	78.2	179				
		275	---	---	---	---	---	66.1	2295	78.6	179				
		310	---	---	---	---	---	74.6	2298	80.1	179				
		365	---	---	---	---	---	88.6	2318	82.5	179				
		---	---	---	---	---	---	---	---	---	---				---
		---	---	---	---	---	---	---	---	---	---				---

Nota (\*) - VENTILAZIONE SOLO L.O. / FAN ONLY SIDE COMMUTATOR

Nota (°) - Regolazione di campo / Field weakening





Potenza eccitazione Excitation power (w) 4400	Tipo Size MGL C 250 X4
Cost. tempo eccitaz. Field time constant (ms) 610	Ventilazione Ventilation IC 06
Massa del motore Mass of the motor (Kg) 1580	
Momento d'inerzia rotore Rotor inertia moment (Kgm2) 5.75	

Avv.	Velocità nominale n/min a tensione nominale di armatura Rated speed (rev/min) at rated voltage							Potenza Power kW	Coppia vel. nomin. Torque at rated speed Nm	Rendimento Efficiency %	Circuito di armatura Armature circuit			Max giri Max. speed (°)
	220	400	440	460	470	520	600				Corrente Current Amp	Res. 115°C mOhm	Ind. mH	
56	200	----	----	----	----	----	46.8	2235	73.1	160	616.6	8.01	751	
		225	----	----	----	53.1	2254	75.4	160					
		240	----	----	----	56.3	2240	76.5	160					
			245	----	----	57.8	2253	76.9	160					
		280	----	----	----	65.7	2241	79.0	160					
			330	----	----	78.2	2263	81.5	160					
		57	170	----	----	----	----	----	41.2	2314				71.5
195	----			----	----	46.8	2292	73.9	144					
210	----			----	----	49.6	2256	74.9	144					
	215			----	----	51.1	2270	75.5	144					
245	----			----	----	58.1	2265	77.6	144					
	290			----	----	69.5	2289	80.4	144					
58	155			----	----	----	----	----	35.1	2163	67.5	130	937.9	7.68
		180	----	----	----	39.8	2112	69.6	130					
		185	----	----	----	42.2	2178	70.6	130					
			195	----	----	43.4	2125	71.0	130					
		220	----	----	----	49.3	2140	72.9	130					
			260	----	----	58.7	2156	75.3	130					
		59	130	----	----	----	----	----	30.3	2226	63.1	120		
150	----			----	----	34.9	2222	66.1	120					
160	----			----	----	37.3	2226	67.6	120					
	165			----	----	38.4	2222	68.1	120					
190	----			----	----	44.3	2227	71.0	120					
	230			----	----	53.6	2225	74.4	120					

Nota (\*) - VENTILAZIONE SOLO L.O. / FAN ONLY SIDE COMMUTATOR

Nota (°) - Regolazione di campo / Field weakening



Potenza eccitazione  
Excitation power (w) 2200  
Cost. tempo eccitaz.  
Field time constant (ms) 430  
Massa del motore  
Mass of the motor (Kg) 1195  
Momento d'inerzia rotore  
Rotor inertia moment (Kgm2) 5.9

Tipo  
Size MGL C 280 S  
Ventilazione  
Ventilation IC 06

Avv.	Velocità nominale n/min a tensione nominale di armatura Rated speed (rev/min) at rated voltage							Potenza Power kW	Coppia vel.nomin. Torque at rated speed Nm	Rendimento Efficiency %	Circuito di armatura circuit			Max giri Max. speed (°)	
	400	440	460	520	600	700	810				Corrente Current Amp	Res. 115°C mOhm	Ind. mH		
41	2415	---	---	---	---	---	---	457	1806	95.6	1195	8.2	0.099	2500	*
42	2230	---	---	---	---	---	---	422	1805	95.4	1105	9.6	0.116	2500	*
		2460	---	---	---	---	---	465	1806	95.7	1105			2500	*
43	2070	---	---	---	---	---	---	392	1809	95.2	1030	11.0	0.134	2500	*
		2285	---	---	---	---	---	433	1809	95.5	1030			2500	*
		2395	---	---	---	---	---	453	1807	95.6	1030			2500	*
44	1935	---	---	---	---	---	---	367	1809	95.0	965	12.6	0.153	2500	*
		2135	---	---	---	---	---	405	1810	95.3	965			2500	*
		2235	---	---	---	---	---	424	1811	95.5	965			2500	*
45	1815	---	---	---	---	---	---	343	1805	94.8	905	14.3	0.174	2500	*
		2000	---	---	---	---	---	379	1809	95.1	905			2500	*
		2095	---	---	---	---	---	397	1808	95.3	905			2500	*
		2380	---	---	---	---	---	450	1807	95.7	905			2500	*
46	1705	---	---	---	---	---	---	323	1812	94.6	855	16.1	0.196	2500	*
		1885	---	---	---	---	---	357	1810	95.0	855			2500	*
		1975	---	---	---	---	---	374	1809	95.1	855			2500	*
		2240	---	---	---	---	---	425	1811	95.5	855			2500	*
47	1610	---	---	---	---	---	---	306	1814	94.4	810	18.0	0.219	2500	*
		1780	---	---	---	---	---	338	1812	94.8	810			2500	*
		1865	---	---	---	---	---	354	1811	94.9	810			2500	*
		2115	---	---	---	---	---	402	1814	95.4	810			2500	*
		2450	---	---	---	---	---	466	1815	95.8	810			2500	*

Nota (\*) - VENTILAZIONE SOLO L.O. / FAN ONLY SIDE COMMUTATOR

Nota (°) - Regolazione di campo / Field weakening

CEAR S.r.l. - Via Valchiampo,14 - 36050 MONTORSO (Vicenza) - Italy

Telefoni 0039 0444 685505 - 685062 - Fax 0039 0444 686190 - [www.cearmotors.com](http://www.cearmotors.com) - [info@cearmotors.com](mailto:info@cearmotors.com)



Potenza eccitazione  
Excitation power (w) 2200  
Cost. tempo eccitaz.  
Field time constant (ms) 430  
Massa del motore  
Mass of the motor (Kg) 1195  
Momento d'inerzia rotore  
Rotor inertia moment (Kgm2) 5.9

Tipo  
Size MGL C 280 S  
Ventilazione  
Ventilation IC 06

Avv.	Velocità nominale n/min a tensione nominale di armatura Rated speed (rev/min) at rated voltage							Potenza Power kW	Coppia vel.nomin. Torque at rated speed Nm	Rendimento Efficiency %	Circuito di armatura Armature circuit			Max giri Max. speed (°)	
	400	440	460	520	600	700	810				Corrente Current Amp	Res. 115°C mOhm	Ind. mH		
48	1590	---	---	---	---	---	---	302	1813	94.3	800	18.4	0.225	2500	*
		1755	---	---	---	---	---	333	1814	94.7	800			2500	
		---	1835	---	---	---	---	349	1818	94.9	800			2500	
		---	---	2085	---	---	---	397	1817	95.3	800			2500	
		---	---	---	2420	---	---	460	1814	95.8	800			2500	
49	1465	---	---	---	---	---	---	278	1815	94.0	740	21.5	0.263	2500	*
		1620	---	---	---	---	---	308	1813	94.5	740			2500	
		---	1695	---	---	---	---	322	1815	94.7	740			2500	
		---	---	1930	---	---	---	366	1811	95.1	740			2500	
		---	---	---	2235	---	---	424	1813	95.6	740			2500	
50	1360	---	---	---	---	---	---	259	1817	93.7	690	24.8	0.304	2500	*
		1505	---	---	---	---	---	286	1815	94.2	690			2500	
		---	1575	---	---	---	---	300	1817	94.4	690			2500	
		---	---	1790	---	---	---	340	1816	94.9	690			2500	
		---	---	---	2075	---	---	395	1818	95.4	690			2500	
		---	---	---	---	2435	---	463	1816	95.9	690			2500	
51	1270	---	---	---	---	---	---	239	1800	93.5	640	28.4	0.351	2500	*
		1405	---	---	---	---	---	265	1798	94.0	640			2500	
		---	1470	---	---	---	---	277	1800	94.2	640			2500	
		---	---	1670	---	---	---	315	1802	94.7	640			2500	
		---	---	---	1940	---	---	366	1800	95.2	640			2500	
		---	---	---	---	2275	---	429	1800	95.7	640			2500	
52	1190	---	---	---	---	---	---	224	1795	93.2	600	32.1	0.399	2472	*
		1315	---	---	---	---	---	247	1797	93.7	600			2500	
		---	1380	---	---	---	---	259	1794	93.9	600			2500	
		---	---	1565	---	---	---	295	1798	94.5	600			2500	
		---	---	---	1820	---	---	342	1795	95.0	600			2500	
		---	---	---	---	2135	---	401	1795	95.6	600			2500	
		---	---	---	---	---	2480	466	1796	96.0	600			2500	
		---	---	---	---	---	---	---	---	---	---			---	
53	1115	---	---	---	---	---	---	212	1814	92.9	570	36.2	0.447	2316	*
		1235	---	---	---	---	---	234	1811	93.4	570			2358	
		---	1295	---	---	---	---	246	1810	93.6	570			2378	
		---	---	1475	---	---	---	279	1808	94.2	570			2415	
		---	---	---	1710	---	---	324	1810	94.8	570			2451	
		---	---	---	---	2005	---	381	1812	95.4	570			2487	
		---	---	---	---	---	2335	442	1809	95.8	570			2500	
		---	---	---	---	---	---	---	---	---	---			---	
54	1085	---	---	---	---	---	---	206	1812	92.7	555	38.3	0.473	2254	*
		1200	---	---	---	---	---	228	1813	93.3	555			2291	
		---	1255	---	---	---	---	239	1816	93.5	555			2304	
		---	---	1430	---	---	---	272	1813	94.1	555			2342	
		---	---	---	1660	---	---	315	1814	94.7	555			2379	
		---	---	---	---	1950	---	370	1813	95.3	555			2418	
		---	---	---	---	---	2265	430	1815	95.7	555			2445	

Nota (\*) - VENTILAZIONE SOLO L.O. / FAN ONLY SIDE COMMUTATOR

Nota (°) - Regolazione di campo / Field weakening

CEAR S.r.l. - Via Valchiampo,14 - 36050 MONTORSO (Vicenza) - Italy

Telefoni 0039 0444 685505 - 685062 - Fax 0039 0444 686190 - www.cearmotors.com - info@cearmotors.com



Potenza eccitazione  
Excitation power (w) 2200  
Cost. tempo eccitaz.  
Field time constant (ms) 430  
Massa del motore  
Mass of the motor (Kg) 1195  
Momento d'inerzia rotore  
Rotor inertia moment (Kgm2) 5.9

Tipo  
Size MGL C 280 S  
Ventilazione  
Ventilation IC 06

Avv.	Velocità nominale n/min a tensione nominale di armatura Rated speed (rev/min) at rated voltage							Potenza Power kW	Coppia vel.nomin. Torque at rated speed Nm	Rendimento Efficiency %	Circuito di armatura Armature circuit			Max giri Max. speed (°)	
	400	440	460	520	600	700	810				Corrente Current Amp	Res. 115°C mOhm	Ind. mH		
55	1005	---	---	---	---	---	---	190	1808	92.4	515	44.1	0.550	2330	*
		1115	---	---	---	---	---	211	1804	92.9	515			2453	
		---	1165	---	---	---	---	221	1809	93.2	515			2500	
		---	---	1330	---	---	---	251	1804	93.8	515			2500	
		---	---	---	1545	---	---	292	1804	94.5	515			2500	
		---	---	---	---	1810	---	343	1808	95.1	515			2500	
		---	---	---	---	---	2105	399	1808	95.6	515			2500	
		---	---	---	---	---	---	---	---	---	---			---	
		---	---	---	---	---	---	---	---	---	---			---	
56	935	---	---	---	---	---	---	177	1804	92.0	480	50.4	0.633	2338	*
		1035	---	---	---	---	---	196	1804	92.6	480			2277	
		---	1090	---	---	---	---	205	1796	92.9	480			2180	
		---	---	1240	---	---	---	233	1798	93.5	480			2356	
		---	---	---	1440	---	---	271	1799	94.2	480			2448	
		---	---	---	---	1690	---	319	1800	94.9	480			2500	
		---	---	---	---	---	1965	371	1802	95.4	480			2500	
		---	---	---	---	---	---	---	---	---	---			---	
		---	---	---	---	---	---	---	---	---	---			---	
57	875	---	---	---	---	---	---	167	1818	91.5	455	57.2	0.714	2188	*
		970	---	---	---	---	---	185	1817	92.2	455			2135	
		---	1015	---	---	---	---	194	1821	92.5	455			2030	
		---	---	1160	---	---	---	221	1815	93.2	455			2204	
		---	---	---	1350	---	---	256	1814	93.9	455			2295	
		---	---	---	---	1585	---	301	1815	94.6	455			2500	
		---	---	---	---	---	1845	351	1815	95.2	455			2500	
		---	---	---	---	---	---	---	---	---	---			---	
		---	---	---	---	---	---	---	---	---	---			---	
58	820	---	---	---	---	---	---	157	1826	91.1	430	64.3	0.804	2050	*
		910	---	---	---	---	---	174	1823	91.8	430			2002	
		---	955	---	---	---	---	182	1822	92.1	430			1910	
		---	---	1090	---	---	---	208	1820	92.9	430			2071	
		---	---	---	1265	---	---	242	1824	93.7	430			2151	
		---	---	---	---	1490	---	284	1821	94.4	430			2500	
		---	---	---	---	---	1735	331	1821	95.0	430			2500	
		---	---	---	---	---	---	---	---	---	---			---	
		---	---	---	---	---	---	---	---	---	---			---	
59	775	---	---	---	---	---	---	147	1813	90.8	405	71.8	0.906	1937	*
		860	---	---	---	---	---	163	1811	91.5	405			1892	
		---	900	---	---	---	---	171	1815	91.8	405			1800	
		---	---	1025	---	---	---	195	1817	92.6	405			1948	
		---	---	---	1195	---	---	227	1814	93.4	405			2032	
		---	---	---	---	1405	---	267	1815	94.2	405			2389	
		---	---	---	---	---	1640	311	1811	94.8	405			2460	
		---	---	---	---	---	---	---	---	---	---			---	
		---	---	---	---	---	---	---	---	---	---			---	

Nota (\*) - VENTILAZIONE SOLO L.O. / FAN ONLY SIDE COMMUTATOR

Nota (°) - Regolazione di campo / Field weakening

CEAR S.r.l. - Via Valchiampo,14 - 36050 MONTORSO (Vicenza) - Italy

Telefoni 0039 0444 685505 - 685062 - Fax 0039 0444 686190 - www.cearmotors.com - info@cearmotors.com



Potenza eccitazione Excitation power	(w)	2500	Tipo Size Ventilazione Ventilation	MGL C 280 M   IC 06
Cost. tempo eccitaz. Field time constant	(ms)	470		
Massa del motore Mass of the motor	(Kg)	1350		
Momento d'inerzia rotore Rotor inertia moment	(Kgm2)	6.6		

Avv.	Velocità nominale n/min a tensione nominale di armatura Rated speed (rev/min) at rated voltage							Potenza Power kW	Coppia vel.nomin. Torque at rated speed Nm	Rendimento Efficiency %	Circuito di armatura circuit			Max giri Max. speed (°)	*	
	400	440	460	520	600	700	810				Corrente Current Amp	Res. 115°C mOhm	Ind. mH			
39	2395	---	---	---	---	---	---	543	2164	95.5	1420	6.9	0.084	2500	*	
40	2180	---	---	---	---	---	---	496	2171	95.3	1300	8.3	0.101	2500	*	
			2405	---	---	---	---	---	547	2171	95.6			1300	2500	*
			2520	---	---	---	---	---	572	2169	95.7			1300	2500	*
41	2000	---	---	---	---	---	---	454	2170	95.1	1195	9.8	0.119	2500	*	
			2210	---	---	---	---	---	502	2167	95.4			1195	2500	*
			2310	---	---	---	---	---	525	2171	95.5			1195	2500	*
42	1850	---	---	---	---	---	---	419	2164	94.8	1105	11.5	0.140	2500	*	
			2040	---	---	---	---	---	463	2166	95.2			1105	2500	*
			2140	---	---	---	---	---	485	2162	95.3			1105	2500	*
				2425	---	---	---	---	---	550	2166			95.7	1105	2500
43	1715	---	---	---	---	---	---	390	2170	94.6	1030	13.2	0.161	2500	*	
			1900	---	---	---	---	---	430	2163	95.0			1030	2500	*
			1985	---	---	---	---	---	451	2168	95.2			1030	2500	*
				2255	---	---	---	---	---	512	2167			95.6	1030	2500
			2610	---	---	---	---	---	593	2170	96.0			1030	2500	*
44	1600	---	---	---	---	---	---	364	2174	94.4	965	15.1	0.185	2500	*	
			1770	---	---	---	---	---	402	2171	94.7			965	2500	*
			1855	---	---	---	---	---	421	2169	94.9			965	2500	*
				2105	---	---	---	---	---	478	2171			95.3	965	2500
			2440	---	---	---	---	---	555	2171	95.8			965	2500	*
45	1500	---	---	---	---	---	---	341	2169	94.1	905	17.1	0.217	2500	*	
			1660	---	---	---	---	---	376	2166	94.6			905	2500	*
			1735	---	---	---	---	---	394	2170	94.7			905	2500	*
				1975	---	---	---	---	---	448	2166			95.2	905	2500
			2290	---	---	---	---	---	519	2166	95.7			905	2500	*

Nota (\*) - VENTILAZIONE SOLO L.O. / FAN ONLY SIDE COMMUTATOR

Nota (°) - Regolazione di campo / Field weakening

CEAR S.r.l. - Via Valchiampo,14 - 36050 MONTORSO (Vicenza) - Italy

Telefoni 0039 0444 685505 - 685062 - Fax 0039 0444 686190 - [www.cearmotors.com](http://www.cearmotors.com) - [info@cearmotors.com](mailto:info@cearmotors.com)



Potenza eccitazione Excitation power	(w)	2500	Tipo Size	MGL C 280 M
Cost. tempo eccitaz. Field time constant	(ms)	470		
Massa del motore Mass of the motor	(Kg)	1350	Ventilazione Ventilation	IC 06
Momento d'inerzia rotore Rotor inertia moment	(Kgm2)	6.6		

Avv.	Velocità nominale n/min a tensione nominale di armatura Rated speed (rev/min) at rated voltage							Potenza Power kW	Coppia vel.nomin. Torque at rated speed Nm	Rendimento Efficiency %	Circuito di armatura Armature circuit			Max giri Max. speed (°)	
	400	440	460	520	600	700	810				Corrente Current Amp	Res. 115°C mOhm	Ind. mH		
46	1410	---	---	---	---	---	---	321	2175	93.9	855	19.3	0.236	2500	
		1560	---	---	---	---	---	355	2172	94.3	855			2500	*
		---	1635	---	---	---	---	372	2171	94.5	855			2500	*
		---	---	1855	---	---	---	422	2174	95.0	855			2500	*
		---	---	---	2155	---	---	490	2171	95.5	855			2500	*
47	1330	---	---	---	---	---	---	303	2179	93.6	810	21.6	0.264	2500	
		1470	---	---	---	---	---	335	2179	94.1	810			2500	
		---	1540	---	---	---	---	351	2179	94.3	810			2500	
		---	---	1755	---	---	---	399	2173	94.8	810			2500	*
		---	---	---	2035	---	---	463	2174	95.3	810			2500	*
48	1315	---	---	---	---	---	---	299	2175	93.6	800	22.1	0.271	2500	
		1450	---	---	---	---	---	331	2180	94.1	800			2500	
		---	1520	---	---	---	---	347	2179	94.3	800			2500	
		---	---	1730	---	---	---	394	2176	94.8	800			2500	
		---	---	---	2005	---	---	457	2178	95.3	800			2500	*
49	1210	---	---	---	---	---	---	276	2178	93.2	740	25.8	0.318	2500	
		1340	---	---	---	---	---	305	2175	93.7	740			2500	
		---	1405	---	---	---	---	320	2174	94.0	740			2500	
		---	---	1595	---	---	---	364	2177	94.5	740			2500	
		---	---	---	1850	---	---	422	2179	95.1	740			2500	
50	1125	---	---	---	---	---	---	256	2176	92.9	690	29.8	0.367	2337	*
		1245	---	---	---	---	---	284	2175	93.4	690			2377	*
		---	1305	---	---	---	---	297	2175	93.6	690			2396	*
		---	---	1480	---	---	---	338	2181	94.2	690			2424	*
		---	---	---	1720	---	---	393	2179	94.8	690			2465	*
51	1050	---	---	---	---	---	---	237	2155	92.6	640	34.0	0.425	2181	
		1160	---	---	---	---	---	262	2159	93.1	640			2215	
		---	1215	---	---	---	---	275	2160	93.4	640			2231	
		---	---	1385	---	---	---	313	2157	94.0	640			2268	
		---	---	---	1605	---	---	363	2161	94.6	640			2300	*
52	980	---	---	---	---	---	---	221	2157	92.3	600	38.6	0.484	2035	
		1085	---	---	---	---	---	245	2157	92.8	600			2072	
		---	1140	---	---	---	---	257	2152	93.1	600			2093	
		---	---	1295	---	---	---	292	2156	93.7	600			2121	
		---	---	---	1505	---	---	340	2156	94.4	600			2157	
						1765	---	399	2159	95.0	600		2189	*	
						2055	464	2157	95.5	600			2218	*	

Nota (\*) - VENTILAZIONE SOLO L.O. / FAN ONLY SIDE COMMUTATOR

Nota (°) - Regolazione di campo / Field weakening

CEAR S.r.l. - Via Valchiampo,14 - 36050 MONTORSO (Vicenza) - Italy

Telefoni 0039 0444 685505 - 685062 - Fax 0039 0444 686190 - www.cearmotors.com - info@cearmotors.com



Potenza eccitazione  
Excitation power (w) 2500  
Cost. tempo eccitaz.  
Field time constant (ms) 470  
Massa del motore  
Mass of the motor (Kg) 1350  
Momento d'inerzia rotore  
Rotor inertia moment (Kgm2) 6.6

Tipo  
Size MGL C 280 M  
Ventilazione  
Ventilation IC 06

Avv.	Velocità nominale n/min a tensione nominale di armatura Rated speed (rev/min) at rated voltage							Potenza Power kW	Coppia vel.nomin. Torque at rated speed Nm	Rendimento Efficiency %	Circuito di armatura Armature circuit			Max giri Max. speed (°)	
	400	440	460	520	600	700	810				Corrente Current Amp	Res. 115°C mOhm	Ind. mH		
53	920	---	---	---	---	---	---	209	2174	91.9	570	43.4	0.542	2300	
		1020	---	---	---	---	---	232	2172	92.5	570			2243	
		---	1070	---	---	---	---	243	2170	92.8	570			2140	
		---	---	1215	---	---	---	277	2176	93.4	570			2309	
		---	---	---	1415	---	---	322	2172	94.1	570			2406	
		---	---	---	---	1660	---	378	2175	94.8	570			2500	
		---	---	---	---	---	1935	440	2172	95.3	570			2500	*
		---	---	---	---	---	---	---	---	---	---			---	---
54	895	---	---	---	---	---	---	203	2171	91.7	555	45.9	0.574	2238	
		990	---	---	---	---	---	225	2175	92.3	555			2177	
		---	1040	---	---	---	---	236	2170	92.6	555			2080	
		---	---	1180	---	---	---	269	2179	93.3	555			2242	
		---	---	---	1375	---	---	313	2174	94.0	555			2338	
		---	---	---	---	1615	---	368	2175	94.7	555			2500	
		---	---	---	---	---	1880	428	2174	95.2	555			2500	---
		---	---	---	---	---	---	---	---	---	---			---	---
55	830	---	---	---	---	---	---	188	2162	91.2	515	53.0	0.667	2075	
		915	---	---	---	---	---	208	2173	91.9	515			2013	
		---	960	---	---	---	---	218	2172	92.2	515			1920	
		---	---	1100	---	---	---	249	2161	93.0	515			2090	
		---	---	---	1275	---	---	290	2168	93.7	515			2168	
		---	---	---	---	1500	---	340	2167	94.4	515			2500	
		---	---	---	---	---	1745	396	2168	95.0	515			2500	*
		---	---	---	---	---	---	---	---	---	---			---	---
56	770	---	---	---	---	---	---	174	2161	90.8	480	60.5	0.768	1925	
		855	---	---	---	---	---	193	2158	91.5	480			1881	
		---	900	---	---	---	---	203	2151	91.8	480			1800	
		---	---	1025	---	---	---	231	2153	92.6	480			1948	
		---	---	---	1190	---	---	269	2159	93.4	480			2023	
		---	---	---	---	1400	---	316	2158	94.2	480			2380	
		---	---	---	---	---	1630	368	2159	94.8	480			2445	*
		---	---	---	---	---	---	---	---	---	---			---	---
57	720	---	---	---	---	---	---	164	2179	90.2	455	68.6	0.868	1799	
		800	---	---	---	---	---	182	2175	91.0	455			1760	
		---	840	---	---	---	---	191	2173	91.3	455			1680	
		---	---	955	---	---	---	218	2181	92.2	455			1815	
		---	---	---	1115	---	---	254	2176	93.1	455			1896	
		---	---	---	---	1310	---	299	2180	93.9	455			2226	
		---	---	---	---	---	1525	348	2181	94.5	455			2288	---
		---	---	---	---	---	---	---	---	---	---			---	---
58	675	---	---	---	---	---	---	154	2184	89.8	430	77.1	0.978	1687	
		750	---	---	---	---	---	171	2182	90.6	430			1650	
		---	785	---	---	---	---	180	2188	91.0	430			1570	
		---	---	895	---	---	---	205	2191	91.9	430			1701	
		---	---	---	1045	---	---	239	2186	92.8	430			1777	
		---	---	---	---	1230	---	282	2187	93.6	430			2091	
		---	---	---	---	---	1435	328	2185	94.3	430			2153	---
		---	---	---	---	---	---	---	---	---	---			---	---
59	635	---	---	---	---	---	---	145	2175	89.3	405	86.2	1.10	1588	
		705	---	---	---	---	---	161	2177	90.2	405			1551	
		---	740	---	---	---	---	169	2177	90.5	405			1480	
		---	---	845	---	---	---	193	2177	91.5	405			1606	
		---	---	---	985	---	---	225	2178	92.4	405			1675	
		---	---	---	---	1160	---	265	2178	93.3	405			1972	
		---	---	---	---	---	1355	309	2175	94.0	405			2033	---
		---	---	---	---	---	---	---	---	---	---			---	---

Nota (\*) - VENTILAZIONE SOLO L.O. / FAN ONLY SIDE COMMUTATOR

Nota (°) - Regolazione di campo / Field weakening

CEAR S.r.l. - Via Valchiampo,14 - 36050 MONTORSO (Vicenza) - Italy

Telefoni 0039 0444 685505 - 685062 - Fax 0039 0444 686190 - www.cearmotors.com - info@cearmotors.com





Potenza eccitazione Excitation power	(w)	2800	Tipo Size	MGL C 280 L
Cost. tempo eccitaz. Field time constant	(ms)	490		
Massa del motore Mass of the motor	(Kg)	1530	Ventilazione Ventilation	IC 06
Momento d'inerzia rotore Rotor inertia moment	(Kgm2)	7.3		

Avv.	Velocità nominale n/min a tensione nominale di armatura Rated speed (rev/min) at rated voltage							Potenza Power kW	Coppia vel. nomin. Torque at rated speed Nm	Rendimento Efficiency %	Circuito di armatura Armature circuit			Max giri Max. speed (°)	*
	400	440	460	520	600	700	810				Corrente Current Amp	Res. 115°C mOhm	Ind. mH		
39	1995	---	---	---	---	---	---	540	2584	95.1	1420	8.3	0.101	2500	*
		2200	---	---	---	---	---	596	2587	95.4	1420			2500	*
		2305	---	---	---	---	---	624	2585	95.5	1420			2500	*
40	1815	---	---	---	---	---	---	493	2592	94.7	1300	9.9	0.121	2500	*
		2005	---	---	---	---	---	544	2591	95.1	1300			2500	*
		2100	---	---	---	---	---	570	2591	95.2	1300			2500	*
41	1665	---	---	---	---	---	---	452	2590	94.5	1195	11.8	0.143	2500	*
		1840	---	---	---	---	---	499	2589	94.9	1195			2500	*
		1926	---	---	---	---	---	522	2590	95.0	1195			2500	*
		2185	---	---	---	---	---	593	2592	95.4	1195			2500	*
42	1535	---	---	---	---	---	---	416	2590	94.2	1105	13.7	0.168	2500	*
		1700	---	---	---	---	---	460	2584	94.6	1105			2500	*
		1780	---	---	---	---	---	482	2585	94.8	1105			2500	*
		2020	---	---	---	---	---	547	2586	95.2	1105			2500	*
43	1425	---	---	---	---	---	---	387	2593	94.0	1030	15.8	0.194	2500	*
		1575	---	---	---	---	---	428	2593	94.4	1030			2500	*
		1650	---	---	---	---	---	448	2593	94.6	1030			2500	*
		1875	---	---	---	---	---	509	2592	95.0	1030			2500	*
		2176	---	---	---	---	---	590	2590	95.5	1030			2500	*
44	1330	---	---	---	---	---	---	361	2595	93.6	965	18.1	0.222	2500	*
		1470	---	---	---	---	---	400	2596	94.1	965			2500	*
		1540	---	---	---	---	---	419	2596	94.3	965			2500	*
		1750	---	---	---	---	---	476	2596	94.8	965			2500	*
		2030	---	---	---	---	---	552	2596	95.3	965			2500	*
45	1245	---	---	---	---	---	---	338	2593	93.4	905	20.5	0.253	2500	*
		1380	---	---	---	---	---	374	2586	93.9	905			2500	*
		1445	---	---	---	---	---	392	2588	94.1	905			2500	*
		1640	---	---	---	---	---	445	2592	94.6	905			2500	*
		1905	---	---	---	---	---	517	2589	95.1	905			2500	*
		2235	---	---	---	---	---	606	2589	95.6	905			2500	*

Nota (\*) - VENTILAZIONE SOLO L.O. / FAN ONLY SIDE COMMUTATOR

Nota (°) - Regolazione di campo / Field weakening

CEAR S.r.l. - Via Valchiampo,14 - 36050 MONTORSO (Vicenza) - Italy

Telefoni 0039 0444 685505 - 685062 - Fax 0039 0444 686190 - [www.cearmotors.com](http://www.cearmotors.com) - [info@cearmotors.com](mailto:info@cearmotors.com)



Potenza eccitazione Excitation power (w)	2800	Tipo Size	MGL C 280 L
Cost. tempo eccitaz. Field time constant (ms)	490		
Massa del motore Mass of the motor (Kg)	1530	Ventilazione Ventilation	IC 06
Momento d'inerzia rotore Rotor inertia moment (Kgm2)	7.3		

Avv.	Velocità nominale n/min a tensione nominale di armatura Rated speed (rev/min) at rated voltage							Potenza Power kW	Coppia vel.nomin. Torque at rated speed Nm	Rendimento Efficiency %	Circuito di armatura Armature circuit			Max giri Max. speed (°)
	400	440	460	520	600	700	810				Corrente Current Amp	Res. 115°C mOhm	Ind. mH	
46	1170	---	---	---	---	---	---	318	2598	93.1	855	23.0	0.284	2430
		1295	---	---	---	---	---	352	2596	93.6	855			2473
		---	1360	---	---	---	---	369	2591	93.8	855			2497
		---	---	1545	---	---	---	420	2593	94.4	855			2500
		---	---	---	1790	---	---	487	2598	95.0	855			2500
		---	---	---	---	---	2105	571	2592	95.5	855			2500
47	1105	---	---	---	---	---	---	301	2598	92.8	810	25.7	0.318	2295
		1225	---	---	---	---	---	333	2593	93.3	810			2339
		---	1280	---	---	---	---	349	2601	93.6	810			2350
		---	---	1460	---	---	---	397	2594	94.1	810			2391
		---	---	---	1695	---	---	460	2594	94.7	810			2429
		---	---	---	---	---	1985	540	2600	95.3	810			2462
48	1090	---	---	---	---	---	---	297	2601	92.7	800	26.4	0.327	2263
		1205	---	---	---	---	---	328	2601	93.3	800			2302
		---	1265	---	---	---	---	344	2597	93.5	800			2322
		---	---	1435	---	---	---	391	2605	94.1	800			2350
		---	---	---	1670	---	---	455	2599	94.7	800			2393
		---	---	---	---	---	1960	534	2599	95.3	800			2431
49	1005	---	---	---	---	---	---	273	2596	92.3	740	30.8	0.383	2087
		1110	---	---	---	---	---	302	2602	92.9	740			2119
		---	1165	---	---	---	---	317	2598	93.1	740			2139
		---	---	1325	---	---	---	361	2601	93.8	740			2170
		---	---	---	1540	---	---	419	2600	94.4	740			2207
		---	---	---	---	---	1810	492	2597	95.0	740			2245
50	930	---	---	---	---	---	---	254	2604	91.9	690	35.6	0.443	1932
		1030	---	---	---	---	---	281	2604	92.5	690			1967
		---	1080	---	---	---	---	294	2603	92.8	690			1983
		---	---	1230	---	---	---	335	2603	93.4	690			2014
		---	---	---	1430	---	---	390	2602	94.1	690			2050
		---	---	---	---	---	1680	458	2602	94.8	690			2084
51	865	---	---	---	---	---	---	234	2586	91.5	640	40.7	0.513	1797
		960	---	---	---	---	---	260	2582	92.2	640			1833
		---	1005	---	---	---	---	272	2586	92.4	640			1845
		---	---	1145	---	---	---	310	2586	93.2	640			1875
		---	---	---	1335	---	---	361	2580	93.9	640			1913
		---	---	---	---	---	1570	424	2577	94.6	640			1947
52	810	---	---	---	---	---	---	219	2578	91.1	600	46.1	0.584	1682
		900	---	---	---	---	---	242	2571	91.8	600			1718
		---	945	---	---	---	---	254	2568	92.1	600			1735
		---	---	1075	---	---	---	290	2574	92.9	600			1760
		---	---	---	1250	---	---	337	2574	93.6	600			1792
		---	---	---	---	---	1470	396	2575	94.4	600			1823
						1710	461	2576	94.9	600				1846

Nota (\*) - VENTILAZIONE SOLO L.O. / FAN ONLY SIDE COMMUTATOR

Nota (°) - Regolazione di campo / Field weakening

CEAR S.r.l. - Via Valchiampo,14 - 36050 MONTORSO (Vicenza) - Italy

Telefoni 0039 0444 685505 - 685062 - Fax 0039 0444 686190 - www.cearmotors.com - info@cearmotors.com



Potenza eccitazione  
Excitation power (w) 2800  
Cost. tempo eccitaz.  
Field time constant (ms) 490  
Massa del motore  
Mass of the motor (Kg) 1530  
Momento d'inerzia rotore  
Rotor inertia moment (Kgm2) 7.3

Tipo  
Size MGL C 280 L  
Ventilazione  
Ventilation IC 06

Avv.	Velocità nominale n/min a tensione nominale di armatura Rated speed (rev/min) at rated voltage							Potenza Power kW	Coppia vel.nomin. Torque at rated speed Nm	Rendimento Efficiency %	Circuito di armatura Armature circuit			Max giri Max. speed (°)
	400	440	460	520	600	700	810				Corrente Current Amp	Res. 115°C mOhm	Ind. mH	
53	760	---	---	---	---	---	---	207	2597	90.7	570	51.8	0.655	1900
		845	---	---	---	---	---	229	2590	91.4	570			1859
		---	885	---	---	---	---	240	2594	91.7	570			1770
		---	---	1010	---	---	---	274	2592	92.5	570			1919
		---	---	---	1175	---	---	319	2594	93.3	570			1997
		---	---	---	---	1380	---	375	2598	94.1	570			2346
		---	---	---	---	---	1610	437	2593	94.7	570			2415
		---	---	---	---	---	---	---	---	---	---			---
54	740	---	---	---	---	---	---	201	2590	90.4	555	54.8	0.694	1850
		820	---	---	---	---	---	223	2593	91.2	555			1804
		---	860	---	---	---	---	234	2594	91.5	555			1720
		---	---	980	---	---	---	266	2596	92.3	555			1862
		---	---	---	1140	---	---	310	2598	93.2	555			1939
		---	---	---	---	1340	---	365	2601	93.9	555			2278
		---	---	---	---	---	1565	425	2595	94.6	555			2348
		---	---	---	---	---	---	---	---	---	---			---
55	685	---	---	---	---	---	---	185	2581	89.9	515	63.3	0.81	1713
		760	---	---	---	---	---	205	2582	90.7	515			1672
		---	795	---	---	---	---	216	2589	91.1	515			1591
		---	---	910	---	---	---	246	2583	91.9	515			1729
		---	---	---	1060	---	---	287	2584	92.8	515			1802
		---	---	---	---	1245	---	338	2589	93.7	515			2117
		---	---	---	---	---	1450	393	2591	94.4	515			2175
		---	---	---	---	---	---	---	---	---	---			---
56	635	---	---	---	---	---	---	172	2579	89.4	480	72.3	0.931	1588
		705	---	---	---	---	---	191	2579	90.2	480			1552
		---	740	---	---	---	---	200	2579	90.6	480			1481
		---	---	845	---	---	---	228	2581	91.5	480			1606
		---	---	---	985	---	---	266	2582	92.5	480			1675
		---	---	---	---	1160	---	314	2582	93.4	480			1972
		---	---	---	---	---	1355	366	2577	94.1	480			2033
		---	---	---	---	---	---	---	---	---	---			---
57	595	---	---	---	---	---	---	161	2592	88.7	455	81.9	1.05	1488
		660	---	---	---	---	---	179	2596	89.6	455			1452
		---	690	---	---	---	---	188	2608	90.0	455			1380
		---	---	790	---	---	---	215	2603	91.0	455			1501
		---	---	---	920	---	---	251	2608	92.0	455			1564
		---	---	---	---	1085	---	296	2607	93.0	455			1845
		---	---	---	---	---	1270	346	2598	93.8	455			1905
		---	---	---	---	---	---	---	---	---	---			---
58	555	---	---	---	---	---	---	152	2609	88.2	430	92.1	1.19	1388
		615	---	---	---	---	---	169	2618	89.1	430			1353
		---	650	---	---	---	---	177	2601	89.6	430			1300
		---	---	740	---	---	---	203	2614	90.6	430			1406
		---	---	---	865	---	---	236	2609	91.7	430			1471
		---	---	---	---	1020	---	279	2611	92.7	430			1734
		---	---	---	---	---	1190	326	2613	93.5	430			1785
		---	---	---	---	---	---	---	---	---	---			---
59	520	---	---	---	---	---	---	142	2607	87.6	405	103.0	1.34	1300
		580	---	---	---	---	---	158	2600	88.6	405			1276
		---	610	---	---	---	---	166	2597	89.1	405			1220
		---	---	700	---	---	---	190	2591	90.2	405			1330
		---	---	---	815	---	---	222	2600	91.3	405			1386
		---	---	---	---	960	---	262	2605	92.3	405			1632
		---	---	---	---	---	1125	306	2596	93.2	405			1688
		---	---	---	---	---	---	---	---	---	---			---

Nota (\*) - VENTILAZIONE SOLO L.O. / FAN ONLY SIDE COMMUTATOR

Nota (°) - Regolazione di campo / Field weakening

CEAR S.r.l. - Via Valchiampo,14 - 36050 MONTORSO (Vicenza) - Italy

Telefoni 0039 0444 685505 - 685062 - Fax 0039 0444 686190 - www.cearmotors.com - info@cearmotors.com



Potenza eccitazione Excitation power	(w)	3000	Tipo Size Ventilazione Ventilation	MGL C 280 P  IC 06
Cost. tempo eccitaz. Field time constant	(ms)	510		
Massa del motore Mass of the motor	(Kg)	1830		
Momento d'inerzia rotore Rotor inertia moment	(Kgm2)	8.3		

Avv.	Velocità nominale n/min a tensione nominale di armatura Rated speed (rev/min) at rated voltage							Potenza Power kW	Coppia vel.nomin. Torque at rated speed Nm	Rendimento Efficiency %	Circuito di armatura Armature circuit			Max giri Max. speed (°)	*
	400	440	460	520	600	700	810				Corrente Current Amp	Res. 115°C mOhm	Ind. mH		
39	1650	---	---	---	---	---	---	536	3102	94.4	1420	10.0	0.122	2500	*
		1820	---	---	---	---	---	592	3106	94.8	1420			2500	*
		1905	---	---	---	---	---	620	3108	94.9	1420			2500	*
40	1500	---	---	---	---	---	---	489	3113	94.0	1300	12.0	0.146	2500	*
		1655	---	---	---	---	---	540	3116	94.4	1300			2500	*
		1735	---	---	---	---	---	566	3115	94.6	1300			2500	*
41	1375	---	---	---	---	---	---	448	3111	93.7	1195	14.2	0.174	2500	*
		1520	---	---	---	---	---	495	3110	94.1	1195			2500	*
		1590	---	---	---	---	---	519	3117	94.4	1195			2500	*
		1805	---	---	---	---	---	589	3116	94.8	1195			2500	*
42	1265	---	---	---	---	---	---	413	3117	93.4	1105	16.6	0.204	2500	*
		1400	---	---	---	---	---	456	3113	93.9	1105			2500	*
		1470	---	---	---	---	---	478	3107	94.1	1105			2500	*
		1670	---	---	---	---	---	544	3109	94.6	1105			2500	*
43	1175	---	---	---	---	---	---	383	3115	93.1	1030	19.1	0.235	2396	*
		1300	---	---	---	---	---	424	3115	93.6	1030			2437	*
		1360	---	---	---	---	---	444	3120	93.8	1030			2437	*
		1550	---	---	---	---	---	505	3113	94.4	1030			2480	*
		1800	---	---	---	---	---	587	3112	94.9	1030			2500	*
44	1095	---	---	---	---	---	---	358	3121	92.7	965	21.9	0.269	2269	*
		1210	---	---	---	---	---	396	3125	93.2	965			2291	*
		1270	---	---	---	---	---	415	3120	93.5	965			2306	*
		1445	---	---	---	---	---	472	3120	94.1	965			2345	*
		1680	---	---	---	---	---	548	3116	94.7	965			2387	*
45	1025	---	---	---	---	---	---	334	3116	92.4	905	24.8	0.307	2422	*
		1135	---	---	---	---	---	370	3114	93.0	905			2455	*
		1190	---	---	---	---	---	388	3114	93.2	905			2477	*
		1355	---	---	---	---	---	442	3112	93.8	905			2500	*
		1575	---	---	---	---	---	513	3110	94.5	905			2500	*
1845	---	---	---	---	---	602	3117	95.1	905	2500	*				

Nota (\*) - VENTILAZIONE SOLO L.O. / FAN ONLY SIDE COMMUTATOR

Nota (°) - Regolazione di campo / Field weakening

CEAR S.r.l. - Via Valchiampo,14 - 36050 MONTORSO (Vicenza) - Italy

Telefoni 0039 0444 685505 - 685062 - Fax 0039 0444 686190 - [www.cearmotors.com](http://www.cearmotors.com) - [info@cearmotors.com](mailto:info@cearmotors.com)



Potenza eccitazione Excitation power	(w)	3000	Tipo Size	MGL C 280 P
Cost. tempo eccitaz. Field time constant	(ms)	510		
Massa del motore Mass of the motor	(Kg)	1830	Ventilazione Ventilation	IC 06
Momento d'inerzia rotore Rotor inertia moment	(Kgm2)	8.3		

Avv.	Velocità nominale n/min a tensione nominale di armatura Rated speed (rev/min) at rated voltage							Potenza Power kW	Coppia vel.nomin. Torque at rated speed Nm	Rendimento Efficiency %	Circuito di armatura Armature circuit			Max giri Max. speed (°)			
	400	440	460	520	600	700	810				Corrente Current Amp	Res. 115°C mOhm	Ind. mH				
46	965	1065	---	---	---	---	---	315	3115	92.1	855	27.9	0.346	2174	*		
			---	---	---	---	---	---	349	3125	92.7			855		2198	
			---	---	---	---	---	---	---	365	3115			92.9		855	2217
			---	---	---	---	---	---	---	416	3116			93.6		855	2265
			---	---	---	---	---	---	---	483	3119			94.3		855	2296
			---	---	---	---	---	---	---	568	3125			94.9		855	2334
			---	---	---	---	---	---	---	---	---			---		---	---
47	910	1005	---	---	---	---	---	297	3118	91.7	810	31.1	0.387	2305	*		
			---	---	---	---	---	---	329	3125	92.3			810		2341	
			---	---	---	---	---	---	---	345	3123			92.6		810	2368
			---	---	---	---	---	---	---	393	3127			93.3		810	2402
			---	---	---	---	---	---	---	457	3128			94.0		810	2449
			---	---	---	---	---	---	---	537	3126			94.7		810	2500
			---	---	---	---	---	---	---	625	3123			95.2		810	2500
48	895	990	---	---	---	---	---	293	3128	91.6	800	32.0	0.397	2463	*		
			---	---	---	---	---	---	325	3132	92.2			800		2500	
			---	---	---	---	---	---	---	340	3126			92.5		800	2500
			---	---	---	---	---	---	---	388	3125			93.2		800	2500
			---	---	---	---	---	---	---	451	3132			94.0		800	2500
			---	---	---	---	---	---	---	530	3133			94.6		800	2500
			---	---	---	---	---	---	---	617	3132			95.2		800	2500
49	825	915	---	---	---	---	---	270	3121	91.1	740	37.3	0.466	2307	*		
			---	---	---	---	---	---	299	3119	91.8			740		2352	
			---	---	---	---	---	---	---	313	3118			92.1		740	2371
			---	---	---	---	---	---	---	357	3130			92.8		740	2410
			---	---	---	---	---	---	---	416	3125			93.6		740	2465
			---	---	---	---	---	---	---	489	3121			94.3		740	2500
			---	---	---	---	---	---	---	569	3122			94.9		740	2500
50	765	845	---	---	---	---	---	250	3121	90.6	690	43.0	0.54	2255	*		
			---	---	---	---	---	---	277	3133	91.3			690		2293	
			---	---	---	---	---	---	---	291	3139			91.6		690	2299
			---	---	---	---	---	---	---	332	3136			92.4		690	2346
			---	---	---	---	---	---	---	386	3125			93.3		690	2410
			---	---	---	---	---	---	---	454	3132			94.0		690	2466
			---	---	---	---	---	---	---	529	3128			94.7		690	2500
51	710	790	---	---	---	---	---	231	3103	90.1	640	49.2	0.625	2063	*		
			---	---	---	---	---	---	256	3095	90.9			640		2097	
			---	---	---	---	---	---	---	269	3110			91.2		640	2109
			---	---	---	---	---	---	---	307	3097			92.1		640	2155
			---	---	---	---	---	---	---	357	3099			93.0		640	2214
			---	---	---	---	---	---	---	420	3098			93.8		640	2258
			---	---	---	---	---	---	---	490	3106			94.4		640	2285
52	665	735	---	---	---	---	---	215	3090	89.7	600	55.7	0.713	1972	*		
			---	---	---	---	---	---	239	3103	90.5			600		2022	
			---	---	---	---	---	---	---	251	3089			90.8		600	2045
			---	---	---	---	---	---	---	286	3088			91.7		600	2086
			---	---	---	---	---	---	---	334	3092			92.7		600	2140
			---	---	---	---	---	---	---	393	3099			93.5		600	2172
			---	---	---	---	---	---	---	458	3101			94.2		600	2221

Nota (\*) - VENTILAZIONE SOLO L.O. / FAN ONLY SIDE COMMUTATOR

Nota (°) - Regolazione di campo / Field weakening



Potenza eccitazione Excitation power	(w)	3000	Tipo Size	MGL C 280 P
Cost. tempo eccitaz. Field time constant	(ms)	510		
Massa del motore Mass of the motor	(Kg)	1830	Ventilazione Ventilation	IC 06
Momento d'inerzia rotore Rotor inertia moment	(Kgm2)	8.3		

Avv.	Velocità nominale n/min a tensione nominale di armatura Rated speed (rev/min) at rated voltage							Potenza Power kW	Coppia vel.nomin. Torque at rated speed Nm	Rendimento Efficiency %	Circuito di armatura Armature circuit			Max giri Max. speed (°)
	400	440	460	520	600	700	810				Corrente Current Amp	Res. 115°C mOhm	Ind. mH	
53	620	---	---	---	---	---	---	203	3129	89.1	570	62.7	0.801	2097
		690	---	---	---	---	---	226	3122	90.0	570			2156
		725	---	---	---	---	---	237	3120	90.4	570			2170
		830	---	---	---	---	---	271	3113	91.3	570			2229
		965	---	---	---	---	---	316	3123	92.3	570			2290
		1140	---	---	---	---	---	372	3114	93.2	570			2354
		1325	---	---	---	---	---	434	3125	93.9	570			2399
		---	---	---	---	---	---	---	---	---	---			---
54	605	---	---	---	---	---	---	197	3113	88.8	555	66.3	0.848	2212
		670	---	---	---	---	---	219	3125	89.7	555			2257
		705	---	---	---	---	---	230	3116	90.1	555			2299
		805	---	---	---	---	---	263	3119	91.1	555			2348
		935	---	---	---	---	---	307	3132	92.1	555			2404
		1105	---	---	---	---	---	361	3123	93.0	555			2482
		1290	---	---	---	---	---	422	3121	93.8	555			2500
		---	---	---	---	---	---	---	---	---	---			---
55	555	---	---	---	---	---	---	182	3125	88.2	515	76.5	0.988	2100
		620	---	---	---	---	---	202	3111	89.2	515			2180
		650	---	---	---	---	---	212	3114	89.6	515			2207
		745	---	---	---	---	---	243	3110	90.6	515			2262
		870	---	---	---	---	---	283	3109	91.7	515			2344
		1025	---	---	---	---	---	334	3112	92.7	515			2404
		1195	---	---	---	---	---	390	3115	93.5	515			2454
		---	---	---	---	---	---	---	---	---	---			---
56	515	---	---	---	---	---	---	168	3117	87.6	480	87.4	1.14	1948
		575	---	---	---	---	---	187	3106	88.6	480			2029
		605	---	---	---	---	---	196	3103	89.0	480			2050
		690	---	---	---	---	---	225	3112	90.1	480			2096
		810	---	---	---	---	---	263	3098	91.3	480			2161
		955	---	---	---	---	---	310	3101	92.3	480			2228
		1115	---	---	---	---	---	362	3103	93.2	480			2285
		---	---	---	---	---	---	---	---	---	---			---
57	480	---	---	---	---	---	---	158	3142	86.8	455	99.1	1.29	1833
		535	---	---	---	---	---	176	3139	87.9	455			2022
		565	---	---	---	---	---	185	3125	88.3	455			2155
		645	---	---	---	---	---	212	3136	89.5	455			2232
		755	---	---	---	---	---	248	3131	90.7	455			2306
		890	---	---	---	---	---	293	3139	91.9	455			2383
		1045	---	---	---	---	---	342	3125	92.8	455			2461
		---	---	---	---	---	---	---	---	---	---			---
58	450	---	---	---	---	---	---	148	3142	86.1	430	111.4	1.46	1709
		500	---	---	---	---	---	165	3152	87.3	430			1902
		530	---	---	---	---	---	173	3126	87.8	430			2000
		605	---	---	---	---	---	199	3138	89.0	430			2296
		710	---	---	---	---	---	233	3132	90.3	430			2500
		840	---	---	---	---	---	275	3130	91.5	430			2500
		980	---	---	---	---	---	322	3137	92.5	430			2500
		---	---	---	---	---	---	---	---	---	---			---
59	425	---	---	---	---	---	---	138	3110	85.4	405	124.5	1.65	1614
		470	---	---	---	---	---	154	3137	86.6	405			1783
		495	---	---	---	---	---	162	3133	87.2	405			1886
		570	---	---	---	---	---	186	3125	88.5	405			2163
		665	---	---	---	---	---	218	3135	89.8	405			2500
		790	---	---	---	---	---	258	3122	91.1	405			2500
		925	---	---	---	---	---	302	3120	92.1	405			2500
		---	---	---	---	---	---	---	---	---	---			---

Nota (\*) - VENTILAZIONE SOLO L.O. / FAN ONLY SIDE COMMUTATOR

Nota (°) - Regolazione di campo / Field weakening



Potenza eccitazione  
Excitation power (w) 3500  
Cost. tempo eccitaz.  
Field time constant (ms) 530  
Massa del motore  
Mass of the motor (Kg) 1880  
Momento d'inerzia rotore  
Rotor inertia moment (Kgm2) 8.8

Tipo  
Size MGL C 280 X  
Ventilazione  
Ventilation IC 06

Avv.	Velocità nominale n/min a tensione nominale di armatura Rated speed (rev/min) at rated voltage							Potenza Power kW	Coppia vel.nomin. Torque at rated speed Nm	Rendimento Efficiency %	Circuito di armatura Armature circuit			Max giri Max. speed (°)	*
	400	440	460	520	600	700	810				Corrente Current Amp	Res. 115°C mOhm	Ind. mH		
39	1490	---	---	---	---	---	---	534	3424	94.1	1420	11.0	0.135	2500	*
		1645	---	---	---	---	---	590	3427	94.5	1420			2500	*
		---	1725	---	---	---	---	618	3423	94.7	1420			2500	*
40	1355	---	---	---	---	---	---	487	3434	93.7	1300	13.2	0.162	2500	*
		1500	---	---	---	---	---	539	3429	94.1	1300			2500	*
		---	1570	---	---	---	---	564	3432	94.3	1300			2500	*
41	1240	---	---	---	---	---	---	446	3436	93.3	1195	15.6	0.192	2407	*
		1370	---	---	---	---	---	493	3438	93.8	1195			2442	*
		---	1440	---	---	---	---	517	3428	94.0	1195			2460	*
		---	---	1635	---	---	---	588	3433	94.6	1195			2492	*
42	1145	---	---	---	---	---	---	411	3427	93.0	1105	18.1723	0.225	2291	*
		1265	---	---	---	---	---	454	3431	93.5	1105			2332	*
		---	1325	---	---	---	---	476	3433	93.7	1105			2343	*
		---	---	1510	---	---	---	542	3426	94.3	1105			2380	*
43	1060	---	---	---	---	---	---	381	3436	92.6	1030	21.0	0.261	2161	*
		1175	---	---	---	---	---	422	3430	93.1	1030			2202	*
		---	1230	---	---	---	---	442	3434	93.4	1030			2204	*
		---	---	1400	---	---	---	503	3433	94.0	1030			2240	*
		---	---	---	1625	---	---	584	3435	94.6	1030			2278	*
44	990	---	---	---	---	---	---	356	3434	92.2	965	24.0	0.298	2051	
		1095	---	---	---	---	---	394	3437	92.8	965			2073	
		---	1150	---	---	---	---	413	3430	93.0	965			2088	
		---	---	1305	---	---	---	470	3441	93.7	965			2118	
		---	---	---	1520	---	---	546	3432	94.4	965			2159	
45	925	---	---	---	---	---	---	332	3432	91.9	905	27.1	0.34	2186	
		1025	---	---	---	---	---	368	3430	92.5	905			2217	
		---	1075	---	---	---	---	386	3430	92.7	905			2238	
		---	---	1225	---	---	---	440	3427	93.4	905			2280	*
		---	---	---	1420	---	---	511	3436	94.1	905			2320	*
		---	---	---	---	1670	---	600	3432	94.8	905			2358	*

Nota (\*) - VENTILAZIONE SOLO L.O. / FAN ONLY SIDE COMMUTATOR

Nota (°) - Regolazione di campo / Field weakening

CEAR S.r.l. - Via Valchiampo,14 - 36050 MONTORSO (Vicenza) - Italy

Telefoni 0039 0444 685505 - 685062 - Fax 0039 0444 686190 - www.cearmotors.com - info@cearmotors.com





Potenza eccitazione  
Excitation power (w) 3500  
Cost. tempo eccitaz.  
Field time constant (ms) 530  
Massa del motore  
Mass of the motor (Kg) 1880  
Momento d'inerzia rotore  
Rotor inertia moment (Kgm2) 8.8

Tipo  
Size MGL C 280 X  
Ventilazione  
Ventilation IC 06

Avv.	Velocità nominale n/min a tensione nominale di armatura Rated speed (rev/min) at rated voltage							Potenza Power kW	Coppia vel.nomin. Torque at rated speed Nm	Rendimento Efficiency %	Circuito di armatura Armature circuit			Max giri Max. speed (°)	
	400	440	460	520	600	700	810				Corrente Current Amp	Res. 115°C mOhm	Ind. mH		
46	870	---	---	---	---	---	---	313	3433	91.5	855	30.5	0.383	1960	*
		965	---	---	---	---	---	346	3429	92.1	855			1991	
		1010	---	---	---	---	---	363	3437	92.4	855			1999	
		1150	---	---	---	---	---	414	3437	93.1	855			2043	
		1335	---	---	---	---	---	481	3443	93.9	855			2071	
		1570	---	---	---	---	---	566	3441	94.5	855			2112	
47	820	---	---	---	---	---	---	295	3437	91.1	810	34.1	0.429	2077	
		910	---	---	---	---	---	327	3433	91.8	810			2118	
		950	---	---	---	---	---	343	3449	92.1	810			2132	
		1085	---	---	---	---	---	391	3443	92.8	810			2170	
		1260	---	---	---	---	---	455	3448	93.6	810			2212	
		1485	---	---	---	---	---	535	3440	94.3	810			2265	
48	805	---	---	---	---	---	---	291	3454	91.0	800	35.1	0.44	2216	
		895	---	---	---	---	---	323	3444	91.7	800			2263	
		940	---	---	---	---	---	339	3439	92.0	800			2292	
		1070	---	---	---	---	---	386	3444	92.8	800			2325	
		1245	---	---	---	---	---	449	3444	93.5	800			2386	
		1465	---	---	---	---	---	528	3441	94.3	800			2427	
49	745	---	---	---	---	---	---	268	3432	90.5	740	40.9	0.517	2083	
		825	---	---	---	---	---	297	3437	91.2	740			2120	
		865	---	---	---	---	---	312	3439	91.5	740			2136	
		985	---	---	---	---	---	355	3445	92.3	740			2178	
		1145	---	---	---	---	---	414	3451	93.2	740			2222	
		1350	---	---	---	---	---	487	3444	94.0	740			2284	
50	685	---	---	---	---	---	---	248	3460	89.9	690	47.2	0.599	2019	*
		760	---	---	---	---	---	275	3461	90.7	690			2062	
		800	---	---	---	---	---	289	3449	91.1	690			2079	
		915	---	---	---	---	---	330	3443	91.9	690			2125	
		1065	---	---	---	---	---	384	3446	92.8	690			2175	
		1250	---	---	---	---	---	452	3457	93.7	690			2225	
51	640	---	---	---	---	---	---	229	3417	89.5	640	53.9	0.699	1859	*
		710	---	---	---	---	---	254	3416	90.2	640			1884	
		745	---	---	---	---	---	267	3422	90.7	640			1904	
		850	---	---	---	---	---	305	3427	91.6	640			1938	
		990	---	---	---	---	---	355	3424	92.4	640			1992	
		1170	---	---	---	---	---	418	3412	93.3	640			2040	
52	595	---	---	---	---	---	---	213	3422	88.9	600	61.1	0.792	1765	
		665	---	---	---	---	---	237	3402	89.7	600			1829	
		695	---	---	---	---	---	249	3417	90.1	600			1834	
		795	---	---	---	---	---	284	3414	91.1	600			1874	
		930	---	---	---	---	---	332	3404	92.1	600			1932	
		1095	---	---	---	---	---	391	3407	93.0	600			1966	
							1275	456	3414	93.8	600			2009	

Nota (\*) - VENTILAZIONE SOLO L.O. / FAN ONLY SIDE COMMUTATOR

Nota (°) - Regolazione di campo / Field weakening

CEAR S.r.l. - Via Valchiampo,14 - 36050 MONTORSO (Vicenza) - Italy

Telefoni 0039 0444 685505 - 685062 - Fax 0039 0444 686190 - www.cearmotors.com - info@cearmotors.com



Potenza eccitazione  
Excitation power (w) 3500  
Cost. tempo eccitaz.  
Field time constant (ms) 530  
Massa del motore  
Mass of the motor (Kg) 1880  
Momento d'inerzia rotore  
Rotor inertia moment (Kgm2) 8.8

Tipo  
Size MGL C 280 X  
Ventilazione  
Ventilation IC 06

Avv.	Velocità nominale n/min a tensione nominale di armatura Rated speed (rev/min) at rated voltage							Potenza Power kW	Coppia vel.nomin. Torque at rated speed Nm	Rendimento Efficiency %	Circuito di armatura Armature circuit			Max giri Max. speed (°)
	400	440	460	520	600	700	810				Corrente Current Amp	Res. 115°C mOhm	Ind. mH	
53	560	---	---	---	---	---	---	201	3430	88.2	570	68.7	0.890	1894
		620	---	---	---	---	---	224	3444	89.2	570			1938
		---	655	---	---	---	---	235	3424	89.6	570			1961
		---	---	745	---	---	---	269	3443	90.6	570			2001
		---	---	---	870	---	---	314	3442	91.7	570			2065
		---	---	---	---	1025	---	370	3445	92.7	570			2117
		---	---	---	---	---	1200	432	3434	93.5	570			2172
		---	---	---	---	---	---	---	---	---	---			---
54	540	---	---	---	---	---	---	195	3453	87.9	555	72.7	0.943	1974
		600	---	---	---	---	---	217	3456	88.9	555			2022
		---	635	---	---	---	---	228	3430	89.3	555			2071
		---	---	725	---	---	---	261	3437	90.4	555			2115
		---	---	---	845	---	---	305	3443	91.5	555			2173
		---	---	---	---	995	---	360	3450	92.5	555			2235
		---	---	---	---	---	1165	420	3441	93.4	555			2288
		---	---	---	---	---	---	---	---	---	---			---
55	500	---	---	---	---	---	---	180	3429	87.2	515	83.9	1.10	1893
		555	---	---	---	---	---	200	3441	88.3	515			1951
		---	585	---	---	---	---	210	3430	88.7	515			1985
		---	---	670	---	---	---	241	3430	89.9	515			2034
		---	---	---	785	---	---	281	3421	91.0	515			2115
		---	---	---	---	925	---	332	3428	92.1	515			2169
		---	---	---	---	---	1080	388	3430	93.0	515			2217
		---	---	---	---	---	---	---	---	---	---			---
56	465	---	---	---	---	---	---	166	3411	86.5	480	95.8	1.27	1759
		515	---	---	---	---	---	185	3431	87.6	480			1817
		---	545	---	---	---	---	194	3408	88.1	480			1847
		---	---	625	---	---	---	223	3406	89.3	480			1898
		---	---	---	730	---	---	261	3411	90.6	480			1947
		---	---	---	---	860	---	308	3421	91.7	480			2007
		---	---	---	---	---	1005	360	3422	92.7	480			2061
		---	---	---	---	---	---	---	---	---	---			---
57	430	---	---	---	---	---	---	156	3464	85.7	455	108.6	1.44	1642
		480	---	---	---	---	---	174	3460	86.9	455			1815
		---	505	---	---	---	---	183	3459	87.4	455			1926
		---	---	580	---	---	---	210	3455	88.7	455			2007
		---	---	---	680	---	---	246	3449	90.0	455			2076
		---	---	---	---	805	---	291	3449	91.2	455			2154
		---	---	---	---	---	940	340	3454	92.2	455			2214
		---	---	---	---	---	---	---	---	---	---			---
58	405	---	---	---	---	---	---	146	3443	84.9	430	122.1	1.63	1538
		450	---	---	---	---	---	163	3455	86.2	430			1713
		---	475	---	---	---	---	171	3447	86.7	430			1793
		---	---	545	---	---	---	197	3450	88.1	430			2067
		---	---	---	640	---	---	231	3444	89.5	430			2334
		---	---	---	---	755	---	273	3456	90.8	430			2409
		---	---	---	---	---	885	320	3451	91.9	430			2477
		---	---	---	---	---	---	---	---	---	---			---
59	380	---	---	---	---	---	---	136	3430	84.2	405	136.5	1.84	1443
		425	---	---	---	---	---	152	3426	85.5	405			1612
		---	445	---	---	---	---	160	3442	86.1	405			1696
		---	---	510	---	---	---	184	3453	87.6	405			1937
		---	---	---	600	---	---	216	3443	89.0	405			2281
		---	---	---	---	710	---	256	3448	90.4	405			2396
		---	---	---	---	---	835	300	3434	91.5	405			2470
		---	---	---	---	---	---	---	---	---	---			---

Nota (\*) - VENTILAZIONE SOLO L.O. / FAN ONLY SIDE COMMUTATOR

Nota (°) - Regolazione di campo / Field weakening

CEAR S.r.l. - Via Valchiampo,14 - 36050 MONTORSO (Vicenza) - Italy

Telefoni 0039 0444 685505 - 685062 - Fax 0039 0444 686190 - www.cearmotors.com - info@cearmotors.com



**MOTORI C.C. SERIE MGLC - D.C. MOTORS SERIES MGLC**

Forma costr. IM B3 e derivate - Mounting IM B3 and derived

Protezione IP23S - Protection IP23S

Ventilazione IC06 - Cooling IC06

**MGLC 250 - 280**

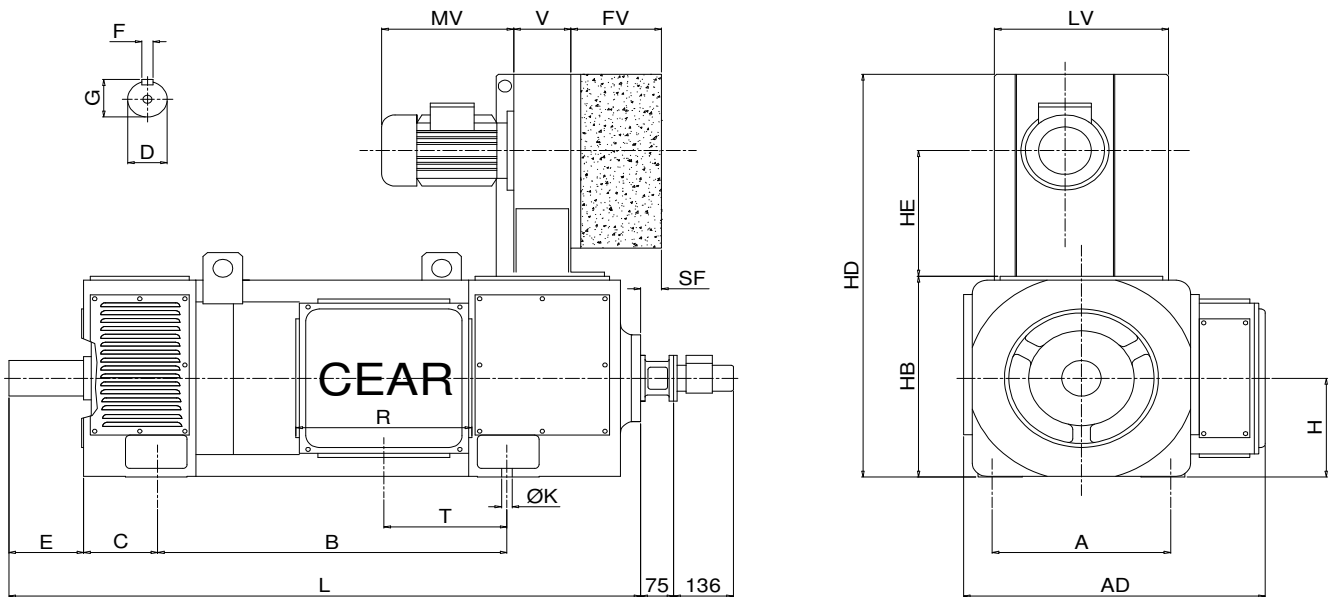

TYPE	SIZE	PIAZZAMENTO					INGOMBRO				ELETTOVENTILATORE					
		A	B	C	H	K	HD	HB	L	AD	FV	MV	V	SF	LV	HE
250	K	406	624	168	250	24	1119	508	1266	686	206	300	130	48	396	318
	S		674						1316							
	M		724						1366							
	L		784						1426							
	P		854						1496							
	X		894						1536							
280	S	457	700	190	280	27	1342	557	1431	811	345	332	235	224	690	470
	M		760						1491							
	L		830						1561							
	P		920						1651							
	X		970						1701							

TYPE	ALBERO				MORSETTIERA	
	E	D	F	G	R	T
250	170	95	25	100	400	280
280	210	110	28	116	420	305



Potenza eccitazione Excitation power	(w)	2900	Tipo Size Ventilazione Ventilation	MGL C 315 K  IC 06
Cost. tempo eccitaz. Field time constant	(ms)	500		
Massa del motore Mass of the motor	(Kg)	1820		
Momento d'inerzia rotore Rotor inertia moment	(Kgm2)	7.50		

Avv.	Velocità nominale n/min a tensione nominale di armatura Rated speed (rev/min) at rated voltage							Potenza Power kW	Coppia vel.nomin. Torque at rated speed Nm	Rendimento Efficiency %	Circuito di armatura Armature circuit			Max giri Max. speed (°)	*
	400	440	460	520	600	700	810				Corrente Current Amp	Res. 115°C mOhm	Ind. mH		
40	2370	---	---	---	---	---	---	555	2236	94.9	1462	7.29	0.082	2500	*
41	2170	---	---	---	---	---	---	545	2398	94.6	1440	8.35	0.109	2500	*
		2400	---	---	---	---	---	602	2395	95.0	1440			2500	*
42	2000	---	---	---	---	---	---	493	2354	94.1	1310	11.1	0.101	2500	*
		2205	---	---	---	---	---	537	2326	94.4	1293			2500	*
			2310	---	---	---	---	543	2245	94.7	1246			2500	*
43	1860	---	---	---	---	---	---	461	2367	94.0	1226	12.2	0.124	2500	*
		2055	---	---	---	---	---	509	2365	94.4	1226			2500	*
			2150	---	---	---	---	533	2367	94.5	1226			2500	*
				2440	---	---	---	586	2293	94.9	1187			2500	*
44	1735	---	---	---	---	---	---	430	2367	93.9	1145	13.6	0.155	2500	*
		1915	---	---	---	---	---	475	2369	94.3	1145			2500	*
			2010	---	---	---	---	497	2361	94.4	1145			2500	*
				2280	---	---	---	565	2366	94.9	1145			2500	*
45	1630	---	---	---	---	---	---	393	2302	93.6	1050	15.5	0.186	2500	*
		1800	---	---	---	---	---	434	2302	93.9	1050			2500	*
			1885	---	---	---	---	455	2305	94.2	1050			2500	*
				2140	---	---	---	517	2307	94.7	1050			2500	*
					2480	---	---	579	2229	95.2	1014			2500	*
46	1535	---	---	---	---	---	---	376	2339	93.6	1004	16.7	0.230	2500	*
		1695	---	---	---	---	---	415	2338	93.9	1004			2500	*
			1775	---	---	---	---	435	2340	94.2	1004			2500	*
				2015	---	---	---	494	2341	94.6	1004			2500	*
					2335	---	---	573	2343	95.1	1004			2500	*

Nota (\*) - VENTILAZIONE SOLO L.O. / FAN ONLY SIDE COMMUTATOR

Nota (°) - Regolazione di campo / Field weakening



Potenza eccitazione Excitation power (w) 2900	Tipo Size MGL C 315 K
Cost. tempo eccitaz. Field time constant (ms) 500	Ventilazione Ventilation IC 06
Massa del motore Mass of the motor (Kg) 1820	
Momento d'inerzia rotore Rotor inertia moment (Kgm2) 7.50	

Avv.	Velocità nominale n/min a tensione nominale di armatura Rated speed (rev/min) at rated voltage							Potenza Power kW	Coppia vel.nomin. Torque at rated speed Nm	Rendimento Efficiency %	Circuito di armatura Armature circuit			Max giri Max. speed (°)	*
	400	440	460	520	600	700	810				Corrente Current Amp	Res. 115°C mOhm	Ind. mH		
47	1440	---	---	---	---	---	---	328	2175	92.8	884	22.5	0.206	2500	*
		1590	---	---	---	---	---	362	2174	93.1	884			2500	*
		---	1665	---	---	---	---	380	2179	93.4	884			2500	*
		---	---	1895	---	---	---	432	2177	94.0	884			2500	*
		---	---	---	2200	---	---	501	2175	94.5	884			2500	*
48	1420	---	---	---	---	---	---	364	2448	92.9	980	19.8	0.217	2500	*
		1570	---	---	---	---	---	403	2451	93.5	980			2500	*
		---	1645	---	---	---	---	422	2450	93.6	980			2500	*
		---	---	1870	---	---	---	480	2451	94.2	980			2500	*
		---	---	---	2170	---	---	557	2451	94.7	980			2500	*
49	1310	---	---	---	---	---	---	334	2435	92.8	900	22.5	0.285	2500	*
		1450	---	---	---	---	---	369	2430	93.2	900			2500	*
		---	1520	---	---	---	---	387	2431	93.5	900			2500	*
		---	---	1730	---	---	---	440	2429	94.0	900			2500	*
		---	---	---	2005	---	---	511	2434	94.6	900			2500	*
---	---	---	---	---	2355	---	598	2425	95.1	898	2500	*			
50	1215	---	---	---	---	---	---	300	2358	92.0	815	28.1	0.288	2500	*
		1345	---	---	---	---	---	332	2357	92.6	815			2500	*
		---	1405	---	---	---	---	348	2365	92.8	815			2500	*
		---	---	1600	---	---	---	396	2363	93.4	815			2500	*
		---	---	---	1860	---	---	460	2362	94.1	815			2500	*
---	---	---	---	---	2185	---	540	2360	94.7	815	2500	*			
51	1130	---	---	---	---	---	---	290	2451	91.8	790	30.1	0.358	2491	*
		1255	---	---	---	---	---	321	2442	92.3	790			2500	*
		---	1315	---	---	---	---	337	2447	92.7	790			2500	*
		---	---	1495	---	---	---	384	2453	93.5	790			2500	*
		---	---	---	1740	---	---	446	2448	94.1	790			2500	*
---	---	---	---	---	2040	---	523	2448	94.6	790	2500	*			
---	---	---	---	---	---	2375	609	2449	95.2	790	2500	*			
52	1060	---	---	---	---	---	---	266	2396	91.7	725	33.8	0.427	2437	*
		1175	---	---	---	---	---	294	2389	92.2	725			2476	*
		---	1230	---	---	---	---	309	2399	92.7	725			2493	*
		---	---	1405	---	---	---	351	2386	93.1	725			2500	*
		---	---	---	1630	---	---	408	2390	93.8	725			2500	*
---	---	---	---	---	1915	---	480	2394	94.6	725	2500	*			
---	---	---	---	---	---	2230	558	2389	95.0	725	2500	*			
53	1000	---	---	---	---	---	---	243	2320	91.5	664	38.5	0.511	2500	*
		1105	---	---	---	---	---	269	2325	92.1	664			2500	*
		---	1160	---	---	---	---	282	2321	92.3	664			2500	*
		---	---	1320	---	---	---	321	2322	93.0	664			2500	*
		---	---	---	1535	---	---	373	2320	93.6	664			2500	*
---	---	---	---	---	1805	---	438	2317	94.2	664	2500	*			
---	---	---	---	---	---	2095	510	2325	94.8	664	2500	*			

Nota (\*) - VENTILAZIONE SOLO L.O. / FAN ONLY SIDE COMMUTATOR

Nota (°) - Regolazione di campo / Field weakening



Potenza eccitazione Excitation power (w) 2900	
Cost. tempo eccitaz. Field time constant (ms) 500	
Massa del motore Mass of the motor (Kg) 1820	
Momento d'inerzia rotore Rotor inertia moment (Kgm2) 7.50	
Tipo Size MGL C 315 K	
Ventilazione Ventilation IC 06	

Avv.	Velocità nominale n/min a tensione nominale di armatura Rated speed (rev/min) at rated voltage							Potenza Power kW	Coppia vel.nomin. Torque at rated speed Nm	Rendimento Efficiency %	Circuito di armatura Armature circuit			Max giri Max. speed (°)
	400	440	460	520	600	700	810				Corrente Current Amp	Res. 115°C mOhm	Ind. mH	
54	965	---	---	---	---	---	---	239	2365	90.8	658	42.8	0.470	2500
		1070	---	---	---	---	---	265	2365	91.5	658			2500
		---	1120	---	---	---	---	278	2370	91.8	658			2500
		---	---	1275	---	---	---	316	2367	92.4	658			2500
		---	---	---	1485	---	---	368	2366	93.2	658			2500
		---	---	---	---	1745	---	433	2370	94.0	658			2500
		---	---	---	---	---	2030	504	2371	94.6	658			2500
		---	---	---	---	---	---	---	---	---	---			---
55	890	---	---	---	---	---	---	216	2318	90.0	600	51.1	0.514	2500
		990	---	---	---	---	---	240	2315	90.9	600			2500
		---	1035	---	---	---	---	252	2325	91.3	600			2500
		---	---	1180	---	---	---	287	2323	92.0	600			2500
		---	---	---	1375	---	---	334	2320	92.8	600			2500
		---	---	---	---	1620	---	393	2317	93.6	600			2500
		---	---	---	---	---	1885	458	2320	94.2	600			2500
		---	---	---	---	---	---	---	---	---	---			---
56	830	---	---	---	---	---	---	206	2370	90.0	572	55.0	0.644	2424
		925	---	---	---	---	---	228	2354	90.6	572			2475
		---	970	---	---	---	---	240	2363	91.2	572			2497
		---	---	1105	---	---	---	273	2359	91.8	572			2500
		---	---	---	1285	---	---	318	2363	92.7	572			2500
		---	---	---	---	1515	---	374	2357	93.4	572			2500
		---	---	---	---	---	1765	436	2359	94.1	572			2500
		---	---	---	---	---	---	---	---	---	---			---
57	780	---	---	---	---	---	---	188	2302	89.5	525	61.9	0.742	2500
		865	---	---	---	---	---	209	2307	90.5	525			2500
		---	905	---	---	---	---	219	2311	90.7	525			2500
		---	---	1035	---	---	---	250	2307	91.6	525			2500
		---	---	---	1205	---	---	291	2306	92.4	525			2500
		---	---	---	---	1420	---	343	2307	93.3	525			2500
		---	---	---	---	---	1655	400	2308	94.1	525			2500
		---	---	---	---	---	---	---	---	---	---			---
58	725	---	---	---	---	---	---	169	2226	88.0	480	80.2	0.737	2387
		805	---	---	---	---	---	188	2230	89.0	480			2445
		---	845	---	---	---	---	198	2238	89.7	480			2470
		---	---	965	---	---	---	226	2236	90.5	480			2500
		---	---	---	1125	---	---	264	2241	91.7	480			2500
		---	---	---	---	1325	---	311	2241	92.6	480			2500
		---	---	---	---	---	1545	363	2244	93.4	480			2500
		---	---	---	---	---	---	---	---	---	---			---
59	680	---	---	---	---	---	---	161	2261	87.5	460	88.3	0.859	2349
		755	---	---	---	---	---	179	2264	88.4	460			2409
		---	795	---	---	---	---	188	2258	88.8	460			2436
		---	---	910	---	---	---	216	2267	90.3	460			2500
		---	---	---	1060	---	---	252	2270	91.3	460			2500
		---	---	---	---	1250	---	297	2269	92.2	460			2500
		---	---	---	---	---	1460	347	2270	93.1	460			2500
		---	---	---	---	---	---	---	---	---	---			---
60	635	---	---	---	---	---	---	167	2511	87.9	475	83.1	1.04	1670
		705	---	---	---	---	---	186	2519	89.0	475			1697
		---	740	---	---	---	---	195	2516	89.2	475			1708
		---	---	845	---	---	---	223	2520	90.3	475			1738
		---	---	---	990	---	---	261	2518	91.6	475			1769
		---	---	---	---	1165	---	307	2516	92.3	475			1797
		---	---	---	---	---	1360	359	2521	93.3	475			1821
		---	---	---	---	---	---	---	---	---	---			---

Nota (\*) - VENTILAZIONE SOLO L.O. / FAN ONLY SIDE COMMUTATOR

Nota (°) - Regolazione di campo / Field weakening



Potenza eccitazione Excitation power (w)	2900	Tipo Size	MGL C 315 K
Cost. tempo eccitaz. Field time constant (ms)	500	Ventilazione Ventilation	IC 06
Massa del motore Mass of the motor (Kg)	1820		
Momento d'inerzia rotore Rotor inertia moment (Kgm2)	7.50		

Avv.	Velocità nominale n/min a tensione nominale di armatura Rated speed (rev/min) at rated voltage							Potenza Power kW	Coppia vel. nomin. Torque at rated speed Nm	Rendimento Efficiency %	Circuito di armatura Armature circuit			Max giri Max. speed (°)
	400	440	460	520	600	700	810				Corrente Current Amp	Res. 115°C mOhm	Ind. mH	
61	585	---	---	---	---	---	---	144	2351	87.4	412	102	1.37	1630
		650	---	---	---	---	---	160	2351	88.3				1658
		685	---	---	---	---	---	168	2342	88.6				1670
		785	---	---	---	---	---	192	2336	89.6				1701
		915	---	---	---	---	---	225	2348	91.0				1733
		1080	---	---	---	---	---	265	2343	91.9				1763
		1260	---	---	---	---	---	310	2349	92.9				1787
62	540	---	---	---	---	---	---	138	2440	86.3	400	116	1.34	1506
		600	---	---	---	---	---	154	2451	87.5				1532
		635	---	---	---	---	---	162	2436	88.0				1543
		725	---	---	---	---	---	185	2437	88.9				1571
		850	---	---	---	---	---	217	2438	90.4				1601
		1000	---	---	---	---	---	256	2445	91.4				1629
		1170	---	---	---	---	---	299	2440	92.3				1652
63	505	---	---	---	---	---	---	125	2364	85.9	364	132	1.58	1591
		565	---	---	---	---	---	139	2349	86.8				1621
		590	---	---	---	---	---	147	2379	87.8				1635
		680	---	---	---	---	---	168	2359	88.8				1670
		795	---	---	---	---	---	197	2366	90.2				1706
		940	---	---	---	---	---	232	2357	91.1				1739
		1095	---	---	---	---	---	272	2372	92.3				1767
64	470	---	---	---	---	---	---	114	2316	85.3	334	151	1.95	1558
		525	---	---	---	---	---	127	2310	86.4				1590
		555	---	---	---	---	---	134	2306	87.2				1604
		635	---	---	---	---	---	153	2301	88.1				1640
		745	---	---	---	---	---	180	2307	89.8				1677
		880	---	---	---	---	---	212	2301	90.7				1712
		1030	---	---	---	---	---	248	2299	91.7				1741
65	445	---	---	---	---	---	---	104	2232	84.4	308	171	2.34	1525
		495	---	---	---	---	---	116	2238	85.6				1558
		520	---	---	---	---	---	123	2259	86.8				1572
		600	---	---	---	---	---	141	2244	88.0				1609
		700	---	---	---	---	---	165	2251	89.3				1647
		830	---	---	---	---	---	195	2244	90.4				1683
		970	---	---	---	---	---	228	2245	91.4				1713

Nota (\*) - VENTILAZIONE SOLO L.O. / FAN ONLY SIDE COMMUTATOR

Nota (°) - Regolazione di campo / Field weakening





Potenza eccitazione Excitation power	(w)	3500	Tipo Size Ventilazione Ventilation	MGL C 315 S  IC 06
Cost. tempo eccitaz. Field time constant	(ms)	590		
Massa del motore Mass of the motor	(Kg)	1970		
Momento d'inerzia rotore Rotor inertia moment	(Kgm2)	8.50		

Avv.	Velocità nominale n/min a tensione nominale di armatura Rated speed (rev/min) at rated voltage							Potenza Power kW	Coppia vel.nomin. Torque at rated speed Nm	Rendimento Efficiency %	Circuito di armatura Armature circuit			Max giri Max. speed (°)	*
	400	440	460	520	600	700	810				Corrente Current Amp	Res. 115°C mOhm	Ind. mH		
40	1960	---	---	---	---	---	---	569	2772	94.8	1500	7.93	0.097	2500	*
		2165	---	---	---	---	---	628	2770	95.2	1500			2500	*
		2265	---	---	---	---	---	658	2774	95.4	1500			2500	*
41	1800	---	---	---	---	---	---	545	2891	94.6	1440	9.09	0.128	2500	*
		1985	---	---	---	---	---	602	2896	95.0	1440			2500	*
		2080	---	---	---	---	---	630	2892	95.1	1440			2500	*
		2360	---	---	---	---	---	715	2893	95.5	1440			2500	*
42	1655	---	---	---	---	---	---	492	2839	93.9	1310	12.1	0.118	2500	*
		1830	---	---	---	---	---	544	2839	94.4	1310			2500	*
		1915	---	---	---	---	---	570	2842	94.6	1310			2500	*
		2175	---	---	---	---	---	646	2836	95.0	1308			2500	*
43	1540	---	---	---	---	---	---	460	2852	93.8	1226	13.3	0.146	2500	*
		1700	---	---	---	---	---	509	2859	94.4	1226			2500	*
		1780	---	---	---	---	---	533	2859	94.5	1226			2500	*
		2025	---	---	---	---	---	605	2853	94.9	1226			2500	*
		2345	---	---	---	---	---	702	2859	95.4	1226			2500	*
44	1435	---	---	---	---	---	---	429	2855	93.7	1145	14.9	0.182	2419	*
		1590	---	---	---	---	---	474	2847	94.1	1145			2447	*
		1665	---	---	---	---	---	497	2850	94.4	1145			2459	*
		1890	---	---	---	---	---	564	2850	94.7	1145			2491	*
		2190	---	---	---	---	---	654	2852	95.2	1145			2500	*
45	1345	---	---	---	---	---	---	393	2790	93.6	1050	16.9	0.218	2500	*
		1490	---	---	---	---	---	434	2781	93.9	1050			2500	*
		1560	---	---	---	---	---	455	2785	94.2	1050			2500	*
		1770	---	---	---	---	---	517	2789	94.7	1050			2500	*
		2055	---	---	---	---	---	599	2783	95.1	1050			2500	*
		2410	---	---	---	---	---	697	2762	95.6	1041			2500	*
46	1270	---	---	---	---	---	---	375	2820	93.4	1004	18.2	0.271	2343	*
		1400	---	---	---	---	---	415	2831	93.9	1004			2373	*
		1470	---	---	---	---	---	434	2819	94.0	1004			2386	*
		1670	---	---	---	---	---	494	2825	94.6	1004			2419	*
		1935	---	---	---	---	---	573	2828	95.1	1004			2455	*
		2270	---	---	---	---	---	671	2823	95.5	1004			2488	*

Nota (\*) - VENTILAZIONE SOLO L.O. / FAN ONLY SIDE COMMUTATOR

Nota (°) - Regolazione di campo / Field weakening



Potenza eccitazione Excitation power (w) 3500	Tipo Size MGL C 315 S
Cost. tempo eccitaz. Field time constant (ms) 590	Ventilazione Ventilation IC 06
Massa del motore Mass of the motor (Kg) 1970	
Momento d'inerzia rotore Rotor inertia moment (Kgm2) 8.50	

Avv.	Velocità nominale n/min a tensione nominale di armatura Rated speed (rev/min) at rated voltage							Potenza Power kW	Coppia vel.nomin. Torque at rated speed Nm	Rendimento Efficiency %	Circuito di armatura Armature circuit			Max giri Max. speed (°)		
	400	440	460	520	600	700	810				Corrente Current Amp	Res. 115°C mOhm	Ind. mH			
47	1190	---	---	---	---	---	---	327	2624	92.5	884	24.4	0.241	2480	*	
		1315	---	---	---	---	---	362	2629	93.1	884			2500		
		1380	---	---	---	---	---	---	379	2623	93.2			884		2500
			---	---	---	---	---	---	431	2621	93.8			884		2500
		1570	---	---	---	---	---	---	501	2629	94.5			884		2500
			---	---	---	---	---	---	588	2630	95.0			884		2500
		1820	---	---	---	---	---	---	2135	2485	95.5			856		2500
			---	---	---	---	---	---	2485	662	2544			95.5		856
48	1175	---	---	---	---	---	---	364	2958	92.9	980	21.6	0.254	2500	*	
		1300	---	---	---	---	---	402	2953	93.2	980			2500		
		1360	---	---	---	---	---	---	421	2956	93.4			980		2500
			---	---	---	---	---	---	479	2951	94.0			980		2500
		1550	---	---	---	---	---	---	556	2950	94.6			980		2500
			---	---	---	---	---	---	2110	2455	95.2			980		2500
		1800	---	---	---	---	---	---	653	2955	95.2			980		2500
			---	---	---	---	---	---	2455	759	2952			95.6		980
49	1085	---	---	---	---	---	---	333	2931	92.5	900	24.5	0.335	2441	*	
		1200	---	---	---	---	---	368	2928	92.9	900			2480		
		1260	---	---	---	---	---	---	386	2925	93.2			900		2497
			---	---	---	---	---	---	439	2932	93.8			900		2500
		1430	---	---	---	---	---	---	510	2925	94.4			900		2500
			---	---	---	---	---	---	1950	2270	95.1			900		2500
		1665	---	---	---	---	---	---	599	2933	95.1			900		2500
			---	---	---	---	---	---	2270	696	2928			95.5		900
50	1005	---	---	---	---	---	---	299	2841	91.7	815	30.6	0.338	2389	*	
		1110	---	---	---	---	---	331	2848	92.3	815			2429		
		1165	---	---	---	---	---	---	347	2844	92.6			815		2446
			---	---	---	---	---	---	395	2847	93.2			815		2492
		1325	---	---	---	---	---	---	460	2852	94.1			815		2500
			---	---	---	---	---	---	1810	2105	94.7			815		2500
		1540	---	---	---	---	---	---	540	2849	94.7			815		2500
			---	---	---	---	---	---	2105	628	2849			95.1		815
51	935	---	---	---	---	---	---	289	2952	91.5	790	32.8	0.420	2209	*	
		1035	---	---	---	---	---	320	2952	92.1	790			2246		
		1085	---	---	---	---	---	---	336	2957	92.5			790		2262
			---	---	---	---	---	---	383	2961	93.2			790		2304
		1235	---	---	---	---	---	---	445	2951	93.9			790		2347
			---	---	---	---	---	---	1690	1965	94.6			790		2389
		1440	---	---	---	---	---	---	523	2955	94.6			790		2389
			---	---	---	---	---	---	1965	608	2955			95.0		790
52	875	---	---	---	---	---	---	265	2892	91.4	725	36.8	0.502	2154	*	
		970	---	---	---	---	---	293	2884	91.8	725			2191		
		1020	---	---	---	---	---	---	308	2884	92.4			725		2208
			---	---	---	---	---	---	351	2889	93.1			725		2250
		1160	---	---	---	---	---	---	408	2886	93.8			725		2295
			---	---	---	---	---	---	1585	1845	94.4			725		2337
		1350	---	---	---	---	---	---	479	2886	94.4			725		2337
			---	---	---	---	---	---	1845	558	2888			95.0		725
53	825	---	---	---	---	---	---	242	2801	91.1	664	42.0	0.601	2280	*	
		915	---	---	---	---	---	268	2797	91.7	664			2325		
		960	---	---	---	---	---	---	281	2795	92.0			664		2345
			---	---	---	---	---	---	320	2803	92.7			664		2396
		1090	---	---	---	---	---	---	372	2797	93.4			664		2450
			---	---	---	---	---	---	1490	1735	94.2			664		2500
		1270	---	---	---	---	---	---	438	2807	94.2			664		2500
			---	---	---	---	---	---	1735	510	2807			94.8		664

Nota (\*) - VENTILAZIONE SOLO L.O. / FAN ONLY SIDE COMMUTATOR

Nota (°) - Regolazione di campo / Field weakening



Potenza eccitazione Excitation power (w) 3500	
Cost. tempo eccitaz. Field time constant (ms) 590	
Massa del motore Mass of the motor (Kg) 1970	
Momento d'inerzia rotore Rotor inertia moment (Kgm2) 8.50	
Tipo Size MGL C 315 S	
Ventilazione Ventilation IC 06	

Avv.	Velocità nominale n/min a tensione nominale di armatura Rated speed (rev/min) at rated voltage							Potenza Power kW	Coppia vel.nomin. Torque at rated speed Nm	Rendimento Efficiency %	Circuito di armatura Armature circuit			Max giri Max. speed (°)
	400	440	460	520	600	700	810				Corrente Current Amp	Res. 115°C mOhm	Ind. mH	
54	795	---	---	---	---	---	---	238	2859	90.4	658	46.6	0.552	2353
		880	---	---	---	---	---	264	2865	91.2	658			2403
		925	---	---	---	---	---	277	2860	91.5	658			2425
		1055	---	---	---	---	---	316	2860	92.4	658			2482
		1230	---	---	---	---	---	367	2849	93.0	658			2500
		1445	---	---	---	---	---	432	2855	93.8	658			2500
		1685	---	---	---	---	---	503	2851	94.4	658			2500
		1685	---	---	---	---	---	503	2851	94.4	658			2500
55	735	---	---	---	---	---	---	215	2793	89.6	600	55.6	0.602	2282
		815	---	---	---	---	---	239	2800	90.5	600			2333
		855	---	---	---	---	---	251	2803	90.9	600			2356
		975	---	---	---	---	---	286	2801	91.7	600			2415
		1140	---	---	---	---	---	333	2789	92.5	600			2477
		1340	---	---	---	---	---	392	2794	93.3	600			2500
		1560	---	---	---	---	---	457	2797	94.0	600			2500
		1560	---	---	---	---	---	457	2797	94.0	600			2500
56	685	---	---	---	---	---	---	205	2858	89.6	572	59.9	0.756	2139
		760	---	---	---	---	---	227	2852	90.2	572			2187
		800	---	---	---	---	---	239	2853	90.8	572			2209
		910	---	---	---	---	---	272	2854	91.4	572			2264
		1065	---	---	---	---	---	317	2842	92.4	572			2323
		1250	---	---	---	---	---	374	2857	93.4	572			2379
		1460	---	---	---	---	---	436	2852	94.1	572			2425
		1460	---	---	---	---	---	436	2852	94.1	572			2425
57	640	---	---	---	---	---	---	187	2790	89.0	525	67.5	0.871	2248
		715	---	---	---	---	---	208	2778	90.0	525			2306
		750	---	---	---	---	---	218	2776	90.3	525			2331
		855	---	---	---	---	---	249	2781	91.2	525			2397
		995	---	---	---	---	---	291	2793	92.4	525			2468
		1175	---	---	---	---	---	342	2779	93.1	525			2500
		1370	---	---	---	---	---	399	2781	93.8	525			2500
		1370	---	---	---	---	---	399	2781	93.8	525			2500
58	595	---	---	---	---	---	---	168	2696	87.5	480	87.2	0.863	2096
		660	---	---	---	---	---	187	2706	88.5	480			2151
		695	---	---	---	---	---	196	2693	88.8	480			2175
		795	---	---	---	---	---	225	2703	90.1	480			2238
		930	---	---	---	---	---	263	2701	91.3	480			2305
		1095	---	---	---	---	---	310	2703	92.3	480			2369
		1280	---	---	---	---	---	362	2701	93.1	480			2422
		1280	---	---	---	---	---	362	2701	93.1	480			2422
59	560	---	---	---	---	---	---	160	2728	87.0	460	96.2	1.01	2062
		620	---	---	---	---	---	178	2742	87.9	460			2118
		655	---	---	---	---	---	187	2726	88.4	460			2144
		750	---	---	---	---	---	214	2725	89.5	460			2209
		875	---	---	---	---	---	251	2739	90.9	460			2279
		1035	---	---	---	---	---	296	2731	91.9	460			2345
		1205	---	---	---	---	---	346	2742	92.9	460			2402
		1205	---	---	---	---	---	346	2742	92.9	460			2402
60	520	---	---	---	---	---	---	166	3048	87.4	475	90.5	1.22	1494
		580	---	---	---	---	---	185	3046	88.5	475			1520
		610	---	---	---	---	---	194	3037	88.8	475			1531
		700	---	---	---	---	---	222	3028	89.9	475			1560
		815	---	---	---	---	---	260	3046	91.2	475			1591
		965	---	---	---	---	---	306	3028	92.0	475			1619
		1125	---	---	---	---	---	358	3039	93.0	475			1642
		1125	---	---	---	---	---	358	3039	93.0	475			1642

Nota (\*) - VENTILAZIONE SOLO L.O. / FAN ONLY SIDE COMMUTATOR

Nota (°) - Regolazione di campo / Field weakening



Potenza eccitazione Excitation power (w)	3500	Tipo Size	MGL C 315 S
Cost. tempo eccitaz. Field time constant (ms)	590	Ventilazione Ventilation	IC 06
Massa del motore Mass of the motor (Kg)	1970		
Momento d'inerzia rotore Rotor inertia moment (Kgm2)	8.50		

Avv.	Velocità nominale n/min a tensione nominale di armatura Rated speed (rev/min) at rated voltage							Potenza Power kW	Coppia vel. nomin. Torque at rated speed Nm	Rendimento Efficiency %	Circuito di armatura Armature circuit			Max giri Max. speed (°)
	400	440	460	520	600	700	810				Corrente Current Amp	Res. 115°C mOhm	Ind. mH	
61	480	---	---	---	---	---	---	143	2845	86.8	412	112	1.61	1448
		535	---	---	---	---	---	159	2838	87.7	412			1474
		---	565	---	---	---	---	167	2823	88.1	412			1486
		---	---	645	---	---	---	191	2828	89.2	412			1516
		---	---	---	755	---	---	224	2833	90.6	412			1547
		---	---	---	---	890	---	264	2833	91.5	412			1576
		---	---	---	---	---	1040	309	2837	92.6	412			1600
62	445	---	---	---	---	---	---	137	2940	85.6	400	126	1.58	1333
		495	---	---	---	---	---	153	2952	86.9	400			1358
		---	520	---	---	---	---	161	2957	87.5	400			1369
		---	---	595	---	---	---	184	2953	88.5	400			1397
		---	---	---	700	---	---	216	2947	90.0	400			1425
		---	---	---	---	825	---	255	2952	91.1	400			1452
		---	---	---	---	---	970	298	2934	92.0	400			1474
63	415	---	---	---	---	---	---	124	2853	85.2	364	144	1.85	1410
		460	---	---	---	---	---	138	2865	86.2	364			1440
		---	485	---	---	---	---	145	2855	86.6	364			1453
		---	---	560	---	---	---	167	2848	88.2	364			1487
		---	---	---	655	---	---	195	2843	89.3	364			1522
		---	---	---	---	775	---	231	2846	90.7	364			1555
		---	---	---	---	---	905	271	2860	91.9	364			1582
64	385	---	---	---	---	---	---	113	2803	84.6	334	165	2.29	1376
		430	---	---	---	---	---	126	2798	85.7	334			1407
		---	455	---	---	---	---	132	2770	85.9	334			1420
		---	---	525	---	---	---	152	2765	87.5	334			1455
		---	---	---	615	---	---	178	2764	88.8	334			1491
		---	---	---	---	725	---	211	2779	90.2	334			1525
		---	---	---	---	---	850	247	2775	91.3	334			1553
65	365	---	---	---	---	---	---	103	2695	83.6	308	186	2.75	1343
		405	---	---	---	---	---	115	2712	84.9	308			1374
		---	430	---	---	---	---	121	2687	85.4	308			1388
		---	---	490	---	---	---	140	2728	87.4	308			1423
		---	---	---	575	---	---	164	2724	88.7	308			1460
		---	---	---	---	685	---	194	2704	90.0	308			1495
		---	---	---	---	---	800	227	2710	91.0	308			1524

Nota (\*) - VENTILAZIONE SOLO L.O. / FAN ONLY SIDE COMMUTATOR

Nota (°) - Regolazione di campo / Field weakening



Potenza eccitazione Excitation power	(w)	4000	Tipo Size	MGL C 315 M
Cost. tempo eccitaz. Field time constant	(ms)	640	Ventilazione Ventilation	IC 06
Massa del motore Mass of the motor	(Kg)	2150		
Momento d'inerzia rotore Rotor inertia moment	(Kgm2)	9.50		

Avv.	Velocità nominale n/min a tensione nominale di armatura Rated speed (rev/min) at rated voltage							Potenza Power kW	Coppia vel.nomin. Torque at rated speed Nm	Rendimento Efficiency %	Circuito di armatura Armature circuit			Max giri Max. speed (°)	*
	400	440	460	520	600	700	810				Corrente Current Amp	Res. 115°C mOhm	Ind. mH		
40	1630	---	---	---	---	---	---	569	3333	94.8	1500	8.69	0.113	2500	*
		1800	---	---	---	---	---	628	3332	95.2	1500			2500	*
		1885	---	---	---	---	---	657	3328	95.2	1500			2500	*
			2140	---	---	---	---	746	3329	95.6	1500			2500	*
41	1495	---	---	---	---	---	---	544	3475	94.4	1440	9.97	0.151	2500	*
		1650	---	---	---	---	---	601	3478	94.9	1440			2500	*
		1730	---	---	---	---	---	630	3477	95.1	1440			2500	*
			1965	---	---	---	---	715	3475	95.5	1440			2500	*
42	1375	---	---	---	---	---	---	491	3410	93.7	1310	13.3	0.138	2364	*
		1520	---	---	---	---	---	543	3411	94.2	1310			2392	*
		1590	---	---	---	---	---	569	3417	94.4	1310			2404	*
			1805	---	---	---	---	646	3418	94.8	1310			2435	*
43	1275	---	---	---	---	---	---	459	3438	93.6	1226	14.5	0.171	2249	*
		1410	---	---	---	---	---	508	3440	94.2	1226			2277	*
		1480	---	---	---	---	---	532	3433	94.3	1226			2289	*
			1680	---	---	---	---	604	3433	94.7	1226			2319	*
44	1190	---	---	---	---	---	---	428	3435	93.4	1145	16.3	0.214	2141	*
		1320	---	---	---	---	---	473	3422	93.9	1145			2168	*
		1380	---	---	---	---	---	496	3432	94.2	1145			2180	*
			1570	---	---	---	---	563	3424	94.6	1145			2210	*
45	1120	---	---	---	---	---	---	392	3342	93.3	1050	18.5	0.256	2279	*
		1235	---	---	---	---	---	433	3348	93.7	1050			2311	*
		1295	---	---	---	---	---	454	3348	94.0	1050			2325	*
			1470	---	---	---	---	516	3352	94.5	1050			2362	*
46	1050	---	---	---	---	---	---	374	3401	93.1	1004	20.0	0.319	2068	*
		1165	---	---	---	---	---	414	3393	93.7	1004			2096	*
		1220	---	---	---	---	---	433	3389	93.8	1004			2109	*
			1385	---	---	---	---	493	3399	94.4	1004			2141	*
46	1050	---	---	---	---	---	---	573	3399	95.1	1004	20.0	0.319	2174	*
		1610	---	---	---	---	---	671	3399	95.5	1004			2205	*
			1885	---	---	---	---	780	3393	95.9	1004			2231	*
		2195	---	---	---	---	---	---	---	---	---			---	---

Nota (\*) - VENTILAZIONE SOLO L.O. / FAN ONLY SIDE COMMUTATOR

Nota (°) - Regolazione di campo / Field weakening



Potenza eccitazione Excitation power	(w)	4000	Tipo Size	MGL C 315 M
Cost. tempo eccitaz. Field time constant	(ms)	640	Ventilazione Ventilation	IC 06
Massa del motore Mass of the motor	(Kg)	2150		
Momento d'inerzia rotore Rotor inertia moment	(Kgm2)	9.50		

Avv.	Velocità nominale n/min a tensione nominale di armatura Rated speed (rev/min) at rated voltage							Potenza Power kW	Coppia vel.nomin. Torque at rated speed Nm	Rendimento Efficiency %	Circuito di armatura Armature circuit			Max giri Max. speed (°)
	400	440	460	520	600	700	810				Corrente Current Amp	Res. 115°C mOhm	Ind. mH	
47	985	---	---	---	---	---	---	326	3160	92.2	884	26.8	0.282	2187
		1090	---	---	---	---	---	361	3163	92.8				2221
		---	1145	---	---	---	---	378	3153	93.0				2236
		---	---	1300	---	---	---	430	3159	93.5				2274
		---	---	---	1510	---	---	500	3162	94.3				2314
		---	---	---	---	1775	---	587	3158	94.9				2353
		---	---	---	---	---	2065	683	3158	95.4				2384
		---	---	---	---	---	---	---	---	---				---
48	975	---	---	---	---	---	---	362	3545	92.3	980	23.6	0.298	2285
		1080	---	---	---	---	---	401	3546	93.0				2323
		---	1130	---	---	---	---	420	3549	93.2				2339
		---	---	1285	---	---	---	478	3552	93.8				2382
		---	---	---	1495	---	---	555	3545	94.4				2427
		---	---	---	---	1755	---	652	3548	95.0				2469
		---	---	---	---	---	2040	758	3548	95.5				2500
		---	---	---	---	---	---	---	---	---				---
49	900	---	---	---	---	---	---	332	3523	92.2	900	26.9	0.394	2165
		995	---	---	---	---	---	367	3522	92.7				2202
		---	1045	---	---	---	---	385	3518	93.0				2218
		---	---	1190	---	---	---	438	3515	93.6				2260
		---	---	---	1380	---	---	509	3522	94.3				2303
		---	---	---	---	1620	---	598	3525	94.9				2345
		---	---	---	---	---	1885	696	3526	95.5				2379
		---	---	---	---	---	---	---	---	---				---
50	830	---	---	---	---	---	---	298	3429	91.4	815	33.6	0.396	2111
		920	---	---	---	---	---	330	3425	92.0				2150
		---	965	---	---	---	---	346	3424	92.3				2166
		---	---	1100	---	---	---	394	3420	93.0				2210
		---	---	---	1280	---	---	458	3417	93.7				2255
		---	---	---	---	1500	---	539	3431	94.5				2298
		---	---	---	---	---	1750	627	3421	95.0				2334
		---	---	---	---	---	---	---	---	---				---
51	775	---	---	---	---	---	---	288	3549	91.1	790	36.0	0.493	1947
		860	---	---	---	---	---	319	3542	91.8				1982
		---	900	---	---	---	---	335	3554	92.2				1997
		---	---	1025	---	---	---	381	3550	92.7				2037
		---	---	---	1195	---	---	444	3548	93.7				2078
		---	---	---	---	1405	---	522	3548	94.4				2118
		---	---	---	---	---	1635	607	3545	94.9				2151
		---	---	---	---	---	---	---	---	---				---
52	725	---	---	---	---	---	---	264	3477	91.0	725	40.4	0.591	1893
		805	---	---	---	---	---	292	3464	91.5				1929
		---	845	---	---	---	---	306	3458	91.8				1944
		---	---	960	---	---	---	349	3472	92.6				1984
		---	---	---	1120	---	---	407	3470	93.6				2026
		---	---	---	---	1315	---	478	3471	94.2				2066
		---	---	---	---	---	1535	557	3465	94.8				2099
		---	---	---	---	---	---	---	---	---				---
53	680	---	---	---	---	---	---	240	3370	90.4	664	46.1	0.708	2007
		755	---	---	---	---	---	267	3377	91.4				2049
		---	795	---	---	---	---	280	3363	91.7				2068
		---	---	905	---	---	---	319	3366	92.4				2117
		---	---	---	1055	---	---	371	3358	93.1				2168
		---	---	---	---	1240	---	437	3365	94.0				2217
		---	---	---	---	---	1445	509	3364	94.6				2258
		---	---	---	---	---	---	---	---	---				---

Nota (\*) - VENTILAZIONE SOLO L.O. / FAN ONLY SIDE COMMUTATOR

Nota (°) - Regolazione di campo / Field weakening



Potenza eccitazione Excitation power (w) 4000	
Cost. tempo eccitaz. Field time constant (ms) 640	
Massa del motore Mass of the motor (Kg) 2150	
Momento d'inerzia rotore Rotor inertia moment (Kgm2) 9.50	
Tipo Size MGL C 315 M	
Ventilazione Ventilation IC 06	

Avv.	Velocità nominale n/min a tensione nominale di armatura Rated speed (rev/min) at rated voltage							Potenza Power kW	Coppia vel.nomin. Torque at rated speed Nm	Rendimento Efficiency %	Circuito di armatura Armature circuit			Max giri Max. speed (°)	
	400	440	460	520	600	700	810				Corrente Current Amp	Res. 115°C mOhm	Ind. mH		
54	655	---	---	---	---	---	---	236	3441	89.7	658	51.1	0.649	2077	
		730	---	---	---	---	---	262	3427	90.5					2125
		765	---	---	---	---	---	275	3433	90.9					2146
		875	---	---	---	---	---	314	3427	91.8					2200
		1020	---	---	---	---	---	366	3427	92.7					2258
		1200	---	---	---	---	---	431	3430	93.6					2313
		1395	---	---	---	---	---	502	3436	94.2					2359
		---	---	---	---	---	---	---	---	---					---
55	605	---	---	---	---	---	---	214	3378	89.2	600	60.9	0.707	2008	
		675	---	---	---	---	---	237	3353	89.8					2056
		710	---	---	---	---	---	249	3349	90.2					2078
		810	---	---	---	---	---	285	3360	91.3					2133
		945	---	---	---	---	---	332	3355	92.2					2192
		1110	---	---	---	---	---	391	3364	93.1					2249
		1295	---	---	---	---	---	456	3363	93.8					2296
		---	---	---	---	---	---	---	---	---					---
56	565	---	---	---	---	---	---	203	3431	88.7	572	65.7	0.889	1877	
		630	---	---	---	---	---	226	3426	89.8					1922
		660	---	---	---	---	---	237	3429	90.1					1942
		755	---	---	---	---	---	271	3428	91.1					1995
		880	---	---	---	---	---	316	3429	92.1					2050
		1040	---	---	---	---	---	372	3416	92.9					2103
		1210	---	---	---	---	---	435	3433	93.9					2147
		---	---	---	---	---	---	---	---	---					---
57	530	---	---	---	---	---	---	186	3351	88.6	525	74.0	1.02	1975	
		590	---	---	---	---	---	207	3350	89.6					2029
		620	---	---	---	---	---	217	3342	89.9					2053
		705	---	---	---	---	---	248	3359	90.8					2116
		825	---	---	---	---	---	289	3345	91.7					2183
		975	---	---	---	---	---	341	3340	92.8					2247
		1135	---	---	---	---	---	398	3349	93.6					2301
		---	---	---	---	---	---	---	---	---					---
58	490	---	---	---	---	---	---	167	3255	87.0	480	95.4	1.01	1830	
		545	---	---	---	---	---	186	3259	88.1					1881
		575	---	---	---	---	---	195	3238	88.3					1904
		655	---	---	---	---	---	223	3251	89.3					1963
		770	---	---	---	---	---	261	3237	90.6					2026
		910	---	---	---	---	---	309	3243	92.0					2086
		1060	---	---	---	---	---	361	3252	92.8					2137
		---	---	---	---	---	---	---	---	---					---
59	460	---	---	---	---	---	---	158	3280	85.9	460	105	1.18	1748	
		515	---	---	---	---	---	177	3282	87.5					1852
		540	---	---	---	---	---	186	3289	87.9					1876
		620	---	---	---	---	---	213	3281	89.0					1938
		725	---	---	---	---	---	249	3280	90.2					2003
		855	---	---	---	---	---	294	3284	91.3					2066
		1000	---	---	---	---	---	344	3285	92.3					2119
		---	---	---	---	---	---	---	---	---					---
60	430	---	---	---	---	---	---	164	3642	86.3	475	99.3	1.43	1327	
		480	---	---	---	---	---	183	3641	87.6					1353
		505	---	---	---	---	---	193	3650	88.3					1364
		575	---	---	---	---	---	221	3670	89.5					1392
		675	---	---	---	---	---	258	3650	90.5					1421
		800	---	---	---	---	---	305	3641	91.7					1449
		930	---	---	---	---	---	357	3666	92.8					1471
		---	---	---	---	---	---	---	---	---					---

Nota (\*) - VENTILAZIONE SOLO L.O. / FAN ONLY SIDE COMMUTATOR

Nota (°) - Regolazione di campo / Field weakening





Potenza eccitazione Excitation power (w) 4000	Tipo Size MGL C 315 M
Cost. tempo eccitaz. Field time constant (ms) 640	Ventilazione Ventilation IC 06
Massa del motore Mass of the motor (Kg) 2150	
Momento d'inerzia rotore Rotor inertia moment (Kgm2) 9.50	

Avv.	Velocità nominale n/min a tensione nominale di armatura Rated speed (rev/min) at rated voltage							Potenza Power kW	Coppia vel. nomin. Torque at rated speed Nm	Rendimento Efficiency %	Circuito di armatura Armature circuit			Max giri Max. speed (°)
	400	440	460	520	600	700	810				Corrente Current Amp	Res. 115°C mOhm	Ind. mH	
61	395	---	---	---	---	---	---	141	3409	85.6	412	122	1.90	1277
		440	---	---	---	---	---	157	3407	86.6	412			1303
		465	---	---	---	---	---	166	3409	87.6	412			1314
		535	---	---	---	---	---	190	3391	88.7	412			1343
		625	---	---	---	---	---	222	3392	89.8	412			1373
		740	---	---	---	---	---	263	3394	91.2	412			1401
		865	---	---	---	---	---	308	3400	92.3	412			1424
62	365	---	---	---	---	---	---	135	3532	84.4	400	138	1.85	1173
		410	---	---	---	---	---	151	3517	85.8	400			1197
		430	---	---	---	---	---	159	3531	86.4	400			1207
		495	---	---	---	---	---	183	3530	88.0	400			1234
		580	---	---	---	---	---	214	3523	89.2	400			1261
		685	---	---	---	---	---	254	3541	90.7	400			1287
		800	---	---	---	---	---	297	3545	91.7	400			1308
63	340	---	---	---	---	---	---	122	3427	83.8	364	158	2.17	1242
		380	---	---	---	---	---	137	3443	85.5	364			1270
		400	---	---	---	---	---	144	3438	86.0	364			1283
		460	---	---	---	---	---	165	3425	87.2	364			1315
		540	---	---	---	---	---	194	3431	88.8	364			1349
		640	---	---	---	---	---	230	3432	90.3	364			1381
		750	---	---	---	---	---	269	3425	91.2	364			1407
64	320	---	---	---	---	---	---	111	3312	83.1	334	181	2.70	1207
		355	---	---	---	---	---	124	3336	84.4	334			1237
		375	---	---	---	---	---	131	3336	85.3	334			1250
		430	---	---	---	---	---	151	3353	86.9	334			1283
		505	---	---	---	---	---	177	3347	88.3	334			1318
		600	---	---	---	---	---	210	3342	89.8	334			1350
		705	---	---	---	---	---	246	3332	90.9	334			1377
65	298	---	---	---	---	---	---	102	3269	82.8	308	204	3.24	1133
		335	---	---	---	---	---	114	3250	84.1	308			1205
		350	---	---	---	---	---	120	3274	84.7	308			1218
		405	---	---	---	---	---	138	3254	86.2	308			1252
		475	---	---	---	---	---	162	3257	87.7	308			1287
		565	---	---	---	---	---	193	3262	89.5	308			1320
		665	---	---	---	---	---	226	3245	90.6	308			1347

Nota (\*) - VENTILAZIONE SOLO L.O. / FAN ONLY SIDE COMMUTATOR

Nota (°) - Regolazione di campo / Field weakening



Potenza eccitazione Excitation power	(w)	4500	Tipo Size Ventilazione Ventilation	MGL C 315 L  IC 06
Cost. tempo eccitaz. Field time constant	(ms)	730		
Massa del motore Mass of the motor	(Kg)	2370		
Momento d'inerzia rotore Rotor inertia moment	(Kgm2)	10.50		

Avv.	Velocità nominale n/min a tensione nominale di armatura Rated speed (rev/min) at rated voltage							Potenza Power kW	Coppia vel.nomin. Torque at rated speed Nm	Rendimento Efficiency %	Circuito di armatura Armature circuit			Max giri Max. speed (°)	*
	400	440	460	520	600	700	810				Corrente Current Amp	Res. 115°C mOhm	Ind. mH		
40	1350	---	---	---	---	---	---	568	4018	94.7	1500	9.63	0.134	2424	*
		1490	---	---	---	---	---	627	4018	95.0	1500			2454	*
		---	1560	---	---	---	---	656	4016	95.1	1500			2467	*
		---	---	1770	---	---	---	745	4019	95.5	1500			2500	*
41	1235	---	---	---	---	---	---	543	4199	94.3	1440	11.0	0.179	2187	*
		1365	---	---	---	---	---	600	4197	94.7	1440			2213	
		---	1430	---	---	---	---	628	4194	94.8	1440			2225	
		---	---	1625	---	---	---	714	4196	95.4	1440			2255	
		---	---	---	1880	---	---	827	4201	95.7	1440			2286	
42	1135	---	---	---	---	---	---	490	4123	93.5	1310	14.7	0.163	2082	*
		1255	---	---	---	---	---	541	4116	93.9	1310			2109	
		---	1315	---	---	---	---	567	4117	94.1	1310			2121	
		---	---	1495	---	---	---	645	4120	94.7	1310			2150	
		---	---	---	1735	---	---	748	4117	95.2	1310			2181	
43	1055	---	---	---	---	---	---	458	4146	93.4	1226	16.1	0.202	1976	*
		1165	---	---	---	---	---	506	4148	93.8	1226			2002	
		---	1220	---	---	---	---	530	4148	94.0	1226			2013	
		---	---	1390	---	---	---	603	4143	94.6	1226			2042	
		---	---	---	1610	---	---	700	4152	95.2	1226			2072	
44	985	---	---	---	---	---	---	426	4130	93.0	1145	18.1	0.253	1876	*
		1090	---	---	---	---	---	472	4135	93.7	1145			1901	
		---	1140	---	---	---	---	494	4138	93.8	1145			1912	
		---	---	1295	---	---	---	562	4144	94.4	1145			1940	
		---	---	---	1505	---	---	652	4137	94.9	1145			1969	
		---	---	---	---	1765	---	766	4144	95.6	1145			1996	
45	920	---	---	---	---	---	---	390	4048	92.9	1050	20.5	0.303	2001	*
		1020	---	---	---	---	---	432	4044	93.5	1050			2031	
		---	1070	---	---	---	---	452	4034	93.6	1050			2044	
		---	---	1215	---	---	---	514	4040	94.1	1050			2078	
		---	---	---	1410	---	---	597	4043	94.8	1050			2114	
		---	---	---	---	1655	---	701	4045	95.4	1050			2148	
46	870	---	---	---	---	---	---	372	4083	92.6	1004	22.2	0.378	1807	*
		960	---	---	---	---	---	412	4098	93.3	1004			1833	
		---	1005	---	---	---	---	432	4105	93.5	1004			1845	
		---	---	1145	---	---	---	491	4095	94.0	1004			1875	
		---	---	---	1330	---	---	571	4100	94.8	1004			1906	
		---	---	---	---	1560	---	670	4101	95.3	1004			1935	
		---	---	---	---	---	1815	779	4099	95.8	1004			1959	
		---	---	---	---	---	---	---	---	---	---			---	

Nota (\*) - VENTILAZIONE SOLO L.O. / FAN ONLY SIDE COMMUTATOR

Nota (°) - Regolazione di campo / Field weakening



Potenza eccitazione Excitation power (w) 4500	
Cost. tempo eccitaz. Field time constant (ms) 730	
Massa del motore Mass of the motor (Kg) 2370	
Momento d'inerzia rotore Rotor inertia moment (Kgm2) 10.50	
Tipo Size MGL C 315 L	
Ventilazione Ventilation IC 06	

Avv.	Velocità nominale n/min a tensione nominale di armatura Rated speed (rev/min) at rated voltage							Potenza Power kW	Coppia vel.nomin. Torque at rated speed Nm	Rendimento Efficiency %	Circuito di armatura Armature circuit			Max giri Max. speed (°)	
	400	440	460	520	600	700	810				Corrente Current Amp	Res. 115°C mOhm	Ind. mH		
47	810	---	---	---	---	---	---	324	3820	91.6	884	29.6	0.332	1908	*
		900	---	---	---	---	---	359	3809	92.3	884			1940	
		945	---	---	---	---	---	377	3810	92.7	884			1954	
		1075	---	---	---	---	---	429	3811	93.3	884			1990	
		1250	---	---	---	---	---	499	3812	94.1	884			2028	
		1470	---	---	---	---	---	586	3807	94.7	884			2063	
		1710	---	---	---	---	---	682	3809	95.2	884			2093	
		---	---	---	---	---	---	---	---	---	---			---	
48	805	---	---	---	---	---	---	360	4270	91.8	980	26.2	0.353	2013	*
		890	---	---	---	---	---	399	4281	92.5	980			2048	
		930	---	---	---	---	---	418	4292	92.7	980			2064	
		1060	---	---	---	---	---	476	4288	93.4	980			2105	
		1235	---	---	---	---	---	554	4284	94.2	980			2147	
		1450	---	---	---	---	---	651	4287	94.9	980			2188	
		1685	---	---	---	---	---	757	4290	95.4	980			2221	
		---	---	---	---	---	---	---	---	---	---			---	
49	740	---	---	---	---	---	---	330	4258	91.7	900	29.8	0.467	1900	*
		820	---	---	---	---	---	365	4251	92.2	900			1934	
		860	---	---	---	---	---	383	4253	92.5	900			1950	
		980	---	---	---	---	---	437	4258	93.4	900			1989	
		1140	---	---	---	---	---	508	4255	94.1	900			2030	
		1340	---	---	---	---	---	597	4254	94.8	900			2069	
		1560	---	---	---	---	---	694	4248	95.2	900			2102	
		---	---	---	---	---	---	---	---	---	---			---	
50	685	---	---	---	---	---	---	296	4126	90.8	815	37.2	0.469	1847	*
		760	---	---	---	---	---	328	4121	91.5	815			1882	
		795	---	---	---	---	---	344	4132	91.8	815			1898	
		905	---	---	---	---	---	392	4136	92.5	815			1939	
		1055	---	---	---	---	---	457	4137	93.5	815			1981	
		1240	---	---	---	---	---	537	4135	94.1	815			2022	
		1445	---	---	---	---	---	626	4137	94.8	815			2056	
		---	---	---	---	---	---	---	---	---	---			---	
51	635	---	---	---	---	---	---	286	4301	90.5	790	39.9	0.584	1699	*
		705	---	---	---	---	---	317	4294	91.2	790			1731	
		740	---	---	---	---	---	333	4297	91.6	790			1746	
		845	---	---	---	---	---	380	4294	92.5	790			1783	
		985	---	---	---	---	---	442	4285	93.2	790			1821	
		1160	---	---	---	---	---	520	4281	94.0	790			1858	
		1350	---	---	---	---	---	606	4287	94.7	790			1889	
		---	---	---	---	---	---	---	---	---	---			---	
52	595	---	---	---	---	---	---	262	4205	90.3	725	44.8	0.699	1647	*
		660	---	---	---	---	---	290	4196	90.9	725			1680	
		695	---	---	---	---	---	305	4191	91.5	725			1694	
		795	---	---	---	---	---	348	4180	92.3	725			1732	
		925	---	---	---	---	---	405	4181	93.1	725			1771	
		1085	---	---	---	---	---	476	4189	93.8	725			1808	
		1265	---	---	---	---	---	555	4190	94.5	725			1839	
		---	---	---	---	---	---	---	---	---	---			---	
53	560	---	---	---	---	---	---	239	4076	90.0	664	51.1	0.839	1748	*
		620	---	---	---	---	---	265	4082	90.7	664			1788	
		655	---	---	---	---	---	278	4053	91.0	664			1805	
		745	---	---	---	---	---	317	4063	91.8	664			1850	
		870	---	---	---	---	---	370	4061	92.9	664			1898	
		1025	---	---	---	---	---	435	4053	93.6	664			1944	
		1190	---	---	---	---	---	507	4068	94.3	664			1982	
		---	---	---	---	---	---	---	---	---	---			---	

Nota (\*) - VENTILAZIONE SOLO L.O. / FAN ONLY SIDE COMMUTATOR

Nota (°) - Regolazione di campo / Field weakening



Potenza eccitazione Excitation power	(w)	4500	Tipo Size Ventilazione Ventilation	MGL C 315 L  IC 06
Cost. tempo eccitaz. Field time constant	(ms)	730		
Massa del motore Mass of the motor	(Kg)	2370		
Momento d'inerzia rotore Rotor inertia moment	(Kgm2)	10.50		

Avv.	Velocità nominale n/min a tensione nominale di armatura Rated speed (rev/min) at rated voltage							Potenza Power kW	Coppia vel.nomin. Torque at rated speed Nm	Rendimento Efficiency %	Circuito di armatura Armature circuit			Max giri Max. speed (°)
	400	440	460	520	600	700	810				Corrente Current Amp	Res. 115°C mOhm	Ind. mH	
54	540	---	---	---	---	---	---	234	4138	88.9	658	56.6	0.768	1814
		600	---	---	---	---	---	260	4138	89.8				1858
		630	---	---	---	---	---	273	4138	90.2				1878
		720	---	---	---	---	---	312	4138	91.2				1929
		840	---	---	---	---	---	364	4138	92.2				1983
		990	---	---	---	---	---	429	4138	93.1				2035
		1155	---	---	---	---	---	501	4142	94.0				2079
55	500	---	---	---	---	---	---	212	4049	88.3	600	67.5	0.835	1747
		555	---	---	---	---	---	235	4043	89.0				1793
		580	---	---	---	---	---	247	4067	89.5				1813
		665	---	---	---	---	---	283	4064	90.7				1865
		775	---	---	---	---	---	330	4066	91.7				1920
		915	---	---	---	---	---	390	4070	92.9				1973
		1070	---	---	---	---	---	455	4061	93.6				2017
56	465	---	---	---	---	---	---	201	4128	87.8	572	72.9	1.05	1629
		515	---	---	---	---	---	224	4153	89.0				1671
		545	---	---	---	---	---	235	4118	89.3				1690
		620	---	---	---	---	---	269	4143	90.4				1739
		725	---	---	---	---	---	314	4136	91.5				1790
		855	---	---	---	---	---	371	4144	92.7				1840
		1000	---	---	---	---	---	433	4135	93.5				1991
57	435	---	---	---	---	---	---	184	4039	87.6	525	82.1	1.21	1652
		485	---	---	---	---	---	205	4036	88.7				1766
		510	---	---	---	---	---	215	4026	89.0				1789
		580	---	---	---	---	---	246	4050	90.1				1848
		680	---	---	---	---	---	288	4044	91.4				1910
		800	---	---	---	---	---	339	4047	92.2				1970
		935	---	---	---	---	---	397	4055	93.4				2021
58	400	---	---	---	---	---	---	165	3939	85.9	480	106	1.19	1524
		445	---	---	---	---	---	184	3948	87.1				1629
		470	---	---	---	---	---	193	3921	87.4				1650
		540	---	---	---	---	---	221	3908	88.5				1705
		630	---	---	---	---	---	259	3926	89.9				1763
		750	---	---	---	---	---	307	3909	91.4				1819
		875	---	---	---	---	---	359	3918	92.3				1866
59	375	---	---	---	---	---	---	156	3973	84.8	460	117	1.39	1429
		420	---	---	---	---	---	174	3956	86.0				1595
		440	---	---	---	---	---	184	3993	87.0				1625
		505	---	---	---	---	---	211	3990	88.2				1682
		595	---	---	---	---	---	247	3964	89.5				1742
		705	---	---	---	---	---	293	3969	91.0				1801
		825	---	---	---	---	---	343	3970	92.1				1850
60	350	---	---	---	---	---	---	162	4420	85.3	475	110	1.69	1166
		390	---	---	---	---	---	181	4432	86.6				1190
		415	---	---	---	---	---	190	4372	87.0				1201
		475	---	---	---	---	---	219	4403	88.7				1228
		555	---	---	---	---	---	256	4405	89.8				1256
		655	---	---	---	---	---	303	4417	91.1				1282
		770	---	---	---	---	---	355	4403	92.3				1304

Nota (\*) - VENTILAZIONE SOLO L.O. / FAN ONLY SIDE COMMUTATOR

Nota (°) - Regolazione di campo / Field weakening



Potenza eccitazione Excitation power (w) 4500	Tipo Size MGL C 315 L
Cost. tempo eccitaz. Field time constant (ms) 730	Ventilazione Ventilation IC 06
Massa del motore Mass of the motor (Kg) 2370	
Momento d'inerzia rotore Rotor inertia moment (Kgm2) 10.50	

Avv.	Velocità nominale n/min a tensione nominale di armatura Rated speed (rev/min) at rated voltage							Potenza Power kW	Coppia vel. nomin. Torque at rated speed Nm	Rendimento Efficiency %	Circuito di armatura Armature circuit			Max giri Max. speed (°)
	400	440	460	520	600	700	810				Corrente Current Amp	Res. 115°C mOhm	Ind. mH	
61	325	---	---	---	---	---	---	139	4084	84.3	412	136	2.25	1115
		360	---	---	---	---	---	155	4112	85.5	412			1139
		380	---	---	---	---	---	164	4121	86.5	412			1150
			435	---	---	---	---	188	4127	87.8	412			1177
		515	---	---	---	---	---	221	4098	89.4	412			1205
			605	---	---	---	---	261	4120	90.5	412			1231
		710	---	---	---	---	---	306	4116	91.7	412			1253
62	298	---	---	---	---	---	---	133	4262	83.1	400	153	2.19	1021
		335	---	---	---	---	---	149	4247	84.7	400			1043
		350	---	---	---	---	---	157	4284	85.3	400			1053
			405	---	---	---	---	181	4268	87.0	400			1078
		475	---	---	---	---	---	212	4262	88.3	400			1104
			565	---	---	---	---	252	4259	90.0	400			1128
		660	---	---	---	---	---	295	4268	91.0	400			1148
63	277	---	---	---	---	---	---	120	4137	82.4	364	175	2.57	1053
		310	---	---	---	---	---	135	4159	84.3	364			1108
		325	---	---	---	---	---	142	4172	84.8	364			1120
			375	---	---	---	---	163	4151	86.1	364			1151
		445	---	---	---	---	---	192	4120	87.9	364			1183
			525	---	---	---	---	228	4147	89.5	364			1213
		615	---	---	---	---	---	268	4161	90.9	364			1238
64	258	---	---	---	---	---	---	109	4034	81.6	334	201	3.19	982
		290	---	---	---	---	---	122	4017	83.0	334			1076
		305	---	---	---	---	---	129	4039	84.0	334			1088
			350	---	---	---	---	149	4065	85.8	334			1120
		415	---	---	---	---	---	175	4027	87.3	334			1152
			495	---	---	---	---	208	4013	89.0	334			1183
		580	---	---	---	---	---	244	4017	90.2	334			1208
65	242	---	---	---	---	---	---	99.8	3938	81.0	308	227	3.84	921
		272	---	---	---	---	---	112	3932	82.6	308			1033
		287	---	---	---	---	---	118	3926	83.3	308			1057
			330	---	---	---	---	136	3935	84.9	308			1089
		390	---	---	---	---	---	161	3942	87.1	308			1122
			465	---	---	---	---	191	3922	88.6	308			1153
		545	---	---	---	---	---	224	3925	89.8	308			1179

Nota (\*) - VENTILAZIONE SOLO L.O. / FAN ONLY SIDE COMMUTATOR

Nota (°) - Regolazione di campo / Field weakening



Potenza eccitazione  
Excitation power (w) 5200  
Cost. tempo eccitaz.  
Field time constant (ms) 800  
Massa del motore  
Mass of the motor (Kg) 2650  
Momento d'inerzia rotore  
Rotor inertia moment (Kgm2) 12.0

Tipo  
Size MGL C 315 P  
Ventilazione  
Ventilation IC 06

Avv.	Velocità nominale n/min a tensione nominale di armatura Rated speed (rev/min) at rated voltage							Potenza Power kW	Coppia vel.nomin. Torque at rated speed Nm	Rendimento Efficiency %	Circuito di armatura Armature circuit			Max giri Max. speed (°)		
	400	440	460	520	600	700	810				Corrente Current Amp	Res. 115°C mOhm	Ind. mH			
40	1105	---	---	---	---	---	---	566	4891	94.3	1500	10.8	0.160	2126	*	
		1220	---	---	---	---	---	625	4892	94.7	1500					2154
		1280	---	---	---	---	---	655	4887	94.9	1500					2167
		1455	---	---	---	---	---	744	4883	95.4	1500					2198
41	1015	---	---	---	---	---	---	541	5090	93.9	1440	12.4	0.214	1911	*	
		1120	---	---	---	---	---	598	5099	94.4	1440					1936
		1175	---	---	---	---	---	626	5088	94.5	1440					1947
		1335	---	---	---	---	---	712	5093	95.1	1440					1975
42	930	---	---	---	---	---	---	487	5001	92.9	1310	16.5	0.194	1812	*	
		1030	---	---	---	---	---	539	4997	93.5	1310					1837
		1075	---	---	---	---	---	565	5019	93.8	1310					1848
		1225	---	---	---	---	---	643	5012	94.4	1310					1876
43	865	---	---	---	---	---	---	455	5023	92.8	1226	18.0	0.240	1716	*	
		955	---	---	---	---	---	504	5040	93.4	1226					1739
		1000	---	---	---	---	---	528	5042	93.6	1226					1750
		1140	---	---	---	---	---	601	5034	94.3	1226					1777
44	805	---	---	---	---	---	---	424	5030	92.6	1145	20.3	0.302	1624	*	
		890	---	---	---	---	---	469	5032	93.1	1145					1647
		935	---	---	---	---	---	492	5025	93.4	1145					1657
		1065	---	---	---	---	---	560	5021	94.1	1145					1683
45	755	---	---	---	---	---	---	388	4907	92.4	1050	23.0	0.362	1735	*	
		835	---	---	---	---	---	429	4906	92.9	1050					1763
		875	---	---	---	---	---	450	4911	93.2	1050					1775
		995	---	---	---	---	---	512	4914	93.8	1050					1807
46	710	---	---	---	---	---	---	370	4976	92.1	1004	25.0	0.452	1560	*	
		785	---	---	---	---	---	410	4988	92.8	1004					1584
		825	---	---	---	---	---	430	4977	93.1	1004					1595
		940	---	---	---	---	---	489	4968	93.7	1004					1622
		---	---	---	---	---	---	569	4985	94.5	1004					
		---	---	---	---	---	---	668	4984	95.0	1004					1651
		---	---	---	---	---	---	777	4980	95.5	1004					1678
		---	---	---	---	---	---	---	---	---	---					1700

Nota (\*) - VENTILAZIONE SOLO L.O. / FAN ONLY SIDE COMMUTATOR

Nota (°) - Regolazione di campo / Field weakening



Potenza eccitazione Excitation power (w) 5200	Tipo
Cost. tempo eccitaz. (ms) 800	Size MGL C 315 P
Field time constant (ms) 800	Ventilazione
Massa del motore (Kg) 2650	Ventilation IC 06
Momento d'inerzia rotore (Kgm2) 12.0	

Avv.	Velocità nominale n/min a tensione nominale di armatura Rated speed (rev/min) at rated voltage							Potenza Power kW	Coppia vel.nomin. Torque at rated speed Nm	Rendimento Efficiency %	Circuito di armatura Armature circuit			Max giri Max. speed (°)	
	400	440	460	520	600	700	810				Corrente Current Amp	Res. 115°C mOhm	Ind. mH		
47	665	---	---	---	---	---	---	322	4624	91.1	884	33.2	0.396	1646	
		735	---	---	---	---	---	357	4638	91.8					1675
		---	770	---	---	---	---	374	4638	92.0					1688
		---	---	880	---	---	---	427	4634	92.9					1721
		---	---	---	1025	---	---	497	4630	93.7					1755
		---	---	---	---	1205	---	584	4628	94.4					1788
		---	---	---	---	---	1405	680	4622	95.0					1815
		---	---	---	---	---	---	---	---	---					---
48	655	---	---	---	---	---	---	358	5219	91.3	980	29.4	0.421	1751	
		725	---	---	---	---	---	397	5229	92.1					1784
		---	765	---	---	---	---	416	5193	92.3					1799
		---	---	870	---	---	---	474	5203	93.0					1837
		---	---	---	1010	---	---	552	5219	93.9					1877
		---	---	---	---	1190	---	649	5208	94.6					1914
		---	---	---	---	---	1385	755	5206	95.1					1946
		---	---	---	---	---	---	---	---	---					---
49	605	---	---	---	---	---	---	327	5161	90.8	900	33.4	0.558	1647	
		670	---	---	---	---	---	363	5174	91.7					1679
		---	705	---	---	---	---	381	5161	92.0					1693
		---	---	805	---	---	---	434	5148	92.7					1729
		---	---	---	935	---	---	505	5158	93.5					1767
		---	---	---	---	1100	---	594	5157	94.3					1804
		---	---	---	---	---	1280	692	5163	94.9					1834
		---	---	---	---	---	---	---	---	---					---
50	560	---	---	---	---	---	---	293	4996	89.9	815	41.8	0.559	1595	
		620	---	---	---	---	---	325	5006	90.6					1628
		---	650	---	---	---	---	342	5024	91.2					1643
		---	---	740	---	---	---	390	5033	92.0					1680
		---	---	---	865	---	---	454	5012	92.8					1720
		---	---	---	---	1015	---	535	5033	93.8					1758
		---	---	---	---	---	1185	624	5028	94.5					1789
		---	---	---	---	---	---	---	---	---					---
51	520	---	---	---	---	---	---	283	5197	89.6	790	44.8	0.697	1464	
		575	---	---	---	---	---	314	5215	90.3					1494
		---	605	---	---	---	---	330	5209	90.8					1507
		---	---	690	---	---	---	377	5218	91.8					1541
		---	---	---	805	---	---	439	5208	92.6					1577
		---	---	---	---	950	---	518	5207	93.7					1611
		---	---	---	---	---	1110	604	5196	94.4					1639
		---	---	---	---	---	---	---	---	---					---
52	485	---	---	---	---	---	---	259	5100	89.3	725	50.3	0.835	1416	
		540	---	---	---	---	---	288	5093	90.3					1466
		---	570	---	---	---	---	302	5059	90.6					1459
		---	---	650	---	---	---	345	5068	91.5					1493
		---	---	---	755	---	---	403	5097	92.6					1529
		---	---	---	---	890	---	474	5086	93.4					1563
		---	---	---	---	---	1040	553	5078	94.2					1592
		---	---	---	---	---	---	---	---	---					---
53	455	---	---	---	---	---	---	236	4953	88.9	664	57.4	1.00	1504	
		510	---	---	---	---	---	262	4906	89.7					1540
		---	535	---	---	---	---	276	4926	90.4					1556
		---	---	610	---	---	---	315	4931	91.2					1598
		---	---	---	710	---	---	368	4949	92.4					1642
		---	---	---	---	840	---	433	4922	93.2					1684
		---	---	---	---	---	980	505	4921	93.9					1719
		---	---	---	---	---	---	---	---	---					---

Nota (\*) - VENTILAZIONE SOLO L.O. / FAN ONLY SIDE COMMUTATOR

Nota (°) - Regolazione di campo / Field weakening





Potenza eccitazione Excitation power (w) 5200	Tipologia Tipo MGL C 315 P
Cost. tempo eccitaz. Field time constant (ms) 800	Ventilazione Ventilation IC 06
Massa del motore Mass of the motor (Kg) 2650	
Momento d'inerzia rotore Rotor inertia moment (Kgm2) 12.0	

Avv.	Velocità nominale n/min a tensione nominale di armatura Rated speed (rev/min) at rated voltage							Potenza Power kW	Coppia vel.nomin. Torque at rated speed Nm	Rendimento Efficiency %	Circuito di armatura Armature circuit			Max giri Max. speed (°)		
	400	440	460	520	600	700	810				Corrente Current Amp	Res. 115°C mOhm	Ind. mH			
54	440	---	---	---	---	---	---	232	5035	88.1	658	63.5	0.916	1564		
		490	---	---	---	---	---	258	5028	89.1					658	1605
		515	---	---	---	---	---	271	5025	89.5					658	1623
			590	---	---	---	---	310	5017	90.6					658	1671
		685	---	---	---	---	---	362	5046	91.7					658	1721
			810	---	---	---	---	427	5034	92.7					658	1769
		945	---	---	---	---	---	499	5042	93.6					658	1810
55	405	---	---	---	---	---	---	209	4928	87.1	600	75.7	0.996	1502		
		450	---	---	---	---	---	233	4944	88.3					600	1543
		475	---	---	---	---	---	245	4925	88.8					600	1562
			545	---	---	---	---	280	4906	89.7					600	1610
		635	---	---	---	---	---	328	4933	91.1					600	1661
			750	---	---	---	---	387	4927	92.1					600	1710
		875	---	---	---	---	---	452	4933	93.0					600	1751
56	380	---	---	---	---	---	---	199	5001	87.0	572	81.9	1.26	1397		
		420	---	---	---	---	---	221	5025	87.8					572	1436
		440	---	---	---	---	---	233	5057	88.6					572	1453
			505	---	---	---	---	266	5030	89.4					572	1498
		595	---	---	---	---	---	312	5007	90.9					572	1545
			700	---	---	---	---	368	5020	91.9					572	1590
		820	---	---	---	---	---	431	5019	93.0					572	1629
57	355	---	---	---	---	---	---	181	4869	86.2	525	92.1	1.45	1342		
		395	---	---	---	---	---	202	4883	87.4					525	1495
		415	---	---	---	---	---	213	4901	88.2					525	1539
			475	---	---	---	---	244	4905	89.4					525	1593
		555	---	---	---	---	---	285	4904	90.5					525	1651
			655	---	---	---	---	337	4913	91.7					525	1707
		765	---	---	---	---	---	394	4918	92.7					525	1754
58	325	---	---	---	---	---	---	162	4760	84.4	480	118	1.42	1235		
		365	---	---	---	---	---	181	4735	85.7					480	1379
		380	---	---	---	---	---	190	4775	86.1					480	1412
			440	---	---	---	---	219	4753	87.7					480	1462
		515	---	---	---	---	---	257	4765	89.2					480	1515
			610	---	---	---	---	304	4759	90.5					480	1566
		715	---	---	---	---	---	356	4755	91.6					480	1610
59	305	---	---	---	---	---	---	154	4822	83.7	460	131	1.66	1155		
		340	---	---	---	---	---	172	4831	85.0					460	1292
		360	---	---	---	---	---	181	4801	85.5					460	1361
			410	---	---	---	---	208	4845	87.0					460	1442
		485	---	---	---	---	---	244	4804	88.4					460	1497
			575	---	---	---	---	290	4816	90.1					460	1551
		675	---	---	---	---	---	340	4810	91.3					460	1596
60	285	---	---	---	---	---	---	159	5328	83.7	475	123	2.02	1011		
		320	---	---	---	---	---	178	5312	85.2					475	1034
		335	---	---	---	---	---	188	5359	86.0					475	1044
			385	---	---	---	---	216	5358	87.4					475	1069
		450	---	---	---	---	---	253	5369	88.8					475	1096
			535	---	---	---	---	300	5355	90.2					475	1121
		630	---	---	---	---	---	352	5335	91.5					475	1141

Nota (\*) - VENTILAZIONE SOLO L.O. / FAN ONLY SIDE COMMUTATOR

Nota (°) - Regolazione di campo / Field weakening



Potenza eccitazione Excitation power (w) 5200	Tipo Size MGL C 315 P
Cost. tempo eccitaz. Field time constant (ms) 800	Ventilazione Ventilation IC 06
Massa del motore Mass of the motor (Kg) 2650	
Momento d'inerzia rotore Rotor inertia moment (Kgm2) 12.0	

Avv.	Velocità nominale n/min a tensione nominale di armatura Rated speed (rev/min) at rated voltage							Potenza Power kW	Coppia vel. nomin. Torque at rated speed Nm	Rendimento Efficiency %	Circuito di armatura Armature circuit			Max giri Max. speed (°)
	400	440	460	520	600	700	810				Corrente Current Amp	Res. 115°C mOhm	Ind. mH	
61	261	---	---	---	---	---	---	137	5012	83.1	412	152	2.70	960
		293	---	---	---	---	---	153	4986	84.4	412			983
			310	---	---	---	---	161	4959	85.0	412			993
				355	---	---	---	185	4976	86.4	412			1018
					415	---	---	218	5016	88.2	412			1045
						495	---	259	4997	89.8	412			1069
							580	304	5005	91.1	412			1090
62	240	---	---	---	---	---	---	130	5173	81.3	400	171	2.61	877
		269	---	---	---	---	---	146	5183	83.0	400			898
			284	---	---	---	---	154	5178	83.7	400			907
				325	---	---	---	178	5230	85.6	400			930
					385	---	---	209	5184	87.1	400			954
						460	---	249	5169	88.9	400			977
							540	293	5181	90.4	400			995
63	223	---	---	---	---	---	---	118	5053	81.0	364	196	3.07	848
		251	---	---	---	---	---	132	5022	82.4	364			952
			264	---	---	---	---	139	5028	83.0	364			966
				305	---	---	---	161	5041	85.1	364			995
					360	---	---	190	5040	87.0	364			1024
						430	---	226	5019	88.7	364			1053
							505	265	5011	89.9	364			1076
64	208	---	---	---	---	---	---	107	4912	80.1	334	226	3.82	789
		234	---	---	---	---	---	120	4897	81.7	334			887
			246	---	---	---	---	126	4891	82.0	334			935
				285	---	---	---	146	4892	84.1	334			964
					335	---	---	173	4931	86.3	334			995
						400	---	206	4918	88.1	334			1023
							470	242	4917	89.5	334			1047
65	195	---	---	---	---	---	---	97.3	4765	79.0	308	254	4.59	739
		219	---	---	---	---	---	110	4796	81.2	308			832
			231	---	---	---	---	116	4795	81.9	308			878
				268	---	---	---	134	4775	83.7	308			935
					315	---	---	158	4790	85.5	308			966
						375	---	189	4813	87.7	308			995
							445	222	4764	89.0	308			1019

Nota (\*) - VENTILAZIONE SOLO L.O. / FAN ONLY SIDE COMMUTATOR

Nota (°) - Regolazione di campo / Field weakening



Potenza eccitazione Excitation power	(w)	5600	Tipo Size MGL C 315 X Ventilazione Ventilation IC 06
Cost. tempo eccitaz. Field time constant	(ms)	850	
Massa del motore Mass of the motor	(Kg)	2740	
Momento d'inerzia rotore Rotor inertia moment	(Kgm2)	12.8	

Avv.	Velocità nominale n/min a tensione nominale di armatura Rated speed (rev/min) at rated voltage							Potenza Power kW	Coppia vel.nomin. Torque at rated speed Nm	Rendimento Efficiency %	Circuito di armatura Armature circuit			Max giri Max. speed (°)
	400	440	460	520	600	700	810				Corrente Current Amp	Res. 115°C mOhm	Ind. mH	
40	1000	---	---	---	---	---	---	565	5395	94.2	1500	11.5	0.176	1980
		1105	---	---	---	---	---	624	5393	94.5	1500			2007
		---	1155	---	---	---	---	654	5407	94.8	1500			2019
		---	---	1315	---	---	---	743	5396	95.3	1500			2050
41	915	---	---	---	---	---	---	540	5636	93.8	1440	13.2	0.235	1776
		1010	---	---	---	---	---	597	5644	94.2	1440			1800
		---	1060	---	---	---	---	625	5630	94.4	1440			1811
		---	---	1205	---	---	---	711	5634	95.0	1440			1837
42	840	---	---	---	---	---	---	486	5525	92.7	1310	17.5	0.213	1681
		925	---	---	---	---	---	538	5554	93.3	1310			1705
		---	970	---	---	---	---	564	5552	93.6	1310			1715
		---	---	1105	---	---	---	641	5539	94.1	1310			1742
43	780	---	---	---	---	---	---	454	5558	92.6	1226	19.2	0.264	1590
		860	---	---	---	---	---	503	5585	93.2	1226			1612
		---	905	---	---	---	---	527	5561	93.4	1226			1622
		---	---	1030	---	---	---	600	5563	94.1	1226			1648
44	725	---	---	---	---	---	---	423	5572	92.4	1145	21.6	0.332	1502
		805	---	---	---	---	---	468	5552	92.9	1145			1524
		---	845	---	---	---	---	491	5549	93.2	1145			1534
		---	---	960	---	---	---	559	5560	93.9	1145			1558
45	680	---	---	---	---	---	---	387	5435	92.1	1050	24.5	0.398	1607
		755	---	---	---	---	---	428	5413	92.6	1050			1633
		---	790	---	---	---	---	449	5427	93.0	1050			1645
		---	---	900	---	---	---	511	5422	93.6	1050			1675
46	640	---	---	---	---	---	---	369	5506	91.9	1004	26.6	0.496	1442
		710	---	---	---	---	---	408	5487	92.4	1004			1465
		---	745	---	---	---	---	428	5486	92.7	1004			1475
		---	---	845	---	---	---	488	5515	93.5	1004			1501
		---	---	---	---	---	---	567	5497	94.1	1004			1528
		---	---	---	---	---	---	667	5515	94.9	1004			1554
		---	---	---	---	---	---	776	5509	95.4	1004			1575
		---	---	---	---	---	---	---	---	---	---			---

Nota (\*) - VENTILAZIONE SOLO L.O. / FAN ONLY SIDE COMMUTATOR

Nota (°) - Regolazione di campo / Field weakening



Potenza eccitazione Excitation power (w)	5600	Tipo	MGL C 315 X
Cost. tempo eccitaz. Field time constant (ms)	850	Size	MGL C 315 X
Massa del motore Mass of the motor (Kg)	2740	Ventilazione Ventilation	IC 06
Momento d'inerzia rotore Rotor inertia moment (Kgm2)	12.8		

Avv.	Velocità nominale n/min a tensione nominale di armatura Rated speed (rev/min) at rated voltage							Potenza Power kW	Coppia vel.nomin. Torque at rated speed Nm	Rendimento Efficiency %	Circuito di armatura Armature circuit			Max giri Max. speed (°)
	400	440	460	520	600	700	810				Corrente Current Amp	Res. 115°C mOhm	Ind. mH	
47	600	---	---	---	---	---	---	321	5109	90.8	884	35.3	0.434	1520
		665	---	---	---	---	---	356	5112	91.5	884			1548
		---	695	---	---	---	---	373	5125	91.7	884			1560
		---	---	795	---	---	---	425	5105	92.5	884			1591
		---	---	---	925	---	---	495	5110	93.3	884			1624
		---	---	---	---	1085	---	583	5131	94.2	884			1655
		---	---	---	---	---	1265	679	5126	94.8	884			1681
48	590	---	---	---	---	---	---	356	5762	90.8	980	31.3	0.462	1624
		655	---	---	---	---	---	395	5759	91.6	980			1656
		---	685	---	---	---	---	414	5771	91.8	980			1670
		---	---	785	---	---	---	473	5754	92.8	980			1706
		---	---	---	910	---	---	550	5772	93.5	980			1744
		---	---	---	---	1075	---	647	5747	94.3	980			1781
		---	---	---	---	---	1250	754	5760	95.0	980			1811
49	545	---	---	---	---	---	---	326	5712	90.6	900	35.6	0.613	1524
		605	---	---	---	---	---	361	5698	91.2	900			1555
		---	635	---	---	---	---	379	5700	91.5	900			1568
		---	---	725	---	---	---	433	5703	92.5	900			1603
		---	---	---	845	---	---	504	5696	93.3	900			1640
		---	---	---	---	990	---	593	5720	94.1	900			1675
		---	---	---	---	---	1155	691	5713	94.8	900			1704
50	500	---	---	---	---	---	---	292	5577	89.6	815	44.5	0.613	1474
		555	---	---	---	---	---	324	5575	90.4	815			1506
		---	585	---	---	---	---	340	5550	90.7	815			1520
		---	---	670	---	---	---	388	5530	91.6	815			1556
		---	---	---	780	---	---	453	5546	92.6	815			1593
		---	---	---	---	915	---	534	5573	93.6	815			1629
		---	---	---	---	---	1070	622	5551	94.2	815			1659
51	465	---	---	---	---	---	---	282	5791	89.2	790	47.8	0.765	1351
		520	---	---	---	---	---	313	5748	90.0	790			1380
		---	545	---	---	---	---	328	5747	90.3	790			1393
		---	---	625	---	---	---	375	5730	91.3	790			1425
		---	---	---	725	---	---	438	5769	92.4	790			1459
		---	---	---	---	855	---	516	5763	93.3	790			1491
		---	---	---	---	---	1000	602	5749	94.1	790			1518
52	440	---	---	---	---	---	---	258	5599	89.0	725	53.6	0.917	1305
		485	---	---	---	---	---	286	5631	89.7	725			1334
		---	510	---	---	---	---	301	5636	90.3	725			1346
		---	---	585	---	---	---	344	5615	91.2	725			1379
		---	---	---	680	---	---	401	5631	92.2	725			1413
		---	---	---	---	805	---	473	5611	93.2	725			1445
		---	---	---	---	---	935	552	5638	94.0	725			1473
53	410	---	---	---	---	---	---	235	5473	88.5	664	61.2	1.10	1387
		455	---	---	---	---	---	261	5478	89.3	664			1422
		---	480	---	---	---	---	274	5451	89.7	664			1437
		---	---	550	---	---	---	314	5452	90.9	664			1477
		---	---	---	640	---	---	366	5461	91.9	664			1519
		---	---	---	---	755	---	432	5464	92.9	664			1559
		---	---	---	---	---	880	504	5469	93.7	664			1593

Nota (\*) - VENTILAZIONE SOLO L.O. / FAN ONLY SIDE COMMUTATOR

Nota (°) - Regolazione di campo / Field weakening



Potenza eccitazione Excitation power (w) 5600	
Cost. tempo eccitaz. Field time constant (ms) 850	
Massa del motore Mass of the motor (Kg) 2740	
Momento d'inerzia rotore Rotor inertia moment (Kgm2) 12.8	
Tipo Size MGL C 315 X	
Ventilazione Ventilation IC 06	

Avv.	Velocità nominale n/min a tensione nominale di armatura Rated speed (rev/min) at rated voltage							Potenza Power kW	Coppia vel.nomin. Torque at rated speed Nm	Rendimento Efficiency %	Circuito di armatura Armature circuit			Max giri Max. speed (°)	
	400	440	460	520	600	700	810				Corrente Current Amp	Res. 115°C mOhm	Ind. mH		
54	395	---	---	---	---	---	---	230	5560	87.4	658	67.6	1.01	1444	
		440	---	---	---	---	---	256	5556	88.4	658			1483	
		460	---	---	---	---	---	---	269	5584	88.9			658	1500
			530	---	---	---	---	---	308	5549	90.0			658	1546
		620	---	---	---	---	---	---	360	5545	91.2			658	1594
			730	---	---	---	---	---	425	5560	92.3			658	1640
		855	---	---	---	---	---	---	497	5551	93.2			658	1679
55	365	---	---	---	---	---	---	207	5416	86.3	600	80.6	1.09	1381	
		405	---	---	---	---	---	231	5447	87.5	600			1424	
			425	---	---	---	---	---	243	5460	88.0			600	1442
		490	---	---	---	---	---	---	279	5437	89.4			600	1488
			570	---	---	---	---	---	326	5462	90.6			600	1536
		675	---	---	---	---	---	---	386	5461	91.9			600	1583
		790	---	---	---	---	---	---	451	5452	92.8			600	1622
56	340	---	---	---	---	---	---	197	5533	86.1	572	87.3	1.38	1286	
		375	---	---	---	---	---	220	5602	87.4	572			1323	
			395	---	---	---	---	---	231	5585	87.8			572	1339
		455	---	---	---	---	---	---	265	5562	89.1			572	1382
			535	---	---	---	---	---	310	5533	90.3			572	1427
		630	---	---	---	---	---	---	367	5563	91.7			572	1470
		735	---	---	---	---	---	---	429	5574	92.6			572	1507
57	315	---	---	---	---	---	---	180	5457	85.7	525	98.2	1.59	1203	
		355	---	---	---	---	---	201	5407	87.0	525			1342	
			370	---	---	---	---	---	211	5446	87.4			525	1411
		425	---	---	---	---	---	---	242	5437	88.6			525	1471
			500	---	---	---	---	---	284	5424	90.2			525	1526
		590	---	---	---	---	---	---	336	5438	91.4			525	1580
		690	---	---	---	---	---	---	393	5439	92.4			525	1625
58	291	---	---	---	---	---	---	160	5250	83.3	480	126	1.56	1105	
		325	---	---	---	---	---	179	5259	84.8	480			1236	
			345	---	---	---	---	---	189	5231	85.6			480	1302
		395	---	---	---	---	---	---	217	5246	86.9			480	1498
			465	---	---	---	---	---	255	5237	88.5			480	1696
		550	---	---	---	---	---	---	303	5261	90.2			480	1755
		645	---	---	---	---	---	---	355	5256	91.3			480	1805
59	272	---	---	---	---	---	---	152	5336	82.6	460	140	1.82	1033	
		305	---	---	---	---	---	170	5323	84.0	460			1157	
			320	---	---	---	---	---	179	5342	84.6			460	1219
		370	---	---	---	---	---	---	206	5317	86.1			460	1405
			435	---	---	---	---	---	243	5334	88.0			460	1653
		515	---	---	---	---	---	---	288	5340	89.4			460	1738
		605	---	---	---	---	---	---	338	5335	90.7			460	1790
60	255	---	---	---	---	---	---	158	5917	83.2	475	132	2.22	936	
		285	---	---	---	---	---	177	5931	84.7	475			958	
			300	---	---	---	---	---	186	5921	85.1			475	967
		345	---	---	---	---	---	---	214	5923	86.6			475	992
			405	---	---	---	---	---	252	5942	88.4			475	1018
		480	---	---	---	---	---	---	299	5948	89.9			475	1042
		565	---	---	---	---	---	---	351	5932	91.2			475	1062

Nota (\*) - VENTILAZIONE SOLO L.O. / FAN ONLY SIDE COMMUTATOR

Nota (°) - Regolazione di campo / Field weakening



Potenza eccitazione Excitation power (w) 5600	Tipo Size MGL C 315 X
Cost. tempo eccitaz. Field time constant (ms) 850	Ventilazione Ventilation IC 06
Massa del motore Mass of the motor (Kg) 2740	
Momento d'inerzia rotore Rotor inertia moment (Kgm2) 12.8	

Avv.	Velocità nominale n/min a tensione nominale di armatura Rated speed (rev/min) at rated voltage							Potenza Power kW	Coppia vel. nomin. Torque at rated speed Nm	Rendimento Efficiency %	Circuito di armatura Armature circuit			Max giri Max. speed (°)
	400	440	460	520	600	700	810				Corrente Current Amp	Res. 115°C mOhm	Ind. mH	
61	234	---	---	---	---	---	---	135	5509	81.9	412	162	2.96	886
		262	---	---	---	---	---	151	5504	83.3	412			
		276	---	---	---	---	---	159	5501	83.9	412			
			320	---	---	---	---	184	5491	85.9	412			
		375	---	---	---	---	---	216	5500	87.4	412			
			445	---	---	---	---	257	5515	89.1	412			
				525	---	---	---	---	302	5493	90.5			
62	214	---	---	---	---	---	---	129	5756	80.6	400	183	2.87	808
		241	---	---	---	---	---	144	5706	81.8	400			
		254	---	---	---	---	---	152	5715	82.6	400			
			293	---	---	---	---	176	5736	84.6	400			
		345	---	---	---	---	---	208	5757	86.7	400			
			410	---	---	---	---	247	5753	88.2	400			
				485	---	---	---	---	291	5730	89.8			
63	199	---	---	---	---	---	---	116	5566	79.7	364	209	3.36	756
		224	---	---	---	---	---	130	5542	81.2	364			
		236	---	---	---	---	---	138	5584	82.4	364			
			273	---	---	---	---	159	5562	84.0	364			
		325	---	---	---	---	---	188	5524	86.1	364			
			385	---	---	---	---	224	5556	87.9	364			
				455	---	---	---	---	264	5541	89.5			
64	185	---	---	---	---	---	---	105	5420	78.6	334	241	4.19	703
		208	---	---	---	---	---	118	5417	80.3	334			
		220	---	---	---	---	---	125	5426	81.4	334			
			255	---	---	---	---	145	5430	83.5	334			
		300	---	---	---	---	---	171	5443	85.3	334			
			360	---	---	---	---	204	5411	87.3	334			
				425	---	---	---	---	240	5393	88.7			
65	173	---	---	---	---	---	---	95.8	5288	77.8	308	271	5.04	658
		195	---	---	---	---	---	108	5289	79.7	308			
		206	---	---	---	---	---	114	5285	80.5	308			
			239	---	---	---	---	132	5274	82.4	308			
		283	---	---	---	---	---	157	5298	85.0	308			
			340	---	---	---	---	187	5252	86.7	308			
				400	---	---	---	---	221	5276	88.6			

Nota (\*) - VENTILAZIONE SOLO L.O. / FAN ONLY SIDE COMMUTATOR

Nota (°) - Regolazione di campo / Field weakening



Potenza eccitazione  
Excitation power (w) 5800  
Cost. tempo eccitaz.  
Field time constant (ms) 870  
Massa del motore  
Mass of the motor (Kg) 2930  
Momento d'inerzia rotore  
Rotor inertia moment (Kgm2) 14.22

Tipo  
Size MGL C 315 X2  
Ventilazione  
Ventilation IC 06

Avv.	Velocità nominale n/min a tensione nominale di armatura Rated speed (rev/min) at rated voltage							Potenza Power kW	Coppia vel. nomin. Torque at rated speed Nm	Rendimento Efficiency %	Circuito di armatura Armature circuit			Max giri Max. speed (°)	
	400	440	460	520	600	700	810				Corrente Current Amp	Res. 115°C mOhm	Ind. mH		
40	945	---	---	---	---	---	---	557	5629	92.8	1500	13.8	0.20	1723	
								616	5629	93.3	1500				
								646	5634	93.6	1500				
								735	5638	94.2	1500				
41	865	---	---	---	---	---	---	532	5873	92.4	1440	15.1	0.26	1545	
								589	5859	93.0	1440				
								617	5863	93.1	1440				
								702	5855	93.8	1440				
42	800	---	---	---	---	---	---	483	5765	92.2	1310	17.4	0.24	1462	
								534	5762	92.6	1310				
								560	5750	92.9	1310				
								638	5775	93.7	1310				
43	735	---	---	---	---	---	---	448	5821	91.4	1226	22.0	0.29	1383	
								496	5812	91.9	1226				
								521	5819	92.4	1226				
								593	5808	93.0	1226				
44	690	---	---	---	---	---	---	419	5799	91.5	1145	23.0	0.37	1307	
								464	5792	92.1	1145				
								486	5801	92.3	1145				
								554	5782	93.0	1145				
45	645	---	---	---	---	---	---	382	5656	91.0	1050	26.5	0.44	1398	
								423	5649	91.6	1050				
								444	5653	91.9	1050				
								506	5651	92.7	1050				
46	600	---	---	---	---	---	---	360	5730	89.6	1004	34.1	0.55	1255	
								399	5730	90.3	1004				
								419	5757	90.7	1004				
								478	5742	91.6	1004				
								558	5730	92.6	1004				1329
								558	5730	92.6	1004				1329
								656	5721	93.3	1004				1352
								765	5730	94.1	1004				1370

Nota (\*) - VENTILAZIONE SOLO L.O. / FAN ONLY SIDE COMMUTATOR

Nota (°) - Regolazione di campo / Field weakening





Potenza eccitazione Excitation power (w)	5800	Tipo	
Cost. tempo eccitaz. Field time constant (ms)	870	Size	MGL C 315 X2
Massa del motore Mass of the motor (Kg)	2930	Ventilazione Ventilation	IC 06
Momento d'inerzia rotore Rotor inertia moment (Kgm2)	14.22		

Avv.	Velocità nominale n/min a tensione nominale di armatura Rated speed (rev/min) at rated voltage							Potenza Power kW	Coppia vel. nomin. Torque at rated speed Nm	Rendimento Efficiency %	Circuito di armatura Armature circuit			Max giri Max. speed (°)
	400	440	460	520	600	700	810				Corrente Current Amp	Res. 115°C mOhm	Ind. mH	
47	585	---	---	---	---	---	---	325	5305	91.9	884	26.4	0.48	1322
		645	---	---	---	---	---	360	5330	92.6				1347
		---	675	---	---	---	---	378	5348	93.0				1357
		---	---	770	---	---	---	430	5333	93.5				1384
		---	---	---	895	---	---	499	5324	94.1				1413
		---	---	---	---	1050	---	586	5329	94.7				1440
		---	---	---	---	---	1220	682	5338	95.2				1462
		---	---	---	---	---	---	---	---	---				---
48	555	---	---	---	---	---	---	350	6022	89.3	980	36.4	0.51	1413
		620	---	---	---	---	---	388	5976	90.0				1441
		---	650	---	---	---	---	408	5994	90.5				1453
		---	---	740	---	---	---	466	6013	91.4				1484
		---	---	---	865	---	---	543	5995	92.3				1517
		---	---	---	---	1020	---	640	5992	93.3				1549
		---	---	---	---	---	1180	746	6037	94.0				1576
		---	---	---	---	---	---	---	---	---				---
49	515	---	---	---	---	---	---	321	5952	89.2	900	39.3	0.68	1326
		570	---	---	---	---	---	357	5981	90.2				1353
		---	600	---	---	---	---	375	5968	90.6				1364
		---	---	685	---	---	---	428	5967	91.5				1395
		---	---	---	800	---	---	499	5956	92.4				1427
		---	---	---	---	940	---	587	5963	93.2				1457
		---	---	---	---	---	1100	685	5947	94.0				1482
		---	---	---	---	---	---	---	---	---				---
50	475	---	---	---	---	---	---	289	5810	88.7	815	46.1	0.68	1282
		530	---	---	---	---	---	321	5784	89.5				1310
		---	555	---	---	---	---	337	5798	89.9				1322
		---	---	635	---	---	---	385	5790	90.8				1354
		---	---	---	740	---	---	450	5807	92.0				1386
		---	---	---	---	875	---	530	5784	92.9				1417
		---	---	---	---	---	1020	618	5786	93.6				1443
		---	---	---	---	---	---	---	---	---				---
51	445	---	---	---	---	---	---	277	5944	87.7	790	51.1	0.85	1175
		495	---	---	---	---	---	309	5961	88.9				1201
		---	510	---	---	---	---	324	6067	89.2				1212
		---	---	590	---	---	---	371	6005	90.3				1240
		---	---	---	690	---	---	433	5993	91.4				1269
		---	---	---	---	815	---	510	5976	92.2				1297
		---	---	---	---	---	950	596	5991	93.1				1321
		---	---	---	---	---	---	---	---	---				---
52	415	---	---	---	---	---	---	254	5845	87.6	725	58.1	1.02	1135
		460	---	---	---	---	---	282	5854	88.4				1161
		---	485	---	---	---	---	296	5828	88.8				1171
		---	---	555	---	---	---	339	5833	89.9				1200
		---	---	---	640	---	---	396	5909	91.0				1229
		---	---	---	---	765	---	468	5842	92.2				1257
		---	---	---	---	---	890	546	5858	93.0				1282
		---	---	---	---	---	---	---	---	---				---
53	385	---	---	---	---	---	---	227	5630	85.5	664	66.9	1.22	1207
		430	---	---	---	---	---	252	5596	86.3				1237
		---	455	---	---	---	---	265	5562	86.8				1250
		---	---	520	---	---	---	304	5583	88.0				1285
		---	---	---	605	---	---	355	5603	89.1				1322
		---	---	---	---	715	---	419	5596	90.1				1356
		---	---	---	---	---	835	489	5592	90.9				1386
		---	---	---	---	---	---	---	---	---				---

Nota (\*) - VENTILAZIONE SOLO L.O. / FAN ONLY SIDE COMMUTATOR

Nota (°) - Regolazione di campo / Field weakening



Potenza eccitazione Excitation power (w) 5800	Tipo Size MGL C 315 X2
Cost. tempo eccitaz. Field time constant (ms) 870	Ventilazione Ventilation IC 06
Massa del motore Mass of the motor (Kg) 2930	
Momento d'inerzia rotore Rotor inertia moment (Kgm2) 14.22	

Avv.	Velocità nominale n/min a tensione nominale di armatura Rated speed (rev/min) at rated voltage							Potenza Power kW	Coppia vel. nomin. Torque at rated speed Nm	Rendimento Efficiency %	Circuito di armatura Armature circuit			Max giri Max. speed (°)	
	400	440	460	520	600	700	810				Corrente Current Amp	Res. 115°C mOhm	Ind. mH		
54	375	---	---	---	---	---	---	228	5806	86.6	658	68.4	1.12	1256	
		420	---	---	---	---	---	254	5775	87.7	658			1290	
		440	---	---	---	---	---	---	267	5795	88.2			658	1305
			505	---	---	---	---	---	306	5786	89.4			658	1345
		590	---	---	---	---	---	---	358	5794	90.7			658	1387
			---	---	---	---	---	695	422	5798	91.6			658	1427
			---	---	---	---	---	815	493	5776	92.5			658	1461
55	340	---	---	---	---	---	---	203	5701	84.6	600	88.2	1.21	1201	
		380	---	---	---	---	---	227	5704	86.0	600			1239	
		400	---	---	---	---	---	---	238	5682	86.2			600	1255
			460	---	---	---	---	---	274	5688	87.8			600	1295
		540	---	---	---	---	---	---	321	5677	89.2			600	1336
			---	---	---	---	640	---	380	5670	90.5			600	1377
			---	---	---	---	750	---	444	5653	91.4			600	1411
56	320	---	---	---	---	---	---	194	5789	84.8	572	93.8	1.53	1119	
		355	---	---	---	---	---	216	5810	85.8	572			1151	
		375	---	---	---	---	---	---	227	5781	86.3			572	1165
			430	---	---	---	---	---	261	5796	87.7			572	1202
		505	---	---	---	---	---	---	306	5786	89.2			572	1241
			---	---	---	---	600	---	363	5777	90.7			572	1279
			---	---	---	---	700	---	424	5784	91.5			572	1311
57	295	---	---	---	---	---	---	176	5697	83.8	525	108.8	1.77	1047	
		330	---	---	---	---	---	196	5672	84.8	525			1168	
		350	---	---	---	---	---	---	207	5648	85.7			525	1228
			400	---	---	---	---	---	238	5682	87.2			525	1280
		470	---	---	---	---	---	---	279	5669	88.6			525	1328
			---	---	---	---	560	---	330	5627	89.8			525	1375
			---	---	---	---	655	---	387	5642	91.0			525	1414
58	270	---	---	---	---	---	---	156	5517	81.3	480	139.9	1.73	961	
		305	---	---	---	---	---	175	5479	82.9	480			1075	
		320	---	---	---	---	---	---	184	5491	83.3			480	1133
			370	---	---	---	---	---	212	5471	84.9			480	1303
		435	---	---	---	---	---	---	250	5488	86.8			480	1476
			---	---	---	---	520	---	297	5454	88.4			480	1527
			---	---	---	---	610	---	349	5463	89.8			480	1570
59	255	---	---	---	---	---	---	147	5505	79.9	460	158.4	2.02	899	
		285	---	---	---	---	---	165	5529	81.5	460			1007	
		300	---	---	---	---	---	---	174	5539	82.2			460	1061
			345	---	---	---	---	---	201	5564	84.0			460	1222
		410	---	---	---	---	---	---	238	5543	86.2			460	1438
			---	---	---	---	485	---	283	5572	87.9			460	1512
			---	---	---	---	570	---	333	5579	89.4			460	1557
60	240	---	---	---	---	---	---	154	6127	81.1	475	145.4	2.47	814	
		265	---	---	---	---	---	172	6198	82.3	475			833	
		280	---	---	---	---	---	---	182	6207	83.3			475	841
			325	---	---	---	---	---	210	6170	85.0			475	863
		380	---	---	---	---	---	---	247	6207	86.7			475	886
			---	---	---	---	455	---	294	6170	88.4			475	907
			---	---	---	---	535	---	345	6158	89.7			475	924

Nota (\*) - VENTILAZIONE SOLO L.O. / FAN ONLY SIDE COMMUTATOR

Nota (°) - Regolazione di campo / Field weakening



Potenza eccitazione Excitation power (w)	5800	Tipo	
Cost. tempo eccitaz. Field time constant (ms)	870	Size	MGL C 315 X2
Massa del motore Mass of the motor (Kg)	2930	Ventilazione Ventilation	IC 06
Momento d'inerzia rotore Rotor inertia moment (Kgm2)	14.22		

Avv.	Velocità nominale n/min a tensione nominale di armatura Rated speed (rev/min) at rated voltage							Potenza Power kW	Coppia vel. nomin. Torque at rated speed Nm	Rendimento Efficiency %	Circuito di armatura Armature circuit			Max giri Max. speed (°)
	400	440	460	520	600	700	810				Corrente Current Amp	Res. 115°C mOhm	Ind. mH	
61	225	---	---	---	---	---	---	134	5687	81.3	412	163.1	3.29	771
		250	---	---	---	---	---	150	5730	82.7	412			790
		265	---	---	---	---	---	158	5694	83.4	412			798
			305	---	---	---	---	182	5698	85.0	412			820
		355	---	---	---	---	---	215	5783	87.0	412			841
			425	---	---	---	---	255	5730	88.4	412			862
		500	---	---	---	---	---	300	5730	89.9	412			880
62	200	---	---	---	---	---	---	125	5968	78.1	400	201.8	3.19	703
		225	---	---	---	---	---	141	5984	80.1	400			720
		235	---	---	---	---	---	149	6055	81.0	400			728
			275	---	---	---	---	172	5973	82.7	400			747
		325	---	---	---	---	---	204	5994	85.0	400			767
			390	---	---	---	---	243	5950	86.8	400			786
		460	---	---	---	---	---	287	5958	88.6	400			802
63	185	---	---	---	---	---	---	112	5781	76.9	364	232.2	3.73	658
		210	---	---	---	---	---	127	5775	79.3	364			740
		220	---	---	---	---	---	134	5816	80.0	364			775
			255	---	---	---	---	156	5842	82.4	364			800
		305	---	---	---	---	---	184	5761	84.2	364			825
			360	---	---	---	---	220	5836	86.3	364			848
		430	---	---	---	---	---	260	5774	88.2	364			867
64	170	---	---	---	---	---	---	101	5673	75.6	334	270.7	4.66	612
		195	---	---	---	---	---	115	5632	78.3	334			689
		205	---	---	---	---	---	121	5636	78.8	334			727
			240	---	---	---	---	141	5610	81.2	334			774
		285	---	---	---	---	---	167	5596	83.3	334			800
			340	---	---	---	---	200	5617	85.5	334			823
		400	---	---	---	---	---	237	5658	87.6	334			843
65	160	---	---	---	---	---	---	91.3	5449	74.1	308	312.2	5.6	572
		180	---	---	---	---	---	103	5464	76.0	308			646
		190	---	---	---	---	---	110	5529	77.6	308			682
			220	---	---	---	---	128	5556	79.9	308			750
		265	---	---	---	---	---	152	5477	82.3	308			775
			315	---	---	---	---	182	5517	84.4	308			800
		375	---	---	---	---	---	215	5475	86.2	308			820

Nota (\*) - VENTILAZIONE SOLO L.O. / FAN ONLY SIDE COMMUTATOR

Nota (°) - Regolazione di campo / Field weakening



Potenza eccitazione Excitation power	(w)	5000	Tipo Size MGL C 400 K Ventilazione Ventilation IC 06
Cost. tempo eccitaz. Field time constant	(ms)	1050	
Massa del motore Mass of the motor	(Kg)	3150	
Momento d'inerzia rotore Rotor inertia moment	(Kgm2)	30	

Avv.	Velocità nominale n/min a tensione nominale di armatura Rated speed (rev/min) at rated voltage							Potenza Power kW	Coppia vel.nomin. Torque at rated speed Nm	Rendimento Efficiency %	Circuito di armatura Armature circuit			Max giri Max. speed (°)	
	400	440	460	520	600	700	810				Corrente Current Amp	Res. 115°C mOhm	Ind. mH		
39	1330	---	---	---	---	---	---	674	4839	93.6	1800	7.38	0.155	2200	*
		1465	---	---	---	---	---	745	4856	94.1	1800			2200	
		---	1535	---	---	---	---	780	4852	94.2	1800			2200	
		---	---	1745	---	---	---	885	4843	94.6	1800			2200	
40	1220	---	---	---	---	---	---	638	4994	92.9	1716	9.64	0.130	2096	*
		1350	---	---	---	---	---	705	4987	93.4	1716			2121	
		---	1410	---	---	---	---	738	4998	93.5	1716			2132	
		---	---	1605	---	---	---	839	4992	94.0	1716			2159	
41	1135	---	---	---	---	---	---	601	5057	92.9	1618	10.5	0.168	2017	
		1255	---	---	---	---	---	664	5052	93.3	1618			2041	
		---	1315	---	---	---	---	695	5047	93.4	1618			2052	
		---	---	1490	---	---	---	790	5063	93.9	1618			2080	
42	1060	---	---	---	---	---	---	555	5000	92.5	1500	12.5	0.212	2044	
		1170	---	---	---	---	---	614	5011	93.0	1500			2071	
		---	1225	---	---	---	---	643	5012	93.2	1500			2083	
		---	---	1395	---	---	---	731	5004	93.7	1500			2114	
43	985	---	---	---	---	---	---	544	5274	91.9	1480	14.7	0.202	1789	
		1090	---	---	---	---	---	602	5274	92.4	1480			1812	
		---	1145	---	---	---	---	631	5263	92.7	1480			1822	
		---	---	1300	---	---	---	718	5274	93.3	1480			1847	
44	930	---	---	---	---	---	---	501	5144	91.6	1367	16.4	0.247	1731	
		1025	---	---	---	---	---	555	5171	92.3	1367			1754	
		---	1075	---	---	---	---	582	5170	92.6	1367			1764	
		---	---	1225	---	---	---	662	5161	93.1	1367			1789	
45	880	---	---	---	---	---	---	485	5263	91.9	1320	16.8	0.289	1688	
		970	---	---	---	---	---	536	5277	92.3	1320			1711	
		---	1020	---	---	---	---	562	5262	92.6	1320			1751	
		---	---	1160	---	---	---	639	5260	93.1	1320			1746	
		---	---	---	---	---	---	743	5275	93.8	1320			1773	
		---	---	---	---	---	---	872	5270	94.4	1320			1798	
		---	---	---	---	---	1580	1003	5220	94.7	1307			1837	
		---	---	---	---	---	---	---	---	---	---			---	

Nota (\*) - VENTILAZIONE SOLO L.O. / FAN ONLY SIDE COMMUTATOR

Nota (°) - Regolazione di campo / Field weakening



Potenza eccitazione Excitation power	(w)	5000	Tipo Size Ventilazione Ventilation	MGL C 400 K  IC 06
Cost. tempo eccitaz. Field time constant	(ms)	1050		
Massa del motore Mass of the motor	(Kg)	3150		
Momento d'inerzia rotore Rotor inertia moment	(Kgm2)	30		

Avv.	Velocità nominale n/min a tensione nominale di armatura Rated speed (rev/min) at rated voltage							Potenza Power kW	Coppia vel.nomin. Torque at rated speed Nm	Rendimento Efficiency %	Circuito di armatura Armature circuit			Max giri Max. speed (°)
	400	440	460	520	600	700	810				Corrente Current Amp	Res. 115°C mOhm	Ind. mH	
46	830	---	---	---	---	---	---	447	5143	91.3	1224	19.3	0.339	1639
		920	---	---	---	---	---	495	5138	91.9	1224			1661
		---	965	---	---	---	---	519	5136	92.2	1224			1671
		---	---	1095	---	---	---	591	5154	92.9	1224			1697
		---	---	---	1275	---	---	687	5145	93.5	1224			1723
		---	---	---	---	1495	---	806	5148	94.1	1224			1748
		---	---	---	---	---	1740	938	5148	94.6	1224			1769
		---	---	---	---	---	---	---	---	---	---			---
47	785	---	---	---	---	---	---	409	4975	90.5	1130	23.9	0.326	1753
		865	---	---	---	---	---	453	5001	91.1	1130			1781
		---	910	---	---	---	---	475	4985	91.4	1130			1793
		---	---	1035	---	---	---	542	5001	92.2	1130			1825
		---	---	---	1205	---	---	630	4993	92.9	1130			1857
		---	---	---	---	1415	---	740	4994	93.6	1130			1888
		---	---	---	---	---	1650	861	4983	94.1	1130			1914
		---	---	---	---	---	---	---	---	---	---			---
48	745	---	---	---	---	---	---	401	5140	90.6	1106	24.3	0.361	1695
		825	---	---	---	---	---	444	5139	91.2	1106			1722
		---	865	---	---	---	---	466	5145	91.6	1106			1734
		---	---	990	---	---	---	530	5112	92.2	1106			1765
		---	---	---	1150	---	---	617	5123	93.0	1106			1797
		---	---	---	---	1350	---	725	5128	93.6	1106			1827
		---	---	---	---	---	1570	844	5134	94.2	1106			1853
		---	---	---	---	---	---	---	---	---	---			---
49	710	---	---	---	---	---	---	360	4842	90.0	1000	28.9	0.423	1797
		785	---	---	---	---	---	399	4854	90.7	1000			1830
		---	825	---	---	---	---	419	4850	91.1	1000			1844
		---	---	940	---	---	---	477	4846	91.7	1000			1881
		---	---	---	1095	---	---	555	4840	92.5	1000			1919
		---	---	---	---	1285	---	653	4853	93.3	1000			1956
		---	---	---	---	---	1500	760	4838	93.8	1000			1986
		---	---	---	---	---	---	---	---	---	---			---
50	685	---	---	---	---	---	---	375	5228	90.1	1040	27.8	0.466	1842
		760	---	---	---	---	---	416	5227	90.9	1040			1878
		---	800	---	---	---	---	436	5204	91.1	1040			1893
		---	---	910	---	---	---	497	5215	91.9	1040			1933
		---	---	---	1060	---	---	578	5207	92.6	1040			1976
		---	---	---	---	1245	---	680	5216	93.4	1040			2016
		---	---	---	---	---	1450	792	5216	94.0	1040			2049
		---	---	---	---	---	---	---	---	---	---			---
51	645	---	---	---	---	---	---	365	5404	90.3	1010	28.3	0.609	1643
		715	---	---	---	---	---	404	5396	90.9	1010			1673
		---	750	---	---	---	---	424	5399	91.3	1010			1686
		---	---	855	---	---	---	483	5395	92.0	1010			1720
		---	---	---	995	---	---	562	5394	92.7	1010			1755
		---	---	---	---	1170	---	661	5395	93.5	1010			1789
		---	---	---	---	---	1360	770	5407	94.1	1010			1817
		---	---	---	---	---	---	---	---	---	---			---
52	600	---	---	---	---	---	---	330	5252	89.3	924	35.2	0.581	1597
		670	---	---	---	---	---	366	5217	90.0	924			1627
		---	700	---	---	---	---	384	5239	90.3	924			1641
		---	---	800	---	---	---	438	5228	91.2	924			1676
		---	---	---	930	---	---	511	5247	92.2	924			1712
		---	---	---	---	1095	---	601	5241	92.9	924			1746
		---	---	---	---	---	1280	700	5222	93.5	924			1775
		---	---	---	---	---	---	---	---	---	---			---

Nota (\*) - VENTILAZIONE SOLO L.O. / FAN ONLY SIDE COMMUTATOR

Nota (°) - Regolazione di campo / Field weakening



Potenza eccitazione Excitation power (w) 5000	
Cost. tempo eccitaz. Field time constant (ms) 1050	
Massa del motore Mass of the motor (Kg) 3150	
Momento d'inerzia rotore Rotor inertia moment (Kgm2) 30	
Tipo Size MGL C 400 K	
Ventilazione Ventilation IC 06	

Avv.	Velocità nominale n/min a tensione nominale di armatura Rated speed (rev/min) at rated voltage							Potenza Power kW	Coppia vel.nomin. Torque at rated speed Nm	Rendimento Efficiency %	Circuito di armatura Armature circuit			Max giri Max. speed (°)
	400	440	460	520	600	700	810				Corrente Current Amp	Res. 115°C mOhm	Ind. mH	
53	565	---	---	---	---	---	---	321	5425	88.8	904	38.4	0.562	1536
		630	---	---	---	---	---	356	5396	89.5	904			1566
		660	---	---	---	---	---	374	5411	89.9	904			1579
		755	---	---	---	---	---	427	5401	90.8	904			1614
		880	---	---	---	---	---	498	5404	91.8	904			1649
		1035	---	---	---	---	---	586	5407	92.6	904			1683
		1205	---	---	---	---	---	683	5413	93.3	904			1712
		54	535	---	---	---	---	---	---	294	5248			88.0
595	---			---	---	---	---	327	5248	89.0	835	1522		
620	---			---	---	---	---	343	5283	89.3	835	1536		
710	---			---	---	---	---	392	5272	90.3	835	1570		
830	---			---	---	---	---	458	5269	91.4	835	1606		
975	---			---	---	---	---	539	5279	92.2	835	1641		
1140	---			---	---	---	---	629	5269	93.0	835	1669		
55	505			---	---	---	---	---	---	271	5125	88.0	770	48.9
		565	---	---	---	---	---	301	5087	88.8	770	1619		
		590	---	---	---	---	---	316	5115	89.2	770	1635		
		675	---	---	---	---	---	361	5107	90.2	770	1676		
		790	---	---	---	---	---	421	5089	91.1	770	1720		
		930	---	---	---	---	---	497	5103	92.2	770	1761		
		1085	---	---	---	---	---	579	5096	92.8	770	1796		
		56	500	---	---	---	---	---	---	269	5138	87.8	766	
560	---			---	---	---	---	299	5099	88.7	766	1789		
585	---			---	---	---	---	314	5126	89.1	766	1809		
670	---			---	---	---	---	359	5117	90.1	766	1860		
780	---			---	---	---	---	419	5130	91.2	766	1915		
920	---			---	---	---	---	494	5128	92.1	766	1967		
1075	---			---	---	---	---	576	5117	92.8	766	2011		
57	470			---	---	---	---	---	---	261	5303	87.5	746	53.2
		520	---	---	---	---	---	290	5326	88.3	746	1594		
		550	---	---	---	---	---	305	5296	88.9	746	1611		
		625	---	---	---	---	---	349	5332	90.0	746	1655		
		730	---	---	---	---	---	407	5324	90.9	746	1701		
		865	---	---	---	---	---	480	5299	91.9	746	1745		
		1005	---	---	---	---	---	560	5321	92.7	746	1782		
		58	435	---	---	---	---	---	---	236	5181	86.4	683	
485	---			---	---	---	---	262	5159	87.2	683	1545		
510	---			---	---	---	---	276	5168	87.8	683	1562		
585	---			---	---	---	---	316	5158	89.0	683	1607		
685	---			---	---	---	---	369	5144	90.0	683	1654		
805	---			---	---	---	---	436	5172	91.2	683	1699		
945	---			---	---	---	---	509	5144	92.0	683	1736		
59	410			---	---	---	---	---	---	227	5287	86.0	660	68.8
		460	---	---	---	---	---	253	5252	87.1	660	1500		
		480	---	---	---	---	---	266	5292	87.6	660	1517		
		550	---	---	---	---	---	305	5296	88.9	660	1562		
		645	---	---	---	---	---	356	5271	89.9	660	1609		
		765	---	---	---	---	---	421	5255	91.1	660	1654		
		890	---	---	---	---	---	492	5279	92.0	660	1692		

Nota (\*) - VENTILAZIONE SOLO L.O. / FAN ONLY SIDE COMMUTATOR

Nota (°) - Regolazione di campo / Field weakening



Potenza eccitazione Excitation power	(w)	5000	Tipo Size Ventilazione Ventilation	MGL C 400 K  IC 06
Cost. tempo eccitaz. Field time constant	(ms)	1050		
Massa del motore Mass of the motor	(Kg)	3150		
Momento d'inerzia rotore Rotor inertia moment	(Kgm2)	30		

Avv.	Velocità nominale n/min a tensione nominale di armatura Rated speed (rev/min) at rated voltage							Potenza Power kW	Coppia vel.nomin. Torque at rated speed Nm	Rendimento Efficiency %	Circuito di armatura Armature circuit			Max giri Max. speed (°)
	400	440	460	520	600	700	810				Corrente Current Amp	Res. 115°C mOhm	Ind. mH	
60	390	---	---	---	---	---	---	209	5117	85.4	612	78.3	1.35	1412
		435	---	---	---	---	---	233	5115	86.5	612			1451
		455	---	---	---	---	---	245	5142	87.0	612			1468
		---	520	---	---	---	---	281	5160	88.3	612			1512
		---	---	610	---	---	---	329	5150	89.6	612			1559
		---	---	---	---	720	---	389	5159	90.8	612			1604
		---	---	---	---	---	845	454	5131	91.6	612			1642
		---	---	---	---	---	---	---	---	---	---			---
61	365	---	---	---	---	---	---	191	4997	84.7	564	90.3	1.61	1391
		410	---	---	---	---	---	213	4961	85.8	564			1504
		---	430	---	---	---	---	224	4975	86.3	564			1524
		---	---	495	---	---	---	257	4958	87.6	564			1575
		---	---	---	575	---	---	301	4999	88.9	564			1630
		---	---	---	---	685	---	356	4963	90.2	564			1682
		---	---	---	---	---	800	417	4978	91.3	564			1726
		---	---	---	---	---	---	---	---	---	---			---
62	345	---	---	---	---	---	---	185	5121	83.9	551	99.3	1.50	1312
		385	---	---	---	---	---	206	5110	85.0	551			1465
		---	405	---	---	---	---	217	5117	85.6	551			1488
		---	---	465	---	---	---	249	5114	86.9	551			1540
		---	---	---	545	---	---	292	5116	88.3	551			1595
		---	---	---	---	645	---	346	5123	89.7	551			1649
		---	---	---	---	---	760	405	5089	90.7	551			1694
		---	---	---	---	---	---	---	---	---	---			---
63	320	---	---	---	---	---	---	176	5252	83.0	530	108	1.76	1102
		360	---	---	---	---	---	197	5226	84.5	530			1126
		---	380	---	---	---	---	207	5202	84.9	530			1136
		---	---	435	---	---	---	239	5247	86.7	530			1163
		---	---	---	510	---	---	280	5243	88.1	530			1191
		---	---	---	---	605	---	332	5240	89.5	530			1217
		---	---	---	---	---	710	389	5232	90.6	530			1238
		---	---	---	---	---	---	---	---	---	---			---
64	305	---	---	---	---	---	---	170	5323	83.2	511	111	2.26	989
		340	---	---	---	---	---	190	5336	84.5	511			1009
		---	355	---	---	---	---	200	5380	85.1	511			1018
		---	---	410	---	---	---	230	5357	86.6	511			1041
		---	---	---	480	---	---	270	5372	88.1	511			1064
		---	---	---	---	570	---	320	5361	89.5	511			1086
		---	---	---	---	---	665	375	5385	90.6	511			1104
		---	---	---	---	---	---	---	---	---	---			---
65	278	---	---	---	---	---	---	152	5221	81.2	468	140	2.27	956
		310	---	---	---	---	---	170	5237	82.6	468			977
		---	330	---	---	---	---	180	5209	83.6	468			986
		---	---	380	---	---	---	207	5202	85.1	468			1010
		---	---	---	445	---	---	244	5236	86.9	468			1034
		---	---	---	---	530	---	289	5207	88.2	468			1057
		---	---	---	---	---	620	340	5237	89.7	468			1076
		---	---	---	---	---	---	---	---	---	---			---
66	259	---	---	---	---	---	---	146	5383	80.2	455	153	2.29	921
		291	---	---	---	---	---	164	5382	81.9	455			943
		---	305	---	---	---	---	173	5417	82.7	455			952
		---	---	355	---	---	---	199	5353	84.1	455			976
		---	---	---	415	---	---	235	5407	86.1	455			1000
		---	---	---	---	495	---	279	5382	87.6	455			1023
		---	---	---	---	---	585	328	5354	89.0	455			1042
		---	---	---	---	---	---	---	---	---	---			---

Nota (\*) - VENTILAZIONE SOLO L.O. / FAN ONLY SIDE COMMUTATOR

Nota (°) - Regolazione di campo / Field weakening





Potenza eccitazione  
Excitation power (w) 5000  
Cost. tempo eccitaz.  
Field time constant (ms) 1050  
Massa del motore  
Mass of the motor (Kg) 3150  
Momento d'inerzia rotore  
Rotor inertia moment (Kgm2) 30

Tipo  
Size MGL C 400 K  
Ventilazione  
Ventilation IC 06

Avv.	Velocità nominale n/min a tensione nominale di armatura Rated speed (rev/min) at rated voltage							Potenza Power kW	Coppia vel. nomin. Torque at rated speed Nm	Rendimento Efficiency %	Circuito di armatura Armature circuit			Max giri Max. speed (°)	
	400	440	460	520	600	700	810				Corrente Current Amp	Res. 115°C mOhm	Ind. mH		
67	244	---	---	---	---	---	---	134	5244	79.8	420	172	2.74	894	
		274	---	---	---	---	---	150	5228	81.2					916
		289	---	---	---	---	---	158	5221	81.8					925
		335	---	---	---	---	---	183	5217	83.8					949
		395	---	---	---	---	---	216	5222	85.7					974
		470	---	---	---	---	---	257	5222	87.4					997
		550	---	---	---	---	---	302	5243	88.8					1016
68	229	---	---	---	---	---	---	121	5046	78.2	387	198	3.23	870	
		257	---	---	---	---	---	137	5091	80.5					978
		272	---	---	---	---	---	144	5056	80.9					990
		315	---	---	---	---	---	167	5063	83.0					1020
		370	---	---	---	---	---	197	5084	84.8					1050
		445	---	---	---	---	---	235	5043	86.7					1079
		520	---	---	---	---	---	276	5069	88.0					1103
69	218	---	---	---	---	---	---	119	5213	78.7	378	203	3.79	829	
		245	---	---	---	---	---	133	5184	80.0					932
		259	---	---	---	---	---	141	5199	81.1					945
		299	---	---	---	---	---	163	5206	82.9					973
		355	---	---	---	---	---	193	5192	85.1					1003
		420	---	---	---	---	---	229	5207	86.5					1030
		495	---	---	---	---	---	270	5209	88.2					1053
70	200	---	---	---	---	---	---	99.3	4741	75.2	330	271	3.41	759	
		226	---	---	---	---	---	112	4732	77.1					858
		239	---	---	---	---	---	119	4755	78.4					907
		278	---	---	---	---	---	138	4740	80.4					1055
		330	---	---	---	---	---	164	4746	82.8					1095
		395	---	---	---	---	---	196	4738	84.8					1131
		465	---	---	---	---	---	231	4744	86.4					1161

Nota (\*) - VENTILAZIONE SOLO L.O. / FAN ONLY SIDE COMMUTATOR

Nota (°) - Regolazione di campo / Field weakening



Potenza eccitazione Excitation power	(w)	6000	Tipo Size MGL C 400 S Ventilazione Ventilation IC 06
Cost. tempo eccitaz. Field time constant	(ms)	1150	
Massa del motore Mass of the motor	(Kg)	3500	
Momento d'inerzia rotore Rotor inertia moment	(Kgm2)	33.0	

Avv.	Velocità nominale n/min a tensione nominale di armatura Rated speed (rev/min) at rated voltage							Potenza Power kW	Coppia vel.nomin. Torque at rated speed Nm	Rendimento Efficiency %	Circuito di armatura Armature circuit			Max giri Max. speed (°)	
	400	440	460	520	600	700	810				Corrente Current Amp	Res. 115°C mOhm	Ind. mH		
39	1105	---	---	---	---	---	---	674	5825	93.6	1800	8.07	0.182	2074	*
		1220	---	---	---	---	---	745	5831	94.1	1800				
		---	1275	---	---	---	---	780	5842	94.2	1800				
		---	---	1450	---	---	---	886	5835	94.7	1800				
40	1015	---	---	---	---	---	---	637	5993	92.8	1716	10.5	0.151	1909	
		1120	---	---	---	---	---	705	6011	93.4	1716				
		---	1175	---	---	---	---	738	5998	93.5	1716				
		---	---	1335	---	---	---	839	6001	94.0	1716				
		---	---	---	1545	---	---	973	6014	94.5	1716				
41	940	---	---	---	---	---	---	600	6095	92.7	1618	11.5	0.196	1832	
		1040	---	---	---	---	---	664	6097	93.3	1618				
		---	1090	---	---	---	---	695	6089	93.4	1618				
		---	---	1240	---	---	---	790	6084	93.9	1618				
		---	---	---	1440	---	---	917	6081	94.5	1618				
42	880	---	---	---	---	---	---	555	6023	92.5	1500	13.6	0.248	1857	
		970	---	---	---	---	---	613	6035	92.9	1500				
		---	1020	---	---	---	---	643	6020	93.2	1500				
		---	---	1155	---	---	---	731	6044	93.7	1500				
		---	---	---	1345	---	---	848	6021	94.2	1500				
		---	---	---	---	1575	---	995	6033	94.8	1500				
43	815	---	---	---	---	---	---	543	6362	91.7	1480	16.1	0.235	1614	
		905	---	---	---	---	---	601	6342	92.3	1480				
		---	950	---	---	---	---	630	6333	92.5	1480				
		---	---	1080	---	---	---	717	6340	93.2	1480				
		---	---	---	1255	---	---	833	6338	93.8	1480				
		---	---	---	---	1475	---	978	6332	94.4	1480				
44	770	---	---	---	---	---	---	500	6201	91.4	1367	17.9	0.289	1555	
		850	---	---	---	---	---	554	6224	92.1	1367				
		---	895	---	---	---	---	581	6199	92.4	1367				
		---	---	1015	---	---	---	661	6219	93.0	1367				
		---	---	---	1180	---	---	768	6215	93.6	1367				
		---	---	---	---	1385	---	902	6219	94.3	1367				
		---	---	---	---	---	1615	1049	6203	94.7	1367				
		---	---	---	---	---	---	484	6331	91.7	1320				
45	730	---	---	---	---	---	---	535	6346	92.1	1320	18.4	0.338	1516	
		805	---	---	---	---	---	561	6340	92.4	1320				
		---	845	---	---	---	---	639	6356	93.1	1320				
		---	---	960	---	---	---	742	6326	93.7	1320				
		---	---	---	1120	---	---	872	6332	94.4	1320				
		---	---	---	---	1315	---	1014	6350	94.8	1320				
		---	---	---	---	---	---	484	6331	91.7	1320				
		---	---	---	---	---	---	535	6346	92.1	1320				

Nota (\*) - VENTILAZIONE SOLO L.O. / FAN ONLY SIDE COMMUTATOR

Nota (°) - Regolazione di campo / Field weakening



Potenza eccitazione Excitation power	(w)	6000	Tipo Size Ventilazione Ventilation	MGL C 400 S  IC 06
Cost. tempo eccitaz. Field time constant	(ms)	1150		
Massa del motore Mass of the motor	(Kg)	3500		
Momento d'inertzia rotore Rotor inertia moment	(Kgm2)	33.0		

Avv.	Velocità nominale n/min a tensione nominale di armatura Rated speed (rev/min) at rated voltage							Potenza Power kW	Coppia vel.nomin. Torque at rated speed Nm	Rendimento Efficiency %	Circuito di armatura Armature circuit			Max giri Max. speed (°)
	400	440	460	520	600	700	810				Corrente Current Amp	Res. 115°C mOhm	Ind. mH	
46	690	---	---	---	---	---	---	446	6172	91.1	1224	21.1	0.397	1465
		760	---	---	---	---	---	494	6207	91.7	1224			1487
		800	---	---	---	---	---	518	6183	92.0	1224			1497
		910	---	---	---	---	---	590	6191	92.7	1224			1522
		1060	---	---	---	---	---	686	6180	93.4	1224			1547
		1245	---	---	---	---	---	806	6182	94.1	1224			1572
		1445	---	---	---	---	---	938	6199	94.6	1224			1592
		---	---	---	---	---	---	---	---	---	---			---
47	650	---	---	---	---	---	---	408	5994	90.3	1130	26.1	0.38	1572
		720	---	---	---	---	---	452	5995	90.9	1130			1599
		755	---	---	---	---	---	474	5995	91.2	1130			1611
		860	---	---	---	---	---	541	6007	92.1	1130			1641
		1000	---	---	---	---	---	629	6007	92.8	1130			1674
		1175	---	---	---	---	---	740	6014	93.6	1130			1704
		1370	---	---	---	---	---	862	6008	94.2	1130			1729
		---	---	---	---	---	---	---	---	---	---			---
48	620	---	---	---	---	---	---	399	6145	90.2	1106	26.5	0.421	1518
		685	---	---	---	---	---	443	6176	91.0	1106			1545
		720	---	---	---	---	---	464	6154	91.2	1106			1557
		820	---	---	---	---	---	530	6172	92.2	1106			1587
		955	---	---	---	---	---	616	6160	92.8	1106			1618
		1120	---	---	---	---	---	725	6182	93.6	1106			1648
		1305	---	---	---	---	---	844	6176	94.2	1106			1673
		---	---	---	---	---	---	---	---	---	---			---
49	585	---	---	---	---	---	---	359	5860	89.8	1000	31.4	0.494	1610
		650	---	---	---	---	---	398	5847	90.5	1000			1642
		685	---	---	---	---	---	417	5813	90.7	1000			1656
		780	---	---	---	---	---	476	5828	91.5	1000			1692
		910	---	---	---	---	---	555	5824	92.5	1000			1730
		1070	---	---	---	---	---	652	5819	93.1	1000			1766
		1245	---	---	---	---	---	760	5829	93.8	1000			1796
		---	---	---	---	---	---	---	---	---	---			---
50	570	---	---	---	---	---	---	373	6249	89.7	1040	30.3	0.545	1663
		630	---	---	---	---	---	414	6275	90.5	1040			1698
		660	---	---	---	---	---	435	6294	90.9	1040			1714
		755	---	---	---	---	---	496	6273	91.7	1040			1754
		880	---	---	---	---	---	577	6261	92.5	1040			1796
		1035	---	---	---	---	---	679	6265	93.3	1040			1836
		1205	---	---	---	---	---	791	6269	93.9	1040			1870
		---	---	---	---	---	---	---	---	---	---			---
51	535	---	---	---	---	---	---	363	6479	89.9	1010	30.8	0.715	1474
		595	---	---	---	---	---	403	6468	90.7	1010			1503
		620	---	---	---	---	---	423	6515	91.0	1010			1516
		710	---	---	---	---	---	482	6483	91.8	1010			1549
		825	---	---	---	---	---	561	6494	92.6	1010			1584
		970	---	---	---	---	---	660	6498	93.4	1010			1617
		1130	---	---	---	---	---	769	6499	94.0	1010			1645
		---	---	---	---	---	---	---	---	---	---			---
52	500	---	---	---	---	---	---	328	6264	88.7	924	38.3	0.679	1426
		555	---	---	---	---	---	365	6280	89.8	924			1455
		580	---	---	---	---	---	383	6306	90.1	924			1469
		665	---	---	---	---	---	437	6275	91.0	924			1502
		775	---	---	---	---	---	509	6272	91.8	924			1538
		910	---	---	---	---	---	600	6296	92.8	924			1571
		1060	---	---	---	---	---	700	6306	93.5	924			1600
		---	---	---	---	---	---	---	---	---	---			---

Nota (\*) - VENTILAZIONE SOLO L.O. / FAN ONLY SIDE COMMUTATOR

Nota (°) - Regolazione di campo / Field weakening



Potenza eccitazione Excitation power	(w)	6000	Tipo Size	MGL C 400 S
Cost. tempo eccitaz. Field time constant	(ms)	1150	Ventilazione Ventilation	IC 06
Massa del motore Mass of the motor	(Kg)	3500		
Momento d'inerzia rotore Rotor inertia moment	(Kgm2)	33.0		

Avv.	Velocità nominale n/min a tensione nominale di armatura Rated speed (rev/min) at rated voltage							Potenza Power kW	Coppia vel.nomin. Torque at rated speed Nm	Rendimento Efficiency %	Circuito di armatura Armature circuit			Max giri Max. speed (°)
	400	440	460	520	600	700	810				Corrente Current Amp	Res. 115°C mOhm	Ind. mH	
53	470	---	---	---	---	---	---	319	6481	88.2	904	41.8	0.654	1371
		520	---	---	---	---	---	355	6519	89.2	904			1400
		545	---	---	---	---	---	372	6518	89.5	904			1413
		625	---	---	---	---	---	426	6509	90.6	904			1446
		730	---	---	---	---	---	497	6501	91.6	904			1481
		860	---	---	---	---	---	585	6496	92.4	904			1515
		1000	---	---	---	---	---	683	6522	93.3	904			1542
		---	---	---	---	---	---	---	---	---	---			---
54	440	---	---	---	---	---	---	293	6359	87.7	835	48.3	0.854	1326
		490	---	---	---	---	---	325	6334	88.5	835			1355
		515	---	---	---	---	---	342	6342	89.0	835			1368
		590	---	---	---	---	---	391	6328	90.1	835			1401
		685	---	---	---	---	---	456	6357	91.0	835			1437
		810	---	---	---	---	---	538	6343	92.0	835			1470
		945	---	---	---	---	---	628	6346	92.9	835			1498
		---	---	---	---	---	---	---	---	---	---			---
55	420	---	---	---	---	---	---	269	6116	87.3	770	53.3	0.966	1409
		465	---	---	---	---	---	299	6140	88.3	770			1444
		490	---	---	---	---	---	315	6139	88.9	770			1459
		560	---	---	---	---	---	360	6139	89.9	770			1500
		655	---	---	---	---	---	420	6123	90.9	770			1542
		770	---	---	---	---	---	496	6151	92.0	770			1583
		900	---	---	---	---	---	579	6143	92.8	770			1617
		---	---	---	---	---	---	---	---	---	---			---
56	415	---	---	---	---	---	---	267	6144	87.1	766	54.5	0.994	1564
		460	---	---	---	---	---	297	6166	88.1	766			1608
		485	---	---	---	---	---	312	6143	88.5	766			1627
		555	---	---	---	---	---	357	6143	89.6	766			1678
		645	---	---	---	---	---	417	6174	90.7	766			1732
		765	---	---	---	---	---	492	6142	91.8	766			1784
		890	---	---	---	---	---	575	6170	92.7	766			1828
		---	---	---	---	---	---	---	---	---	---			---
57	385	---	---	---	---	---	---	259	6424	86.8	746	58.0	1.30	1387
		430	---	---	---	---	---	289	6418	88.0	746			1424
		455	---	---	---	---	---	303	6359	88.3	746			1441
		520	---	---	---	---	---	347	6372	89.5	746			1483
		605	---	---	---	---	---	406	6408	90.7	746			1528
		715	---	---	---	---	---	479	6397	91.7	746			1571
		835	---	---	---	---	---	559	6393	92.5	746			1608
		---	---	---	---	---	---	---	---	---	---			---
58	360	---	---	---	---	---	---	234	6207	85.7	683	71.5	1.15	1336
		400	---	---	---	---	---	260	6207	86.5	683			1374
		420	---	---	---	---	---	274	6230	87.2	683			1390
		485	---	---	---	---	---	314	6182	88.4	683			1433
		565	---	---	---	---	---	367	6203	89.6	683			1479
		670	---	---	---	---	---	434	6186	90.8	683			1523
		780	---	---	---	---	---	508	6219	91.8	683			1560
		---	---	---	---	---	---	---	---	---	---			---
59	340	---	---	---	---	---	---	225	6319	85.2	660	75.0	1.40	1290
		380	---	---	---	---	---	251	6308	86.4	660			1333
		400	---	---	---	---	---	264	6303	87.0	660			1349
		455	---	---	---	---	---	303	6359	88.3	660			1392
		535	---	---	---	---	---	355	6337	89.6	660			1438
		630	---	---	---	---	---	419	6351	90.7	660			1482
		740	---	---	---	---	---	491	6336	91.8	660			1519
		---	---	---	---	---	---	---	---	---	---			---

Nota (\*) - VENTILAZIONE SOLO L.O. / FAN ONLY SIDE COMMUTATOR

Nota (°) - Regolazione di campo / Field weakening



Potenza eccitazione Excitation power (w) 6000	Tipo Size MGL C 400 S
Cost. tempo eccitaz. Field time constant (ms) 1150	Ventilazione Ventilation IC 06
Massa del motore Mass of the motor (Kg) 3500	
Momento d'inerzia rotore Rotor inertia moment (Kgm2) 33.0	

Avv.	Velocità nominale n/min a tensione nominale di armatura Rated speed (rev/min) at rated voltage							Potenza Power kW	Coppia vel.nomin. Torque at rated speed Nm	Rendimento Efficiency %	Circuito di armatura Armature circuit			Max giri Max. speed (°)	
	400	440	460	520	600	700	810				Corrente Current Amp	Res. 115°C mOhm	Ind. mH		
60	320	---	---	---	---	---	---	207	6177	84.6	612	85.4	1.58	1214	
		355	---	---	---	---	---	231	6214	85.8	612			1284	
		---	375	---	---	---	---	243	6188	86.3	612			1300	
		---	---	430	---	---	---	279	6196	87.7	612			1343	
		---	---	---	505	---	---	327	6183	89.1	612			1388	
		---	---	---	---	595	---	387	6211	90.3	612			1432	
		---	---	---	---	---	700	453	6180	91.4	612			1468	
		---	---	---	---	---	---	---	---	---	---			---	---
61	300	---	---	---	---	---	---	189	6016	83.8	564	98.4	1.89	1144	
		335	---	---	---	---	---	211	6015	85.0	564			1278	
		---	355	---	---	---	---	222	5972	85.6	564			1345	
		---	---	405	---	---	---	255	6013	86.9	564			1399	
		---	---	---	475	---	---	300	6031	88.7	564			1452	
		---	---	---	---	565	---	355	6000	89.9	564			1503	
		---	---	---	---	---	660	416	6019	91.1	564			1546	
		---	---	---	---	---	---	---	---	---	---			---	---
62	284	---	---	---	---	---	---	183	6153	83.0	551	108	1.74	1078	
		315	---	---	---	---	---	204	6184	84.1	551			1205	
		---	335	---	---	---	---	215	6129	84.8	551			1269	
		---	---	385	---	---	---	247	6126	86.2	551			1368	
		---	---	---	450	---	---	291	6175	88.0	551			1421	
		---	---	---	---	535	---	345	6158	89.4	551			1473	
		---	---	---	---	---	625	404	6173	90.5	551			1517	
		---	---	---	---	---	---	---	---	---	---			---	---
63	264	---	---	---	---	---	---	174	6294	82.1	530	118	2.06	992	
		296	---	---	---	---	---	195	6291	83.6	530			1016	
		---	310	---	---	---	---	205	6315	84.1	530			1027	
		---	---	360	---	---	---	237	6287	86.0	530			1054	
		---	---	---	420	---	---	278	6321	87.4	530			1081	
		---	---	---	---	500	---	330	6303	88.9	530			1108	
		---	---	---	---	---	585	387	6317	90.1	530			1129	
		---	---	---	---	---	---	---	---	---	---			---	---
64	248	---	---	---	---	---	---	168	6469	82.2	511	121	2.65	884	
		278	---	---	---	---	---	188	6458	83.6	511			904	
		---	293	---	---	---	---	198	6453	84.2	511			913	
		---	---	335	---	---	---	228	6499	85.8	511			936	
		---	---	---	395	---	---	269	6503	87.7	511			959	
		---	---	---	---	470	---	319	6481	89.2	511			981	
		---	---	---	---	---	550	374	6494	90.4	511			999	
		---	---	---	---	---	---	---	---	---	---			---	---
65	228	---	---	---	---	---	---	150	6282	80.1	468	152	2.66	850	
		255	---	---	---	---	---	168	6291	81.6	468			871	
		---	269	---	---	---	---	177	6283	82.2	468			880	
		---	---	310	---	---	---	205	6315	84.2	468			904	
		---	---	---	365	---	---	242	6331	86.2	468			928	
		---	---	---	---	435	---	287	6300	87.6	468			950	
		---	---	---	---	---	515	338	6267	89.2	468			969	
		---	---	---	---	---	---	---	---	---	---			---	---
66	212	---	---	---	---	---	---	144	6486	79.1	455	167	2.67	805	
		238	---	---	---	---	---	161	6460	80.4	455			840	
		---	251	---	---	---	---	170	6468	81.2	455			849	
		---	---	291	---	---	---	197	6465	83.3	455			873	
		---	---	---	345	---	---	233	6449	85.3	455			897	
		---	---	---	---	410	---	277	6452	87.0	455			920	
		---	---	---	---	---	---	480	327	6506	88.7			455	938
		---	---	---	---	---	---	---	---	---	---			---	---

Nota (\*) - VENTILAZIONE SOLO L.O. / FAN ONLY SIDE COMMUTATOR

Nota (°) - Regolazione di campo / Field weakening



Potenza eccitazione Excitation power	(w)	6000	Tipo Size Ventilazione Ventilation	MGL C 400 S  IC 06
Cost. tempo eccitaz. Field time constant	(ms)	1150		
Massa del motore Mass of the motor	(Kg)	3500		
Momento d'inerzia rotore Rotor inertia moment	(Kgm2)	33.0		

Avv.	Velocità nominale n/min a tensione nominale di armatura Rated speed (rev/min) at rated voltage							Potenza Power kW	Coppia vel.nomin. Torque at rated speed Nm	Rendimento Efficiency %	Circuito di armatura Armature circuit			Max giri Max. speed (°)
	400	440	460	520	600	700	810				Corrente Current Amp	Res. 115°C mOhm	Ind. mH	
67	199	---	---	---	---	---	---	131	6286	78.0	420	187	3.20	757
		224	---	---	---	---	---	148	6309	80.1	420			812
		237	---	---	---	---	---	156	6286	80.7	420			822
		274	---	---	---	---	---	181	6308	82.9	420			845
		325	---	---	---	---	---	214	6288	84.9	420			869
		385	---	---	---	---	---	255	6325	86.7	420			892
		455	---	---	---	---	---	300	6296	88.2	420			911
68	187	---	---	---	---	---	---	119	6077	76.9	387	215	3.77	709
		210	---	---	---	---	---	134	6093	78.7	387			800
		222	---	---	---	---	---	142	6108	79.8	387			845
		258	---	---	---	---	---	165	6107	82.0	387			910
		305	---	---	---	---	---	195	6105	84.0	387			941
		365	---	---	---	---	---	233	6096	86.0	387			969
		430	---	---	---	---	---	275	6107	87.7	387			993
69	178	---	---	---	---	---	---	116	6223	76.7	378	221	4.44	676
		200	---	---	---	---	---	131	6255	78.8	378			762
		212	---	---	---	---	---	139	6261	79.9	378			805
		246	---	---	---	---	---	161	6250	81.9	378			867
		291	---	---	---	---	---	191	6268	84.2	378			896
		345	---	---	---	---	---	228	6311	86.2	378			924
		410	---	---	---	---	---	268	6242	87.5	378			946
70	162	---	---	---	---	---	---	97.0	5718	73.5	330	295	3.96	617
		184	---	---	---	---	---	110	5709	75.8	330			699
		195	---	---	---	---	---	116	5681	76.4	330			740
		227	---	---	---	---	---	136	5721	79.3	330			863
		270	---	---	---	---	---	162	5730	81.8	330			978
		325	---	---	---	---	---	194	5700	84.0	330			1014
		385	---	---	---	---	---	229	5680	85.7	330			1043

Nota (\*) - VENTILAZIONE SOLO L.O. / FAN ONLY SIDE COMMUTATOR

Nota (°) - Regolazione di campo / Field weakening



Potenza eccitazione Excitation power	(w)	6600	Tipo Size Ventilazione Ventilation	MGL C 400 M IC 06
Cost. tempo eccitaz. Field time constant	(ms)	1220		
Massa del motore Mass of the motor	(Kg)	3900		
Momento d'inerzia rotore Rotor inertia moment	(Kgm2)	36.4		

Avv.	Velocità nominale n/min a tensione nominale di armatura Rated speed (rev/min) at rated voltage							Potenza Power kW	Coppia vel.nomin. Torque at rated speed Nm	Rendimento Efficiency %	Circuito di armatura Armature circuit			Max giri Max. speed (°)
	400	440	460	520	600	700	810				Corrente Current Amp	Res. 115°C mOhm	Ind. mH	
39	925	---	---	---	---	---	---	674	6958	93.6	1800	8.86	0.213	1890
		1020	---	---	---	---	---	744	6965	93.9				1917
		1070	---	---	---	---	---	780	6961	94.2				1929
			1215	---	---	---	---	886	6964	94.7				1959
40	845	---	---	---	---	---	---	636	7187	92.7	1716	11.5	0.176	1732
		935	---	---	---	---	---	703	7180	93.1				1756
		980	---	---	---	---	---	737	7182	93.4				1767
			1115	---	---	---	---	838	7177	93.9				1795
		1295	---	---	---	---	973	7175	94.5	1824				
41	785	---	---	---	---	---	---	599	7287	92.6	1618	12.6	0.228	1658
		870	---	---	---	---	---	662	7266	93.0				1683
		910	---	---	---	---	---	694	7283	93.2				1693
			1040	---	---	---	---	789	7245	93.8				1721
		1205	---	---	---	---	917	7267	94.5	1750				
42	735	---	---	---	---	---	---	553	7185	92.2	1500	14.9	0.29	1681
		810	---	---	---	---	---	612	7215	92.7				1708
		850	---	---	---	---	---	642	7213	93.0				1720
			970	---	---	---	---	730	7187	93.6				1751
		1125	---	---	---	---	848	7198	94.2	1782				
		1320	---	---	---	---	995	7198	94.8	1813				
43	685	---	---	---	---	---	---	541	7542	91.4	1480	17.6	0.274	1451
		755	---	---	---	---	---	599	7576	92.0				1473
		795	---	---	---	---	---	628	7543	92.2				1482
			905	---	---	---	---	715	7545	92.9				1507
		1050	---	---	---	---	832	7567	93.7	1533				
		1235	---	---	---	---	977	7554	94.3	1557				
44	640	---	---	---	---	---	---	498	7431	91.1	1367	19.6	0.337	1392
		710	---	---	---	---	---	552	7424	91.8				1414
		745	---	---	---	---	---	579	7422	92.1				1423
			850	---	---	---	---	660	7415	92.8				1447
		990	---	---	---	---	767	7398	93.5	1472				
		1160	---	---	---	---	901	7417	94.2	1496				
		1350	---	---	---	---	1049	7420	94.7	1516				
		45	610	---	---	---	---	---	---	482				7546
675	---			---	---	---	---	534	7555	91.9	1378			
705	---			---	---	---	---	560	7585	92.2	1388			
	805			---	---	---	---	637	7556	92.8	1412			
935	---			---	---	---	741	7568	93.6	1437				
1100	---			---	---	---	871	7561	94.3	1461				
1280	---			---	---	---	1013	7557	94.7	1481				

Nota (\*) - VENTILAZIONE SOLO L.O. / FAN ONLY SIDE COMMUTATOR

Nota (°) - Regolazione di campo / Field weakening





Potenza eccitazione Excitation power	(w)	6600	Tipo Size Ventilazione Ventilation	MGL C 400 M  IC 06
Cost. tempo eccitaz. Field time constant	(ms)	1220		
Massa del motore Mass of the motor	(Kg)	3900		
Momento d'inerzia rotore Rotor inertia moment	(Kgm2)	36.4		

Avv.	Velocità nominale n/min a tensione nominale di armatura Rated speed (rev/min) at rated voltage							Potenza Power kW	Coppia vel.nomin. Torque at rated speed Nm	Rendimento Efficiency %	Circuito di armatura Armature circuit			Max giri Max. speed (°)
	400	440	460	520	600	700	810				Corrente Current Amp	Res. 115°C mOhm	Ind. mH	
46	575	---	---	---	---	---	---	445	7390	90.9	1224	23.0	0.463	1307
		635	---	---	---	---	---	493	7414	91.5	1224			1328
		665	---	---	---	---	---	517	7424	91.8	1224			1337
		---	760	---	---	---	---	589	7401	92.5	1224			1361
		---	---	885	---	---	---	685	7391	93.3	1224			1386
		---	---	---	1040	---	---	805	7392	94.0	1224			1409
		---	---	---	---	---	1210	937	7395	94.5	1224			1429
		---	---	---	---	---	---	---	---	---	---			---
47	540	---	---	---	---	---	---	406	7180	89.8	1130	28.5	0.442	1405
		600	---	---	---	---	---	450	7162	90.5	1130			1431
		630	---	---	---	---	---	472	7154	90.8	1130			1442
		---	715	---	---	---	---	539	7199	91.7	1130			1472
		---	---	835	---	---	---	628	7182	92.6	1130			1503
		---	---	---	985	---	---	739	7164	93.4	1130			1533
		---	---	---	---	---	1145	861	7181	94.1	1130			1558
		---	---	---	---	---	---	---	---	---	---			---
48	515	---	---	---	---	---	---	398	7380	90.0	1106	28.9	0.489	1356
		570	---	---	---	---	---	441	7388	90.6	1106			1382
		600	---	---	---	---	---	463	7369	91.0	1106			1393
		---	685	---	---	---	---	528	7361	91.8	1106			1422
		---	---	795	---	---	---	615	7387	92.7	1106			1453
		---	---	---	940	---	---	723	7345	93.4	1106			1482
		---	---	---	---	---	1095	843	7352	94.1	1106			1506
		---	---	---	---	---	---	---	---	---	---			---
49	490	---	---	---	---	---	---	359	6996	89.8	1000	34.4	0.574	1438
		545	---	---	---	---	---	398	6974	90.5	1000			1469
		570	---	---	---	---	---	417	6986	90.7	1000			1482
		---	650	---	---	---	---	476	6993	91.5	1000			1517
		---	---	760	---	---	---	555	6974	92.5	1000			1554
		---	---	---	895	---	---	652	6957	93.1	1000			1589
		---	---	---	---	---	1040	760	6978	93.8	1000			1618
		---	---	---	---	---	---	---	---	---	---			---
50	475	---	---	---	---	---	---	371	7459	89.2	1040	33.2	0.636	1496
		525	---	---	---	---	---	412	7494	90.0	1040			1531
		550	---	---	---	---	---	433	7518	90.5	1040			1546
		---	630	---	---	---	---	494	7488	91.3	1040			1585
		---	---	735	---	---	---	576	7484	92.3	1040			1627
		---	---	---	865	---	---	678	7485	93.1	1040			1667
		---	---	---	---	---	1005	790	7506	93.8	1040			1700
		---	---	---	---	---	---	---	---	---	---			---
51	445	---	---	---	---	---	---	361	7747	89.4	1010	33.7	0.836	1318
		495	---	---	---	---	---	401	7736	90.2	1010			1346
		520	---	---	---	---	---	421	7731	90.6	1010			1359
		---	590	---	---	---	---	480	7769	91.4	1010			1391
		---	---	690	---	---	---	560	7750	92.4	1010			1425
		---	---	---	810	---	---	659	7769	93.2	1010			1457
		---	---	---	---	---	945	768	7761	93.9	1010			1484
		---	---	---	---	---	---	---	---	---	---			---
52	415	---	---	---	---	---	---	326	7501	88.2	924	41.9	0.791	1269
		460	---	---	---	---	---	362	7515	89.0	924			1298
		---	485	---	---	---	---	381	7502	89.6	924			1311
		---	---	555	---	---	---	435	7485	90.5	924			1343
		---	---	---	645	---	---	508	7521	91.6	924			1377
		---	---	---	---	760	---	598	7514	92.5	924			1410
		---	---	---	---	---	885	698	7532	93.3	924			1437
		---	---	---	---	---	---	---	---	---	---			---

Nota (\*) - VENTILAZIONE SOLO L.O. / FAN ONLY SIDE COMMUTATOR

Nota (°) - Regolazione di campo / Field weakening



Potenza eccitazione Excitation power	(w)	6600	Tipo Size Ventilazione Ventilation	MGL C 400 M IC 06
Cost. tempo eccitaz. Field time constant	(ms)	1220		
Massa del motore Mass of the motor	(Kg)	3900		
Momento d'inerzia rotore Rotor inertia moment	(Kgm2)	36.4		

Avv.	Velocità nominale n/min a tensione nominale di armatura Rated speed (rev/min) at rated voltage							Potenza Power kW	Coppia vel.nomin. Torque at rated speed Nm	Rendimento Efficiency %	Circuito di armatura Armature circuit			Max giri Max. speed (°)	
	400	440	460	520	600	700	810				Corrente Current Amp	Res. 115°C mOhm	Ind. mH		
53	390	---	---	---	---	---	---	317	7762	87.7	904	45.6	0.760	1220	
		435	---	---	---	---	---	352	7727	88.5					1248
		455	---	---	---	---	---	370	7765	89.0					1260
		---	520	---	---	---	---	424	7786	90.2					1292
		---	---	605	---	---	---	495	7813	91.3					1326
		---	---	---	715	---	---	583	7786	92.1					1358
		---	---	---	---	---	835	681	7788	93.0					1385
		---	---	---	---	---	---	---	---	---					---
54	365	---	---	---	---	---	---	290	7587	86.8	835	52.9	0.996	1175	
		410	---	---	---	---	---	323	7523	87.9					1203
		430	---	---	---	---	---	339	7528	88.3					1216
		---	490	---	---	---	---	389	7581	89.6					1248
		---	---	575	---	---	---	454	7540	90.6					1281
		---	---	---	675	---	---	536	7583	91.7					1313
		---	---	---	---	---	790	627	7579	92.7					1340
		---	---	---	---	---	---	---	---	---					---
55	350	---	---	---	---	---	---	267	7285	86.7	770	58.2	1.13	1251	
		385	---	---	---	---	---	297	7367	87.7					1284
		405	---	---	---	---	---	312	7357	88.1					1299
		---	465	---	---	---	---	358	7352	89.4					1338
		---	---	545	---	---	---	418	7324	90.5					1379
		---	---	---	645	---	---	494	7314	91.7					1418
		---	---	---	---	---	750	577	7347	92.5					1451
		---	---	---	---	---	---	---	---	---					---
56	345	---	---	---	---	---	---	265	7335	86.5	766	59.6	1.16	1308	
		385	---	---	---	---	---	295	7317	87.5					1440
		405	---	---	---	---	---	310	7309	88.0					1459
		---	460	---	---	---	---	355	7370	89.1					1508
		---	---	540	---	---	---	416	7357	90.5					1561
		---	---	---	635	---	---	491	7384	91.6					1612
		---	---	---	---	---	745	574	7357	92.5					1656
		---	---	---	---	---	---	---	---	---					---
57	320	---	---	---	---	---	---	257	7669	86.1	746	63.5	1.52	1222	
		360	---	---	---	---	---	286	7586	87.1					1268
		---	375	---	---	---	---	301	7665	87.7					1284
		---	---	430	---	---	---	345	7662	88.9					1325
		---	---	---	505	---	---	404	7639	90.3					1369
		---	---	---	---	595	---	477	7656	91.3					1411
		---	---	---	---	---	700	558	7612	92.3					1446
		---	---	---	---	---	---	---	---	---					---
58	298	---	---	---	---	---	---	231	7402	84.6	683	78.2	1.34	1133	
		335	---	---	---	---	---	258	7354	85.9					1218
		---	350	---	---	---	---	271	7394	86.3					1234
		---	---	400	---	---	---	312	7449	87.8					1275
		---	---	---	470	---	---	365	7416	89.1					1319
		---	---	---	---	560	---	432	7367	90.4					1361
		---	---	---	---	---	655	506	7377	91.5					1397
		---	---	---	---	---	---	---	---	---					---
59	281	---	---	---	---	---	---	223	7578	84.5	660	82.1	1.63	1069	
		315	---	---	---	---	---	249	7549	85.7					1181
		---	330	---	---	---	---	262	7582	86.3					1197
		---	---	380	---	---	---	301	7564	87.7					1238
		---	---	---	445	---	---	353	7575	89.1					1282
		---	---	---	---	525	---	417	7585	90.3					1324
		---	---	---	---	---	615	489	7593	91.5					1360
		---	---	---	---	---	---	---	---	---					---

Nota (\*) - VENTILAZIONE SOLO L.O. / FAN ONLY SIDE COMMUTATOR

Nota (°) - Regolazione di campo / Field weakening



Potenza eccitazione  
Excitation power (w) 6600  
Cost. tempo eccitaz.  
Field time constant (ms) 1220  
Massa del motore  
Mass of the motor (Kg) 3900  
Momento d'inerzia rotore  
Rotor inertia moment (Kgm2) 36.4

Tipo  
Size MGL C 400 M  
Ventilazione  
Ventilation IC 06

Avv.	Velocità nominale n/min a tensione nominale di armatura Rated speed (rev/min) at rated voltage							Potenza Power kW	Coppia vel.nomin. Torque at rated speed Nm	Rendimento Efficiency %	Circuito di armatura Armature circuit			Max giri Max. speed (°)
	400	440	460	520	600	700	810				Corrente Current Amp	Res. 115°C mOhm	Ind. mH	
60	265	---	---	---	---	---	---	205	7387	83.7	612	93.5	1.84	1005
		296	---	---	---	---	---	229	7388	85.0				1123
		---	310	---	---	---	---	241	7424	85.6				1149
		---	---	360	---	---	---	277	7348	87.0				1190
		---	---	---	420	---	---	325	7389	88.5				1233
		---	---	---	---	495	---	385	7427	89.9				1275
		---	---	---	---	---	585	451	7362	91.0				1310
61	249	---	---	---	---	---	---	187	7172	82.9	564	108	2.2	946
		279	---	---	---	---	---	209	7153	84.2				1059
		---	293	---	---	---	---	220	7170	84.8				1115
		---	---	340	---	---	---	253	7106	86.3				1240
		---	---	---	395	---	---	297	7180	87.8				1290
		---	---	---	---	470	---	353	7172	89.4				1339
		---	---	---	---	---	550	414	7188	90.6				1380
62	234	---	---	---	---	---	---	180	7346	81.7	551	118	2.03	890
		262	---	---	---	---	---	202	7362	83.3				997
		---	277	---	---	---	---	213	7343	84.0				1051
		---	---	320	---	---	---	245	7311	85.5				1211
		---	---	---	375	---	---	288	7334	87.1				1263
		---	---	---	---	445	---	342	7339	88.7				1313
		---	---	---	---	---	525	402	7312	90.1				1355
63	218	---	---	---	---	---	---	172	7534	81.1	530	129	2.40	829
		245	---	---	---	---	---	192	7484	82.3				913
		---	258	---	---	---	---	203	7514	83.3				924
		---	---	298	---	---	---	234	7498	84.9				950
		---	---	---	350	---	---	276	7530	86.8				978
		---	---	---	---	415	---	328	7547	88.4				1004
		---	---	---	---	---	490	385	7503	89.7				1026
64	205	---	---	---	---	---	---	166	7733	81.2	511	133	3.10	779
		230	---	---	---	---	---	186	7723	82.7				808
		---	242	---	---	---	---	196	7734	83.4				817
		---	---	280	---	---	---	226	7708	85.1				839
		---	---	---	330	---	---	266	7697	86.8				862
		---	---	---	---	390	---	316	7737	88.3				883
		---	---	---	---	---	460	372	7723	89.9				901
65	187	---	---	---	---	---	---	147	7507	78.5	468	166	3.10	712
		211	---	---	---	---	---	166	7513	80.6				774
		---	222	---	---	---	---	175	7528	81.3				783
		---	---	258	---	---	---	202	7477	83.0				806
		---	---	---	305	---	---	239	7483	85.1				830
		---	---	---	---	365	---	285	7456	87.0				852
		---	---	---	---	---	425	336	7550	88.6				870
66	174	---	---	---	---	---	---	141	7738	77.5	455	183	3.10	662
		196	---	---	---	---	---	159	7747	79.4				746
		---	207	---	---	---	---	168	7750	80.3				755
		---	---	241	---	---	---	194	7687	82.0				778
		---	---	---	285	---	---	230	7707	84.2				802
		---	---	---	---	340	---	275	7724	86.3				824
		---	---	---	---	---	400	324	7735	87.9				842

Nota (\*) - VENTILAZIONE SOLO L.O. / FAN ONLY SIDE COMMUTATOR

Nota (°) - Regolazione di campo / Field weakening



Potenza eccitazione Excitation power	(w)	6600	Tipo Size Ventilazione Ventilation	MGL C 400 M IC 06
Cost. tempo eccitaz. Field time constant	(ms)	1220		
Massa del motore Mass of the motor	(Kg)	3900		
Momento d'inerzia rotore Rotor inertia moment	(Kgm2)	36.4		

Avv.	Velocità nominale n/min a tensione nominale di armatura Rated speed (rev/min) at rated voltage							Potenza Power kW	Coppia vel.nomin. Torque at rated speed Nm	Rendimento Efficiency %	Circuito di armatura Armature circuit			Max giri Max. speed (°)	
	400	440	460	520	600	700	810				Corrente Current Amp	Res. 115°C mOhm	Ind. mH		
67	164	---	---	---	---	---	---	129	7511	76.8	420	205	3.72	621	
		184	---	---	---	---	---	145	7525	78.5					701
		---	195	---	---	---	---	153	7493	79.2					728
		---	---	226	---	---	---	178	7521	81.5					750
		---	---	---	268	---	---	211	7518	83.7					774
		---	---	---	---	320	---	252	7520	85.7					796
		---	---	---	---	---	380	298	7489	87.6					814
		---	---	---	---	---	---	---	---	---					---
68	153	---	---	---	---	---	---	117	7302	75.6	387	236	4.40	581	
		173	---	---	---	---	---	132	7286	77.5					657
		---	183	---	---	---	---	139	7253	78.1					695
		---	---	213	---	---	---	162	7263	80.5					808
		---	---	---	253	---	---	193	7285	83.1					839
		---	---	---	---	300	---	231	7353	85.3					867
		---	---	---	---	---	355	272	7317	86.8					890
		---	---	---	---	---	---	---	---	---					---
69	146	---	---	---	---	---	---	114	7456	75.4	378	241	5.18	554	
		165	---	---	---	---	---	129	7466	77.6					626
		---	174	---	---	---	---	136	7464	78.2					662
		---	---	203	---	---	---	158	7433	80.4					770
		---	---	---	241	---	---	188	7449	82.9					799
		---	---	---	---	288	---	225	7460	85.0					825
		---	---	---	---	---	340	266	7471	86.9					847
		---	---	---	---	---	---	---	---	---					---
70	132	---	---	---	---	---	---	94.4	6829	71.5	330	323	4.60	502	
		150	---	---	---	---	---	107	6812	73.7					571
		---	159	---	---	---	---	114	6847	75.1					606
		---	---	187	---	---	---	133	6792	77.5					709
		---	---	---	223	---	---	159	6809	80.3					847
		---	---	---	---	268	---	192	6841	83.1					905
		---	---	---	---	---	320	227	6774	84.9					934
		---	---	---	---	---	---	---	---	---					---

Nota (\*) - VENTILAZIONE SOLO L.O. / FAN ONLY SIDE COMMUTATOR

Nota (°) - Regolazione di campo / Field weakening



Potenza eccitazione Excitation power	(w)	7400	Tipo Size MGL C 400 L Ventilazione Ventilation IC 06
Cost. tempo eccitaz. Field time constant	(ms)	1300	
Massa del motore Mass of the motor	(Kg)	4400	
Momento d'inerzia rotore Rotor inertia moment	(Kgm2)	40.7	

Avv.	Velocità nominale n/min a tensione nominale di armatura Rated speed (rev/min) at rated voltage							Potenza Power kW	Coppia vel.nomin. Torque at rated speed Nm	Rendimento Efficiency %	Circuito di armatura Armature circuit			Max giri Max. speed (°)	
	400	440	460	520	600	700	810				Corrente Current Amp	Res. 115°C mOhm	Ind. mH		
39	765	---	---	---	---	---	---	672	8388	93.3	1800	9.84	0.252	1701	
		845	---	---	---	---	---	743	8397	93.8	1800				1727
		---	885	---	---	---	---	778	8395	94.0	1800				1739
		---	---	1010	---	---	---	885	8368	94.6	1800				1769
40	700	---	---	---	---	---	---	634	8649	92.4	1716	12.7	0.207	1551	
		775	---	---	---	---	---	701	8638	92.8	1716				1575
		---	815	---	---	---	---	735	8612	93.1	1716				1586
		---	---	925	---	---	---	837	8641	93.8	1716				1613
---	---	---	1075	---	---	---	972	8634	94.4	1716	1641				
41	650	---	---	---	---	---	---	597	8771	92.2	1618	13.9	0.269	1482	
		720	---	---	---	---	---	660	8754	92.7	1618				1506
		---	755	---	---	---	---	692	8753	93.0	1618				1516
		---	---	860	---	---	---	788	8750	93.7	1618				1543
---	---	---	1000	---	---	---	915	8738	94.3	1618	1571				
42	610	---	---	---	---	---	---	551	8626	91.8	1500	16.5	0.342	1503	
		675	---	---	---	---	---	610	8630	92.4	1500				1529
		---	705	---	---	---	---	639	8655	92.6	1500				1540
		---	---	805	---	---	---	728	8636	93.3	1500				1570
---	---	---	935	---	---	---	846	8640	94.0	1500	1601				
---	---	---	1095	---	---	---	994	8669	94.7	1500	1631				
43	565	---	---	---	---	---	---	538	9093	90.9	1480	19.4	0.321	1288	
		625	---	---	---	---	---	596	9106	91.5	1480				1309
		---	655	---	---	---	---	625	9112	91.8	1480				1318
		---	---	750	---	---	---	713	9078	92.6	1480				1342
---	---	---	870	---	---	---	829	9099	93.4	1480	1366				
---	---	---	1025	---	---	---	975	9084	94.1	1480	1390				
44	530	---	---	---	---	---	---	496	8937	90.7	1367	21.7	0.396	1231	
		590	---	---	---	---	---	549	8886	91.3	1367				1251
		---	620	---	---	---	---	576	8872	91.6	1367				1260
		---	---	705	---	---	---	657	8899	92.4	1367				1283
---	---	---	820	---	---	---	765	8909	93.3	1367	1307				
---	---	---	965	---	---	---	899	8896	93.9	1367	1330				
---	---	---	1120	---	---	---	1047	8927	94.6	1367	1349				
45	505	---	---	---	---	---	---	479	9058	90.7	1320	22.2	0.464	1199	
		555	---	---	---	---	---	531	9136	91.4	1320				1219
		---	585	---	---	---	---	557	9092	91.7	1320				1228
		---	---	665	---	---	---	635	9119	92.5	1320				1251
---	---	---	775	---	---	---	739	9106	93.3	1320	1275				
---	---	---	910	---	---	---	869	9119	94.0	1320	1298				
---	---	---	1060	---	---	---	1012	9117	94.7	1320	1317				

Nota (\*) - VENTILAZIONE SOLO L.O. / FAN ONLY SIDE COMMUTATOR

Nota (°) - Regolazione di campo / Field weakening



Potenza eccitazione Excitation power (w) 7400	Tipologia Tipo MGL C 400 L
Cost. tempo eccitaz. Field time constant (ms) 1300	Ventilazione Ventilation IC 06
Massa del motore Mass of the motor (Kg) 4400	
Momento d'inerzia rotore Rotor inertia moment (Kgm2) 40.7	

Avv.	Velocità nominale n/min a tensione nominale di armatura Rated speed (rev/min) at rated voltage							Potenza Power kW	Coppia vel.nomin. Torque at rated speed Nm	Rendimento Efficiency %	Circuito di armatura Armature circuit			Max giri Max. speed (°)
	400	440	460	520	600	700	810				Corrente Current Amp	Res. 115°C mOhm	Ind. mH	
46	475	---	---	---	---	---	---	442	8886	90.3	1224	25.5	0.546	1150
		525	---	---	---	---	---	490	8913	91.0	1224			1170
		---	550	---	---	---	---	514	8924	91.3	1224			1179
		---	---	630	---	---	---	586	8882	92.1	1224			1202
		---	---	---	735	---	---	683	8874	93.0	1224			1225
		---	---	---	---	865	---	803	8865	93.7	1224			1248
		---	---	---	---	---	1005	936	8894	94.4	1224			1266
		---	---	---	---	---	---	---	---	---	---			---
47	445	---	---	---	---	---	---	403	8648	89.2	1130	31.6	0.519	1239
		495	---	---	---	---	---	447	8623	89.9	1130			1264
		---	520	---	---	---	---	470	8631	90.4	1130			1275
		---	---	595	---	---	---	536	8602	91.2	1130			1304
		---	---	---	690	---	---	625	8650	92.2	1130			1333
		---	---	---	---	815	---	736	8624	93.0	1130			1362
		---	---	---	---	---	950	859	8635	93.8	1130			1385
		---	---	---	---	---	---	---	---	---	---			---
48	425	---	---	---	---	---	---	395	8875	89.3	1106	32.0	0.574	1196
		470	---	---	---	---	---	438	8899	90.0	1106			1220
		---	495	---	---	---	---	460	8874	90.4	1106			1231
		---	---	565	---	---	---	525	8873	91.3	1106			1259
		---	---	---	660	---	---	612	8855	92.2	1106			1288
		---	---	---	---	780	---	721	8827	93.1	1106			1316
		---	---	---	---	---	905	841	8874	93.9	1106			1339
		---	---	---	---	---	---	---	---	---	---			---
49	405	---	---	---	---	---	---	354	8347	88.5	1000	38.1	0.675	1268
		450	---	---	---	---	---	393	8340	89.3	1000			1297
		---	470	---	---	---	---	413	8391	89.8	1000			1310
		---	---	540	---	---	---	472	8347	90.8	1000			1343
		---	---	---	630	---	---	551	8352	91.8	1000			1379
		---	---	---	---	740	---	649	8375	92.7	1000			1412
		---	---	---	---	---	865	757	8357	93.5	1000			1440
		---	---	---	---	---	---	---	---	---	---			---
50	390	---	---	---	---	---	---	368	9011	88.5	1040	36.8	0.749	1328
		435	---	---	---	---	---	409	8979	89.4	1040			1361
		---	455	---	---	---	---	430	9025	89.9	1040			1376
		---	---	520	---	---	---	491	9017	90.8	1040			1414
		---	---	---	605	---	---	573	9044	91.8	1040			1455
		---	---	---	---	715	---	675	9015	92.7	1040			1493
		---	---	---	---	---	835	788	9012	93.5	1040			1526
		---	---	---	---	---	---	---	---	---	---			---
51	365	---	---	---	---	---	---	358	9366	88.6	1010	37.4	0.987	1163
		410	---	---	---	---	---	398	9270	89.6	1010			1190
		---	430	---	---	---	---	418	9283	90.0	1010			1202
		---	---	490	---	---	---	478	9315	91.0	1010			1233
		---	---	---	570	---	---	557	9332	91.9	1010			1265
		---	---	---	---	675	---	657	9295	92.9	1010			1297
		---	---	---	---	---	785	766	9318	93.6	1010			1322
		---	---	---	---	---	---	---	---	---	---			---
52	340	---	---	---	---	---	---	323	9072	87.4	924	46.3	0.932	1115
		380	---	---	---	---	---	359	9022	88.3	924			1142
		---	400	---	---	---	---	378	9024	88.9	924			1154
		---	---	455	---	---	---	432	9067	89.9	924			1185
		---	---	---	535	---	---	505	9014	91.1	924			1218
		---	---	---	---	630	---	596	9034	92.1	924			1249
		---	---	---	---	---	735	696	9043	93.0	924			1275
		---	---	---	---	---	---	---	---	---	---			---

Nota (\*) - VENTILAZIONE SOLO L.O. / FAN ONLY SIDE COMMUTATOR

Nota (°) - Regolazione di campo / Field weakening



Potenza eccitazione Excitation power (w) 7400	
Cost. tempo eccitaz. Field time constant (ms) 1300	
Massa del motore Mass of the motor (Kg) 4400	
Momento d'inerzia rotore Rotor inertia moment (Kgm2) 40.7	
Tipo Size MGL C 400 L	
Ventilazione Ventilation IC 06	

Avv.	Velocità nominale n/min a tensione nominale di armatura Rated speed (rev/min) at rated voltage							Potenza Power kW	Coppia vel.nomin. Torque at rated speed Nm	Rendimento Efficiency %	Circuito di armatura Armature circuit			Max giri Max. speed (°)
	400	440	460	520	600	700	810				Corrente Current Amp	Res. 115°C mOhm	Ind. mH	
53	320	---	---	---	---	---	---	314	9370	86.8	904	50.5	0.892	1071
		355	---	---	---	---	---	349	9388	87.7	904			1098
		---	375	---	---	---	---	367	9346	88.3	904			1109
		---	---	430	---	---	---	421	9349	89.6	904			1140
		---	---	---	500	---	---	492	9397	90.7	904			1172
		---	---	---	---	595	---	581	9325	91.8	904			1203
		---	---	---	---	---	695	679	9330	92.7	904			1229
		54	300	---	---	---	---	---	---	287	9136			85.9
335	---			---	---	---	---	320	9122	87.1	835	1054		
---	355			---	---	---	---	336	9038	87.5	835	1066		
---	---			405	---	---	---	386	9101	88.9	835	1096		
---	---			---	475	---	---	451	9067	90.0	835	1128		
---	---			---	---	560	---	534	9106	91.4	835	1159		
---	---			---	---	---	655	624	9097	92.3	835	1184		
55	286			---	---	---	---	---	---	264	8815	85.7	770	64.4
		320	---	---	---	---	---	294	8773	86.8	770	1127		
		---	335	---	---	---	---	309	8808	87.2	770	1141		
		---	---	385	---	---	---	355	8805	88.7	770	1178		
		---	---	---	450	---	---	416	8828	90.0	770	1217		
		---	---	---	---	530	---	491	8847	91.1	770	1254		
		---	---	---	---	---	620	575	8856	92.2	770	1286		
		56	283	---	---	---	---	---	---	262	8841	85.5	766	
315	---			---	---	---	---	292	8852	86.6	766	1198		
---	330			---	---	---	---	307	8884	87.1	766	1260		
---	---			380	---	---	---	352	8846	88.4	766	1338		
---	---			---	445	---	---	413	8863	89.9	766	1389		
---	---			---	---	525	---	488	8876	91.0	766	1439		
---	---			---	---	---	615	571	8866	92.0	766	1480		
57	264			---	---	---	---	---	---	254	9188	85.1	746	70.4
		295	---	---	---	---	---	283	9161	86.2	746	1114		
		---	310	---	---	---	---	298	9180	86.8	746	1129		
		---	---	355	---	---	---	342	9200	88.2	746	1168		
		---	---	---	415	---	---	401	9227	89.6	746	1210		
		---	---	---	---	495	---	474	9144	90.8	746	1250		
		---	---	---	---	---	580	555	9138	91.8	746	1284		
		58	244	---	---	---	---	---	---	228	8923	83.5	683	
273	---			---	---	---	---	255	8920	84.9	683	1038		
---	288			---	---	---	---	268	8886	85.3	683	1080		
---	---			330	---	---	---	308	8913	86.7	683	1119		
---	---			---	390	---	---	362	8864	88.3	683	1161		
---	---			---	---	460	---	430	8927	89.9	683	1201		
---	---			---	---	---	540	503	8895	90.9	683	1235		
59	230			---	---	---	---	---	---	220	9134	83.3	660	90.9
		258	---	---	---	---	---	246	9105	84.7	660	979		
		---	271	---	---	---	---	259	9127	85.3	660	1031		
		---	---	310	---	---	---	298	9180	86.8	660	1086		
		---	---	---	365	---	---	350	9157	88.4	660	1128		
		---	---	---	---	435	---	415	9110	89.8	660	1168		
		---	---	---	---	---	510	486	9100	90.9	660	1202		

Nota (\*) - VENTILAZIONE SOLO L.O. / FAN ONLY SIDE COMMUTATOR

Nota (°) - Regolazione di campo / Field weakening





Potenza eccitazione Excitation power	(w)	7400	Tipo Size Ventilazione Ventilation	MGL C 400 L IC 06
Cost. tempo eccitaz. Field time constant	(ms)	1300		
Massa del motore Mass of the motor	(Kg)	4400		
Momento d'inerzia rotore Rotor inertia moment	(Kgm2)	40.7		

Avv.	Velocità nominale n/min a tensione nominale di armatura Rated speed (rev/min) at rated voltage							Potenza Power kW	Coppia vel.nomin. Torque at rated speed Nm	Rendimento Efficiency %	Circuito di armatura Armature circuit			Max giri Max. speed (°)		
	400	440	460	520	600	700	810				Corrente Current Amp	Res. 115°C mOhm	Ind. mH			
60	216	---	---	---	---	---	---	202	8930	82.5	612	104	2.17	823		
		242	---	---	---	---	---	226	8918	83.9					921	
		---	255	---	---	---	---	238	8913	84.5					970	
		---	---	294	---	---	---	274	8900	86.1					1040	
		---	---	---	345	---	---	322	8913	87.7					1081	
		---	---	---	---	410	---	382	8897	89.2					1120	
		---	---	---	---	---	480	449	8933	90.6					612	1153
		---	---	---	---	---	---	---	---	---					---	---
61	204	---	---	---	---	---	---	184	8613	81.6	564	119	2.60	773		
		228	---	---	---	---	---	206	8628	83.0					867	
		---	240	---	---	---	---	217	8634	83.6					914	
		---	---	277	---	---	---	250	8619	85.2					1054	
		---	---	---	325	---	---	295	8668	87.2					1131	
		---	---	---	---	390	---	350	8570	88.7					564	1177
		---	---	---	---	---	455	411	8626	90.0					564	1216
		---	---	---	---	---	---	---	---	---					---	---
62	191	---	---	---	---	---	---	177	8849	80.3	551	131	2.39	726		
		215	---	---	---	---	---	198	8794	81.7					816	
		---	226	---	---	---	---	209	8831	82.5					860	
		---	---	262	---	---	---	242	8820	84.5					994	
		---	---	---	310	---	---	285	8779	86.2					551	1107
		---	---	---	---	365	---	339	8869	87.9					551	1154
		---	---	---	---	---	430	399	8861	89.4					551	1194
		---	---	---	---	---	---	---	---	---					---	---
63	178	---	---	---	---	---	---	168	9013	79.2	530	143	2.83	676		
		200	---	---	---	---	---	189	9024	81.0					759	
		---	211	---	---	---	---	199	9006	81.6					801	
		---	---	244	---	---	---	231	9041	83.8					530	846
		---	---	---	288	---	---	273	9052	85.8					530	873
		---	---	---	---	345	---	325	8996	87.6					530	899
		---	---	---	---	---	405	382	9007	89.0					530	920
		---	---	---	---	---	---	---	---	---					---	---
64	167	---	---	---	---	---	---	162	9263	79.3	511	147	3.66	635		
		188	---	---	---	---	---	183	9295	81.4					712	
		---	198	---	---	---	---	193	9308	82.1					511	720
		---	---	229	---	---	---	223	9299	83.9					511	742
		---	---	---	271	---	---	263	9267	85.8					511	764
		---	---	---	---	320	---	313	9341	87.5					511	785
		---	---	---	---	---	380	369	9273	89.1					511	802
		---	---	---	---	---	---	---	---	---					---	---
65	152	---	---	---	---	---	---	144	9047	76.9	468	184	3.65	578		
		172	---	---	---	---	---	162	8994	78.7					468	652
		---	181	---	---	---	---	171	9022	79.4					468	687
		---	---	211	---	---	---	199	9006	81.8					468	709
		---	---	---	250	---	---	236	9015	84.0					468	732
		---	---	---	---	298	---	282	9037	86.1					468	753
		---	---	---	---	---	350	333	9086	87.8					468	771
		---	---	---	---	---	---	---	---	---					---	---
66	141	---	---	---	---	---	---	137	9278	75.3	455	202	3.65	536		
		159	---	---	---	---	---	155	9309	77.4					455	606
		---	169	---	---	---	---	164	9267	78.4					455	641
		---	---	196	---	---	---	191	9306	80.7					455	684
		---	---	---	233	---	---	227	9303	83.2					455	707
		---	---	---	---	279	---	272	9310	85.4					455	728
		---	---	---	---	---	---	330	9289	87.1					455	746
		---	---	---	---	---	---	---	---	---					---	---

Nota (\*) - VENTILAZIONE SOLO L.O. / FAN ONLY SIDE COMMUTATOR

Nota (°) - Regolazione di campo / Field weakening



Potenza eccitazione		
Excitation power	(w)	7400
Cost. tempo eccitaz.		
Field time constant	(ms)	1300
Massa del motore		
Mass of the motor	(Kg)	4400
Momento d'inerzia rotore		
Rotor inertia moment	(Kgm2)	40.7

Tipo	
Size	MGL C 400 L
Ventilazione	
Ventilation	IC 06

Avv.	Velocità nominale n/min a tensione nominale di armatura Rated speed (rev/min) at rated voltage							Potenza Power kW	Coppia vel.nomin. Torque at rated speed Nm	Rendimento Efficiency %	Circuito di armatura Armature circuit			Max giri Max. speed (°)	
	400	440	460	520	600	700	810				Corrente Current Amp	Res. 115°C mOhm	Ind. mH		
67	132	---	---	---	---	---	---	125	9043	74.4	420	227	4.38	502	
		150	---	---	---	---	---	142	9040	76.8					569
		---	158	---	---	---	---	150	9066	77.6					602
		---	---	185	---	---	---	175	9033	80.1					657
		---	---	---	220	---	---	208	9028	82.5					680
		---	---	---	---	263	---	249	9041	84.7					701
		---	---	---	---	---	310	295	9087	86.7					718
68	123	---	---	---	---	---	---	113	8773	73.0	387	261	5.18	469	
		140	---	---	---	---	---	128	8731	75.2					532
		---	148	---	---	---	---	136	8775	76.4					563
		---	---	173	---	---	---	159	8777	79.0					658
		---	---	---	206	---	---	189	8761	81.4					739
		---	---	---	---	248	---	227	8741	83.8					766
		---	---	---	---	---	294	269	8737	85.8					788
69	118	---	---	---	---	---	---	110	8902	72.8	378	267	6.11	447	
		133	---	---	---	---	---	125	8975	75.2					507
		---	141	---	---	---	---	133	9008	76.5					537
		---	---	165	---	---	---	155	8971	78.9					627
		---	---	---	197	---	---	185	8968	81.6					702
		---	---	---	---	236	---	222	8983	83.9					728
		---	---	---	---	---	280	263	8970	85.9					749
70	106	---	---	---	---	---	---	90.9	8189	68.9	330	357	5.40	402	
		121	---	---	---	---	---	104	8208	71.6					460
		---	129	---	---	---	---	110	8143	72.5					489
		---	---	151	---	---	---	130	8221	75.8					575
		---	---	---	181	---	---	156	8230	78.8					690
		---	---	---	---	219	---	188	8198	81.4					797
		---	---	---	---	---	261	224	8196	83.8					825

Nota (\*) - VENTILAZIONE SOLO L.O. / FAN ONLY SIDE COMMUTATOR

Nota (°) - Regolazione di campo / Field weakening



Potenza eccitazione Excitation power	(w)	8300	Tipo Size MGL C 400 P Ventilazione Ventilation IC 06
Cost. tempo eccitaz. Field time constant	(ms)	1400	
Massa del motore Mass of the motor	(Kg)	5000	
Momento d'inerzia rotore Rotor inertia moment	(Kgm2)	45.0	

Avv.	Velocità nominale n/min a tensione nominale di armatura Rated speed (rev/min) at rated voltage							Potenza Power kW	Coppia vel.nomin. Torque at rated speed Nm	Rendimento Efficiency %	Circuito di armatura Armature circuit			Max giri Max. speed (°)	
	400	440	460	520	600	700	810				Corrente Current Amp	Res. 115°C mOhm	Ind. mH		
39	635	---	---	---	---	---	---	670	10076	93.1	1800	11.0	0.299	1519	
		700	---	---	---	---	---	740	10095	93.4					1544
		735	---	---	---	---	---	776	10082	93.7					1555
		835	---	---	---	---	---	882	10087	94.2					1584
40	580	---	---	---	---	---	---	631	10389	91.9	1716	14.2	0.244	1378	
		645	---	---	---	---	---	698	10334	92.4					1401
		675	---	---	---	---	---	732	10356	92.7					1411
		770	---	---	---	---	---	834	10343	93.5					1438
41	540	---	---	---	---	---	---	593	10487	91.6	1618	15.6	0.317	1314	
		600	---	---	---	---	---	657	10457	92.3					1336
		625	---	---	---	---	---	689	10527	92.6					1346
		715	---	---	---	---	---	785	10484	93.3					1372
42	500	---	---	---	---	---	---	548	10466	91.3	1500	18.4	0.404	1332	
		555	---	---	---	---	---	607	10444	92.0					1357
		585	---	---	---	---	---	636	10382	92.2					1368
		665	---	---	---	---	---	725	10411	92.9					1397
43	465	---	---	---	---	---	---	534	10966	90.2	1480	21.7	0.379	1134	
		515	---	---	---	---	---	592	10977	90.9					1154
		545	---	---	---	---	---	622	10899	91.4					1163
		620	---	---	---	---	---	709	10920	92.1					1185
44	440	---	---	---	---	---	---	492	10678	90.0	1367	24.2	0.467	1080	
		485	---	---	---	---	---	546	10750	90.8					1099
		510	---	---	---	---	---	573	10729	91.1					1108
		585	---	---	---	---	---	654	10676	92.0					1129
45	415	---	---	---	---	---	---	475	10930	90.0	1320	24.8	0.547	1052	
		460	---	---	---	---	---	527	10940	90.7					1071
		485	---	---	---	---	---	554	10908	91.2					1079
		550	---	---	---	---	---	632	10973	92.1					1101
		---	---	---	---	---	---	640	10982	92.9	1320			1124	
		---	---	---	---	---	---	736	10982	92.9					1145
		---	---	---	---	---	---	755	10953	93.7					1145
		---	---	---	---	---	---	880	10949	94.4					1163

Nota (\*) - VENTILAZIONE SOLO L.O. / FAN ONLY SIDE COMMUTATOR

Nota (°) - Regolazione di campo / Field weakening



Potenza eccitazione Excitation power	(w)	8300	Tipo Size Ventilazione Ventilation	MGL C 400 P  IC 06
Cost. tempo eccitaz. Field time constant	(ms)	1400		
Massa del motore Mass of the motor	(Kg)	5000		
Momento d'inerzia rotore Rotor inertia moment	(Kgm2)	45.0		

Avv.	Velocità nominale n/min a tensione nominale di armatura Rated speed (rev/min) at rated voltage							Potenza Power kW	Coppia vel.nomin. Torque at rated speed Nm	Rendimento Efficiency %	Circuito di armatura Armature circuit			Max giri Max. speed (°)
	400	440	460	520	600	700	810				Corrente Current Amp	Res. 115°C mOhm	Ind. mH	
46	390	---	---	---	---	---	---	438	10725	89.5	1224	28.4	0.645	1005
		435	---	---	---	---	---	487	10691	90.4	1224			1024
		455	---	---	---	---	---	511	10725	90.8	1224			1032
		---	520	---	---	---	---	583	10706	91.6	1224			1053
		---	---	605	---	---	---	680	10733	92.6	1224			1075
		---	---	---	---	715	---	800	10685	93.4	1224			1096
		---	---	---	---	---	835	933	10670	94.1	1224			1114
		---	---	---	---	---	---	---	---	---	---			---
47	365	---	---	---	---	---	---	399	10439	88.3	1130	35.2	0.612	1085
		410	---	---	---	---	---	443	10318	89.1	1130			1109
		---	430	---	---	---	---	466	10349	89.6	1130			1119
		---	---	490	---	---	---	533	10387	90.7	1130			1146
		---	---	---	570	---	---	622	10421	91.7	1130			1174
		---	---	---	---	675	---	733	10370	92.7	1130			1200
		---	---	---	---	---	790	856	10347	93.5	1130			1223
		---	---	---	---	---	---	---	---	---	---			---
48	350	---	---	---	---	---	---	391	10668	88.4	1106	35.7	0.677	1047
		390	---	---	---	---	---	435	10651	89.4	1106			1070
		---	410	---	---	---	---	456	10621	89.6	1106			1080
		---	---	470	---	---	---	522	10606	90.8	1106			1106
		---	---	---	545	---	---	609	10671	91.8	1106			1133
		---	---	---	---	645	---	718	10630	92.7	1106			1159
		---	---	---	---	---	750	838	10670	93.5	1106			1181
		---	---	---	---	---	---	---	---	---	---			---
49	330	---	---	---	---	---	---	350	10128	87.5	1000	42.5	0.796	1109
		370	---	---	---	---	---	390	10066	88.6	1000			1137
		---	390	---	---	---	---	409	10015	88.9	1000			1149
		---	---	445	---	---	---	469	10064	90.2	1000			1180
		---	---	---	520	---	---	547	10045	91.2	1000			1213
		---	---	---	---	615	---	646	10031	92.3	1000			1245
		---	---	---	---	---	715	754	10070	93.1	1000			1272
		---	---	---	---	---	---	---	---	---	---			---
50	320	---	---	---	---	---	---	364	10862	87.5	1040	41.1	0.885	1169
		355	---	---	---	---	---	405	10894	88.5	1040			1201
		---	375	---	---	---	---	426	10848	89.0	1040			1215
		---	---	430	---	---	---	487	10815	90.1	1040			1252
		---	---	---	500	---	---	569	10867	91.2	1040			1290
		---	---	---	---	595	---	672	10785	92.3	1040			1327
		---	---	---	---	---	690	785	10864	93.2	1040			1359
		---	---	---	---	---	---	---	---	---	---			---
51	300	---	---	---	---	---	---	354	11268	87.6	1010	41.8	1.17	1019
		335	---	---	---	---	---	394	11231	88.7	1010			1044
		---	355	---	---	---	---	414	11136	89.1	1010			1055
		---	---	405	---	---	---	474	11176	90.3	1010			1084
		---	---	---	470	---	---	554	11256	91.4	1010			1115
		---	---	---	---	555	---	653	11236	92.4	1010			1145
		---	---	---	---	---	650	763	11209	93.3	1010			1169
		---	---	---	---	---	---	---	---	---	---			---
52	280	---	---	---	---	---	---	319	10879	86.3	924	51.7	1.10	973
		315	---	---	---	---	---	356	10792	87.6	924			998
		---	330	---	---	---	---	374	10823	88.0	924			1009
		---	---	375	---	---	---	428	10899	89.1	924			1038
		---	---	---	440	---	---	501	10873	90.4	924			1069
		---	---	---	---	520	---	592	10872	91.5	924			1098
		---	---	---	---	---	610	693	10849	92.6	924			1123
		---	---	---	---	---	---	---	---	---	---			---

Nota (\*) - VENTILAZIONE SOLO L.O. / FAN ONLY SIDE COMMUTATOR

Nota (°) - Regolazione di campo / Field weakening



Potenza eccitazione Excitation power (w) 8300	Tipo Size MGL C 400 P
Cost. tempo eccitaz. Field time constant (ms) 1400	Ventilazione Ventilation IC 06
Massa del motore Mass of the motor (Kg) 5000	
Momento d'inerzia rotore Rotor inertia moment (Kgm2) 45.0	

Avv.	Velocità nominale n/min a tensione nominale di armatura Rated speed (rev/min) at rated voltage							Potenza Power kW	Coppia vel.nomin. Torque at rated speed Nm	Rendimento Efficiency %	Circuito di armatura Armature circuit			Max giri Max. speed (°)
	400	440	460	520	600	700	810				Corrente Current Amp	Res. 115°C mOhm	Ind. mH	
53	263	---	---	---	---	---	---	310	11256	85.7	904	56.3	1.05	933
		293	---	---	---	---	---	345	11244	86.7	904			958
		---	310	---	---	---	---	363	11182	87.3	904			969
		---	---	355	---	---	---	417	11217	88.7	904			998
		---	---	---	415	---	---	488	11229	90.0	904			1028
		---	---	---	---	490	---	577	11245	91.2	904			1057
		---	---	---	---	---	575	675	11210	92.2	904			1082
		54	247	---	---	---	---	---	---	283	10941			84.7
276	---			---	---	---	---	316	10933	86.0	835	917		
---	290			---	---	---	---	332	10932	86.4	835	928		
---	---			335	---	---	---	382	10889	88.0	835	956		
---	---			---	390	---	---	447	10945	89.2	835	986		
---	---			---	---	465	---	530	10884	90.7	835	1015		
---	---			---	---	---	540	620	10964	91.7	835	1038		
55	234			---	---	---	---	---	---	260	10610	84.4	770	71.8
		262	---	---	---	---	---	290	10570	85.6	770	982		
		---	275	---	---	---	---	306	10626	86.4	770	995		
		---	---	315	---	---	---	351	10641	87.7	770	1029		
		---	---	---	370	---	---	412	10633	89.2	770	1066		
		---	---	---	---	440	---	488	10591	90.5	770	1101		
		---	---	---	---	---	515	571	10588	91.6	770	1131		
		56	232	---	---	---	---	---	---	258	10620	84.2	766	
259	---			---	---	---	---	288	10619	85.4	766	983		
---	272			---	---	---	---	303	10638	86.0	766	1035		
---	---			315	---	---	---	349	10580	87.6	766	1177		
---	---			---	365	---	---	409	10700	89.0	766	1226		
---	---			---	---	435	---	485	10647	90.5	766	1273		
---	---			---	---	---	510	568	10635	91.5	766	1313		
57	216			---	---	---	---	---	---	250	11052	83.8	746	78.7
		242	---	---	---	---	---	279	11009	85.0	746	918		
		---	254	---	---	---	---	294	11053	85.7	746	967		
		---	---	293	---	---	---	338	11016	87.1	746	1022		
		---	---	---	345	---	---	397	10989	88.7	746	1062		
		---	---	---	---	405	---	470	11082	90.0	746	1099		
		---	---	---	---	---	475	551	11077	91.2	746	1132		
		58	199	---	---	---	---	---	---	224	10749	82.0	683	
223	---			---	---	---	---	251	10748	83.5	683	849		
---	235			---	---	---	---	264	10728	84.0	683	895		
---	---			272	---	---	---	304	10673	85.6	683	975		
---	---			---	320	---	---	358	10683	87.4	683	1014		
---	---			---	---	380	---	426	10705	89.1	683	1052		
---	---			---	---	---	445	500	10730	90.4	683	1084		
59	188			---	---	---	---	---	---	215	10921	81.4	660	102
		211	---	---	---	---	---	241	10907	83.0	660	801		
		---	222	---	---	---	---	254	10926	83.7	660	844		
		---	---	256	---	---	---	294	10967	85.7	660	946		
		---	---	---	300	---	---	346	11014	87.4	660	985		
		---	---	---	---	360	---	411	10902	89.0	660	1023		
		---	---	---	---	---	420	482	10959	90.2	660	1054		

Nota (\*) - VENTILAZIONE SOLO L.O. / FAN ONLY SIDE COMMUTATOR

Nota (°) - Regolazione di campo / Field weakening



Potenza eccitazione Excitation power	(w)	8300	Tipo Size Ventilazione Ventilation	MGL C 400 P  IC 06
Cost. tempo eccitaz. Field time constant	(ms)	1400		
Massa del motore Mass of the motor	(Kg)	5000		
Momento d'inerzia rotore Rotor inertia moment	(Kgm2)	45.0		

Avv.	Velocità nominale n/min a tensione nominale di armatura Rated speed (rev/min) at rated voltage							Potenza Power kW	Coppia vel.nomin. Torque at rated speed Nm	Rendimento Efficiency %	Circuito di armatura Armature circuit			Max giri Max. speed (°)
	400	440	460	520	600	700	810				Corrente Current Amp	Res. 115°C mOhm	Ind. mH	
60	176	---	---	---	---	---	---	197	10689	80.5	612	116	2.57	670
		198	---	---	---	---	---	222	10707	82.4	612			752
		---	209	---	---	---	---	234	10692	83.1	612			793
		---	---	241	---	---	---	270	10698	84.8	612			902
		---	---	---	284	---	---	318	10693	86.6	612			940
		---	---	---	---	340	---	378	10617	88.2	612			977
		---	---	---	---	---	395	445	10758	89.8	612			1008
		---	---	---	---	---	---	---	---	---	---			---
61	166	---	---	---	---	---	---	180	10355	79.8	564	133	3.07	629
		186	---	---	---	---	---	202	10371	81.4	564			707
		---	196	---	---	---	---	213	10378	82.1	564			746
		---	---	227	---	---	---	246	10349	83.9	564			863
		---	---	---	268	---	---	291	10369	86.0	564			984
		---	---	---	---	320	---	346	10325	87.6	564			1027
		---	---	---	---	---	375	408	10390	89.3	564			1064
		---	---	---	---	---	---	---	---	---	---			---
62	155	---	---	---	---	---	---	172	10597	78.0	551	146	2.81	590
		175	---	---	---	---	---	194	10586	80.0	551			664
		---	185	---	---	---	---	205	10582	80.9	551			701
		---	---	214	---	---	---	238	10620	83.1	551			813
		---	---	---	253	---	---	281	10606	85.0	551			961
		---	---	---	---	300	---	335	10663	86.9	551			1007
		---	---	---	---	---	355	395	10625	88.5	551			1045
		---	---	---	---	---	---	---	---	---	---			---
63	144	---	---	---	---	---	---	164	10876	77.4	530	159	3.34	548
		163	---	---	---	---	---	185	10838	79.3	530			618
		---	172	---	---	---	---	195	10826	80.0	530			652
		---	---	199	---	---	---	227	10893	82.4	530			746
		---	---	---	236	---	---	268	10844	84.3	530			773
		---	---	---	---	282	---	321	10870	86.5	530			798
		---	---	---	---	---	335	378	10775	88.1	530			818
		---	---	---	---	---	---	---	---	---	---			---
64	135	---	---	---	---	---	---	158	11176	77.3	511	164	4.33	515
		153	---	---	---	---	---	179	11172	79.6	511			580
		---	161	---	---	---	---	189	11210	80.4	511			613
		---	---	187	---	---	---	219	11183	82.4	511			650
		---	---	---	222	---	---	259	11141	84.5	511			672
		---	---	---	---	265	---	310	11171	86.7	511			692
		---	---	---	---	---	310	365	11244	88.2	511			708
		---	---	---	---	---	---	---	---	---	---			---
65	123	---	---	---	---	---	---	139	10792	74.3	468	205	4.31	466
		139	---	---	---	---	---	158	10855	76.7	468			528
		---	147	---	---	---	---	167	10849	77.6	468			559
		---	---	171	---	---	---	195	10890	80.1	468			619
		---	---	---	204	---	---	232	10860	82.6	468			641
		---	---	---	---	245	---	278	10836	84.9	468			661
		---	---	---	---	---	289	329	10871	86.8	468			678
		---	---	---	---	---	---	---	---	---	---			---
66	113	---	---	---	---	---	---	133	11239	73.1	455	225	4.30	431
		129	---	---	---	---	---	151	11178	75.4	455			490
		---	136	---	---	---	---	160	11235	76.4	455			519
		---	---	160	---	---	---	186	11101	78.6	455			596
		---	---	---	190	---	---	222	11158	81.3	455			618
		---	---	---	---	229	---	267	11134	83.8	455			639
		---	---	---	---	---	---	271	11170	86.0	455			655
		---	---	---	---	---	---	---	---	---	---			---

Nota (\*) - VENTILAZIONE SOLO L.O. / FAN ONLY SIDE COMMUTATOR

Nota (°) - Regolazione di campo / Field weakening



Potenza eccitazione  
Excitation power (w) 8300  
Cost. tempo eccitaz.  
Field time constant (ms) 1400  
Massa del motore  
Mass of the motor (Kg) 5000  
Momento d'inerzia rotore  
Rotor inertia moment (Kgm2) 45.0

Tipo  
Size MGL C 400 P  
Ventilazione  
Ventilation IC 06

Avv.	Velocità nominale n/min a tensione nominale di armatura Rated speed (rev/min) at rated voltage							Potenza Power kW	Coppia vel.nomin. Torque at rated speed Nm	Rendimento Efficiency %	Circuito di armatura Armature circuit			Max giri Max. speed (°)	
	400	440	460	520	600	700	810				Corrente Current Amp	Res. 115°C mOhm	Ind. mH		
67	106	---	---	---	---	---	---	121	10901	72.0	420	253	5.17	403	
		121	---	---	---	---	---	137	10812	74.1					459
		---	128	---	---	---	---	146	10892	75.6					486
		---	---	150	---	---	---	170	10823	77.8					569
		---	---	---	179	---	---	204	10883	81.0					592
		---	---	---	---	215	---	245	10882	83.3					613
		---	---	---	---	---	255	291	10897	85.5					629
68	99	---	---	---	---	---	---	109	10514	70.4	387	292	6.11	375	
		113	---	---	---	---	---	124	10479	72.8					428
		---	119	---	---	---	---	132	10593	74.1					454
		---	---	140	---	---	---	155	10572	77.0					533
		---	---	---	168	---	---	185	10516	79.7					638
		---	---	---	---	203	---	223	10490	82.3					671
		---	---	---	---	---	241	265	10500	84.5					692
69	94	---	---	---	---	---	---	106	10768	70.1	378	298	7.22	357	
		107	---	---	---	---	---	121	10799	72.8					408
		---	114	---	---	---	---	129	10806	74.2					433
		---	---	134	---	---	---	151	10761	76.8					508
		---	---	---	160	---	---	181	10803	79.8					608
		---	---	---	---	193	---	218	10786	82.4					636
		---	---	---	---	---	229	259	10800	84.6					656
70	84	---	---	---	---	---	---	86.6	9845	65.6	330	398	6.35	319	
		97	---	---	---	---	---	99.7	9815	68.7					367
		---	103	---	---	---	---	106	9827	69.8					391
		---	---	122	---	---	---	126	9862	73.4					463
		---	---	---	147	---	---	152	9874	76.8					558
		---	---	---	---	178	---	184	9871	79.7					678
		---	---	---	---	---	213	220	9863	82.3					723

Nota (\*) - VENTILAZIONE SOLO L.O. / FAN ONLY SIDE COMMUTATOR

Nota (°) - Regolazione di campo / Field weakening





Potenza eccitazione Excitation power	(w)	9500	Tipo Size MGL C 400 X Ventilazione Ventilation IC 06
Cost. tempo eccitaz. Field time constant	(ms)	1500	
Massa del motore Mass of the motor	(Kg)	5400	
Momento d'inerzia rotore Rotor inertia moment	(Kgm2)	49.2	

Avv.	Velocità nominale n/min a tensione nominale di armatura Rated speed (rev/min) at rated voltage							Potenza Power kW	Coppia vel.nomin. Torque at rated speed Nm	Rendimento Efficiency %	Circuito di armatura Armature circuit			Max giri Max. speed (°)	
	400	440	460	520	600	700	810				Corrente Current Amp	Res. 115°C mOhm	Ind. mH		
39	570	---	---	---	---	---	---	668	11191	92.8	1800	11.8	0.330	1417 1442 1452 1481 1510	
		630	---	---	---	---	---	739	11202	93.3	1800				
		660	---	---	---	---	---	774	11199	93.5	1800				
		750	---	---	---	---	---	881	11217	94.1	1800				
40	520	---	---	---	---	---	---	628	11533	91.5	1716	15.2	0.268	1283 1305 1315 1340 1367	
		575	---	---	---	---	---	696	11559	92.2	1716				
		605	---	---	---	---	---	730	11522	92.5	1716				
		690	---	---	---	---	---	832	11515	93.2	1716				
		800	---	---	---	---	---	967	11543	93.9	1716				
41	485	---	---	---	---	---	---	591	11636	91.3	1618	16.7	0.350	1221 1243 1253 1278 1304	
		535	---	---	---	---	---	655	11691	92.0	1618				
		560	---	---	---	---	---	687	11715	92.3	1618				
		640	---	---	---	---	---	783	11683	93.1	1618				
		745	---	---	---	---	---	911	11677	93.8	1618				
42	450	---	---	---	---	---	---	545	11565	90.8	1500	19.7	0.446	1238 1263 1273 1301 1330 1358	
		500	---	---	---	---	---	604	11536	91.5	1500				
		525	---	---	---	---	---	634	11532	91.9	1500				
		595	---	---	---	---	---	723	11604	92.7	1500				
		695	---	---	---	---	---	841	11555	93.4	1500				
		815	---	---	---	---	---	989	11588	94.2	1500				
43	415	---	---	---	---	---	---	531	12219	89.7	1480	23.2	0.417	1051 1070 1078 1100 1122 1144	
		465	---	---	---	---	---	590	12116	90.6	1480				
		485	---	---	---	---	---	619	12188	90.9	1480				
		555	---	---	---	---	---	707	12165	91.9	1480				
		645	---	---	---	---	---	823	12185	92.7	1480				
		760	---	---	---	---	---	970	12188	93.6	1480				
		---	---	---	---	---	---	---	---	---	---				---
44	390	---	---	---	---	---	---	489	11973	89.4	1367	25.8	0.515	998 1017 1025 1045 1067 1088 1105	
		435	---	---	---	---	---	543	11920	90.3	1367				
		455	---	---	---	---	---	570	11963	90.6	1367				
		520	---	---	---	---	---	651	11955	91.6	1367				
		610	---	---	---	---	---	759	11882	92.5	1367				
		715	---	---	---	---	---	894	11940	93.4	1367				
		835	---	---	---	---	---	1042	11917	94.1	1367				
		---	---	---	---	---	---	---	---	---	---				---
45	370	---	---	---	---	---	---	473	12208	89.6	1320	26.6	0.603	972 990 998 1019 1041 1062 1079	
		410	---	---	---	---	---	525	12228	90.4	1320				
		435	---	---	---	---	---	551	12096	90.7	1320				
		495	---	---	---	---	---	629	12134	91.6	1320				
		575	---	---	---	---	---	733	12173	92.6	1320				
		680	---	---	---	---	---	864	12133	93.5	1320				
		790	---	---	---	---	---	1007	12172	94.2	1320				
		---	---	---	---	---	---	---	---	---	---				---
		---	---	---	---	---	---	---	---	---	---				---

Nota (\*) - VENTILAZIONE SOLO L.O. / FAN ONLY SIDE COMMUTATOR

Nota (°) - Regolazione di campo / Field weakening



Potenza eccitazione Excitation power (w)	9500	Tipo Size	MGL C 400 X
Cost. tempo eccitaz. Field time constant (ms)	1500	Ventilazione Ventilation	IC 06
Massa del motore Mass of the motor (Kg)	5400		
Momento d'inerzia rotore Rotor inertia moment (Kgm2)	49.2		

Avv.	Velocità nominale n/min a tensione nominale di armatura Rated speed (rev/min) at rated voltage							Potenza Power kW	Coppia vel.nomin. Torque at rated speed Nm	Rendimento Efficiency %	Circuito di armatura Armature circuit			Max giri Max. speed (°)
	400	440	460	520	600	700	810				Corrente Current Amp	Res. 115°C mOhm	Ind. mH	
46	350	---	---	---	---	---	---	436	11896	89.1	1224	30.4	0.711	927
		390	---	---	---	---	---	484	11851	89.9	1224			945
		410	---	---	---	---	---	508	11832	90.2	1224			953
		465	---	---	---	---	---	581	11932	91.3	1224			973
		545	---	---	---	---	---	677	11862	92.2	1224			994
		640	---	---	---	---	---	798	11907	93.1	1224			1014
		750	---	---	---	---	---	931	11854	93.9	1224			1031
47	330	---	---	---	---	---	---	396	11459	87.6	1130	37.7	0.674	1001
		365	---	---	---	---	---	441	11538	88.7	1130			1024
		385	---	---	---	---	---	463	11484	89.1	1130			1034
		440	---	---	---	---	---	530	11503	90.2	1130			1060
		515	---	---	---	---	---	619	11478	91.3	1130			1087
		605	---	---	---	---	---	731	11538	92.4	1130			1112
		705	---	---	---	---	---	853	11554	93.2	1130			1134
48	315	---	---	---	---	---	---	388	11762	87.7	1106	38.2	0.745	966
		350	---	---	---	---	---	432	11787	88.8	1106			988
		365	---	---	---	---	---	454	11878	89.2	1106			998
		420	---	---	---	---	---	519	11800	90.2	1106			1023
		490	---	---	---	---	---	607	11829	91.5	1106			1049
		575	---	---	---	---	---	716	11891	92.5	1106			1074
		675	---	---	---	---	---	836	11827	93.3	1106			1095
49	296	---	---	---	---	---	---	348	11227	87.0	1000	45.5	0.877	1023
		330	---	---	---	---	---	387	11199	88.0	1000			1050
		345	---	---	---	---	---	407	11265	88.5	1000			1061
		395	---	---	---	---	---	466	11266	89.6	1000			1092
		465	---	---	---	---	---	545	11192	90.8	1000			1123
		550	---	---	---	---	---	644	11181	92.0	1000			1154
		640	---	---	---	---	---	752	11220	92.8	1000			1180
50	287	---	---	---	---	---	---	362	12045	87.0	1040	44.0	0.976	1082
		320	---	---	---	---	---	403	12026	88.1	1040			1113
		335	---	---	---	---	---	423	12058	88.4	1040			1127
		385	---	---	---	---	---	485	12030	89.7	1040			1162
		450	---	---	---	---	---	567	12032	90.9	1040			1200
		530	---	---	---	---	---	670	12072	92.0	1040			1236
		620	---	---	---	---	---	782	12044	92.8	1040			1266
51	270	---	---	---	---	---	---	352	12450	87.1	1010	44.7	1.29	940
		300	---	---	---	---	---	392	12478	88.2	1010			965
		315	---	---	---	---	---	412	12490	88.7	1010			975
		360	---	---	---	---	---	471	12494	89.7	1010			1003
		425	---	---	---	---	---	551	12380	90.9	1010			1033
		500	---	---	---	---	---	651	12433	92.1	1010			1061
		585	---	---	---	---	---	761	12422	93.0	1010			1085
52	250	---	---	---	---	---	---	316	12070	85.5	924	55.3	1.21	896
		279	---	---	---	---	---	353	12082	86.8	924			920
		293	---	---	---	---	---	371	12091	87.3	924			931
		335	---	---	---	---	---	426	12143	88.7	924			959
		395	---	---	---	---	---	499	12064	90.0	924			988
		465	---	---	---	---	---	590	12116	91.2	924			1016
		545	---	---	---	---	---	690	12090	92.2	924			1040

Nota (\*) - VENTILAZIONE SOLO L.O. / FAN ONLY SIDE COMMUTATOR

Nota (°) - Regolazione di campo / Field weakening



Potenza eccitazione Excitation power	(w)	9500	Tipo Size Ventilazione Ventilation	MGL C 400 X  IC 06
Cost. tempo eccitaz. Field time constant	(ms)	1500		
Massa del motore Mass of the motor	(Kg)	5400		
Momento d'inerzia rotore Rotor inertia moment	(Kgm2)	49.2		

Avv.	Velocità nominale n/min a tensione nominale di armatura Rated speed (rev/min) at rated voltage							Potenza Power kW	Coppia vel.nomin. Torque at rated speed Nm	Rendimento Efficiency %	Circuito di armatura Armature circuit			Max giri Max. speed (°)
	400	440	460	520	600	700	810				Corrente Current Amp	Res. 115°C mOhm	Ind. mH	
53	234	---	---	---	---	---	---	307	12528	84.9	904	60.1	1.16	859
		262	---	---	---	---	---	342	12465	86.0	904			883
		---	275	---	---	---	---	360	12501	86.6	904			894
		---	---	315	---	---	---	414	12551	88.1	904			921
		---	---	---	370	---	---	485	12517	89.4	904			950
		---	---	---	---	440	---	574	12458	90.7	904			978
		---	---	---	---	---	515	673	12479	91.9	904			1002
54	220	---	---	---	---	---	---	280	12154	83.8	835	69.9	1.53	820
		246	---	---	---	---	---	313	12150	85.2	835			843
		---	259	---	---	---	---	329	12130	85.7	835			854
		---	---	297	---	---	---	379	12186	87.3	835			881
		---	---	---	350	---	---	445	12141	88.8	835			910
		---	---	---	---	415	---	527	12127	90.2	835			937
		---	---	---	---	---	485	618	12168	91.4	835			960
55	209	---	---	---	---	---	---	257	11742	83.4	770	76.8	1.72	792
		233	---	---	---	---	---	288	11803	85.0	770			886
		---	245	---	---	---	---	303	11810	85.5	770			916
		---	---	282	---	---	---	349	11818	87.2	770			949
		---	---	---	330	---	---	409	11835	88.5	770			984
		---	---	---	---	395	---	485	11725	90.0	770			1018
		---	---	---	---	---	460	569	11812	91.2	770			1046
56	206	---	---	---	---	---	---	255	11821	83.2	766	78.9	1.78	783
		230	---	---	---	---	---	285	11833	84.6	766			876
		---	243	---	---	---	---	301	11829	85.4	766			922
		---	---	279	---	---	---	346	11843	86.9	766			1061
		---	---	---	330	---	---	406	11749	88.3	766			1136
		---	---	---	---	390	---	482	11802	89.9	766			1182
		---	---	---	---	---	455	565	11858	91.1	766			1221
57	192	---	---	---	---	---	---	247	12285	82.8	746	84.3	2.35	730
		215	---	---	---	---	---	276	12259	84.1	746			817
		---	227	---	---	---	---	291	12242	84.8	746			861
		---	---	261	---	---	---	335	12257	86.4	746			943
		---	---	---	305	---	---	394	12336	88.0	746			981
		---	---	---	---	365	---	468	12244	89.6	746			1017
		---	---	---	---	---	425	549	12335	90.9	746			1048
58	177	---	---	---	---	---	---	221	11923	80.9	683	103	2.06	673
		199	---	---	---	---	---	248	11901	82.5	683			755
		---	209	---	---	---	---	261	11925	83.1	683			796
		---	---	242	---	---	---	302	11917	85.0	683			897
		---	---	---	285	---	---	356	11928	86.9	683			935
		---	---	---	---	340	---	423	11881	88.5	683			971
		---	---	---	---	---	400	497	11865	89.8	683			1002
59	167	---	---	---	---	---	---	213	12180	80.7	660	109	2.50	634
		187	---	---	---	---	---	239	12205	82.3	660			712
		---	198	---	---	---	---	252	12154	83.0	660			751
		---	---	228	---	---	---	291	12188	84.8	660			867
		---	---	---	269	---	---	343	12176	86.6	660			907
		---	---	---	---	320	---	408	12175	88.3	660			944
		---	---	---	---	---	375	480	12223	89.8	660			974

Nota (\*) - VENTILAZIONE SOLO L.O. / FAN ONLY SIDE COMMUTATOR

Nota (°) - Regolazione di campo / Field weakening



Potenza eccitazione Excitation power	(w)	9500	Tipo Size	MGL C 400 X
Cost. tempo eccitaz. Field time constant	(ms)	1500	Ventilazione Ventilation	IC 06
Massa del motore Mass of the motor	(Kg)	5400		
Momento d'inerzia rotore Rotor inertia moment	(Kgm2)	49.2		

Avv.	Velocità nominale n/min a tensione nominale di armatura Rated speed (rev/min) at rated voltage							Potenza Power kW	Coppia vel.nomin. Torque at rated speed Nm	Rendimento Efficiency %	Circuito di armatura Armature circuit			Max giri Max. speed (°)	
	400	440	460	520	600	700	810				Corrente Current Amp	Res. 115°C mOhm	Ind. mH		
60	156	---	---	---	---	---	---	195	11937	79.7	612	124	2.83	594	
		176	---	---	---	---	---	219	11882	81.3					668
		---	185	---	---	---	---	231	11924	82.1					705
		---	---	215	---	---	---	267	11859	83.9					815
		---	---	---	253	---	---	315	11889	85.8					865
		---	---	---	---	300	---	376	11969	87.8					900
		---	---	---	---	---	355	442	11890	89.2					930
		---	---	---	---	---	---	---	---	---					---
61	147	---	---	---	---	---	---	177	11498	78.5	564	142	3.39	557	
		165	---	---	---	---	---	199	11517	80.2					627
		---	174	---	---	---	---	210	11525	80.9					662
		---	---	202	---	---	---	244	11535	83.2					768
		---	---	---	239	---	---	288	11507	85.1					905
		---	---	---	---	285	---	344	11526	87.1					947
		---	---	---	---	---	335	405	11545	88.7					982
		---	---	---	---	---	---	---	---	---					---
62	137	---	---	---	---	---	---	170	11850	77.1	551	156	3.10	521	
		155	---	---	---	---	---	191	11767	78.8					588
		---	164	---	---	---	---	202	11762	79.7					622
		---	---	190	---	---	---	235	11811	82.0					722
		---	---	---	225	---	---	278	11799	84.1					856
		---	---	---	---	269	---	333	11821	86.3					928
		---	---	---	---	---	320	392	11698	87.8					964
		---	---	---	---	---	---	---	---	---					---
63	127	---	---	---	---	---	---	161	12106	75.9	530	170	3.69	484	
		144	---	---	---	---	---	182	12069	78.0					547
		---	152	---	---	---	---	192	12062	78.8					578
		---	---	177	---	---	---	224	12085	81.3					672
		---	---	---	210	---	---	266	12096	83.6					717
		---	---	---	---	251	---	318	12098	85.7					742
		---	---	---	---	---	297	376	12089	87.6					762
		---	---	---	---	---	---	---	---	---					---
64	120	---	---	---	---	---	---	156	12414	76.3	511	175	4.78	455	
		135	---	---	---	---	---	176	12450	78.3					514
		---	143	---	---	---	---	186	12421	79.1					543
		---	---	166	---	---	---	216	12426	81.3					601
		---	---	---	197	---	---	256	12409	83.5					621
		---	---	---	---	236	---	307	12422	85.8					641
		---	---	---	---	---	279	362	12390	87.5					657
		---	---	---	---	---	---	---	---	---					---
65	108	---	---	---	---	---	---	136	12025	72.6	468	220	4.75	410	
		123	---	---	---	---	---	155	12034	75.3					466
		---	130	---	---	---	---	164	12047	76.2					494
		---	---	152	---	---	---	192	12062	78.9					570
		---	---	---	181	---	---	229	12082	81.6					591
		---	---	---	---	218	---	275	12046	83.9					611
		---	---	---	---	---	258	326	12066	86.0					627
		---	---	---	---	---	---	---	---	---					---
66	100	---	---	---	---	---	---	130	12414	71.4	455	241	4.73	379	
		113	---	---	---	---	---	147	12423	73.4					431
		---	120	---	---	---	---	156	12414	74.5					458
		---	---	141	---	---	---	183	12394	77.3					536
		---	---	---	169	---	---	219	12375	80.2					570
		---	---	---	---	203	---	264	12419	82.9					590
		---	---	---	---	---	---	241	12442	85.2					606
		---	---	---	---	---	---	---	---	---					---

Nota (\*) - VENTILAZIONE SOLO L.O. / FAN ONLY SIDE COMMUTATOR

Nota (°) - Regolazione di campo / Field weakening



Potenza eccitazione Excitation power	(w)	9500	Tipo Size Ventilazione Ventilation	MGL C 400 X  IC 06
Cost. tempo eccitaz. Field time constant	(ms)	1500		
Massa del motore Mass of the motor	(Kg)	5400		
Momento d'inerzia rotore Rotor inertia moment	(Kgm2)	49.2		

Avv.	Velocità nominale n/min a tensione nominale di armatura Rated speed (rev/min) at rated voltage							Potenza Power kW	Coppia vel.nomin. Torque at rated speed Nm	Rendimento Efficiency %	Circuito di armatura Armature circuit			Max giri Max. speed (°)	
	400	440	460	520	600	700	810				Corrente Current Amp	Res. 115°C mOhm	Ind. mH		
67	93	---	---	---	---	---	---	118	12116	70.2	420	271	5.70	354	
		106	---	---	---	---	---	134	12072	72.5					404
		113	---	---	---	---	---	143	12085	74.0					429
		132	---	---	---	---	---	168	12154	76.9					503
		159	---	---	---	---	---	201	12072	79.8					545
		191	---	---	---	---	---	242	12099	82.3					565
		227	---	---	---	---	---	288	12115	84.7					581
68	86	---	---	---	---	---	---	106	11770	68.5	387	312	6.73	328	
		99	---	---	---	---	---	121	11671	71.1					375
		105	---	---	---	---	---	129	11732	72.5					399
		124	---	---	---	---	---	152	11706	75.5					470
		149	---	---	---	---	---	182	11664	78.4					565
		180	---	---	---	---	---	220	11671	81.2					619
		214	---	---	---	---	---	262	11691	83.6					640
69	82	---	---	---	---	---	---	103	11995	68.1	378	319	7.96	313	
		94	---	---	---	---	---	118	11987	70.9					358
		100	---	---	---	---	---	126	12032	72.5					381
		118	---	---	---	---	---	148	11977	75.3					448
		142	---	---	---	---	---	178	11970	78.5					539
		171	---	---	---	---	---	215	12007	81.3					587
		204	---	---	---	---	---	256	11983	83.6					606
70	84	---	---	---	---	---	---	96.8	11004	66.7	330	426	6.99	320	
		90	---	---	---	---	---	103	10929	67.9					342
		107	---	---	---	---	---	123	10977	71.7					407
		130	---	---	---	---	---	149	10945	75.3					493
		158	---	---	---	---	---	181	10939	78.4					601
		189	---	---	---	---	---	217	10964	81.2					667

Nota (\*) - VENTILAZIONE SOLO L.O. / FAN ONLY SIDE COMMUTATOR

Nota (°) - Regolazione di campo / Field weakening



**MOTORI C.C. SERIE MGLC - D.C. MOTORS SERIES MGLC**

Forma costr. IM B3 e derivate - Mounting IM B3 and derived

Protezione IP23S - Protection IP23S

Ventilazione IC06 - Cooling IC06

**MGLC 315 - 400**

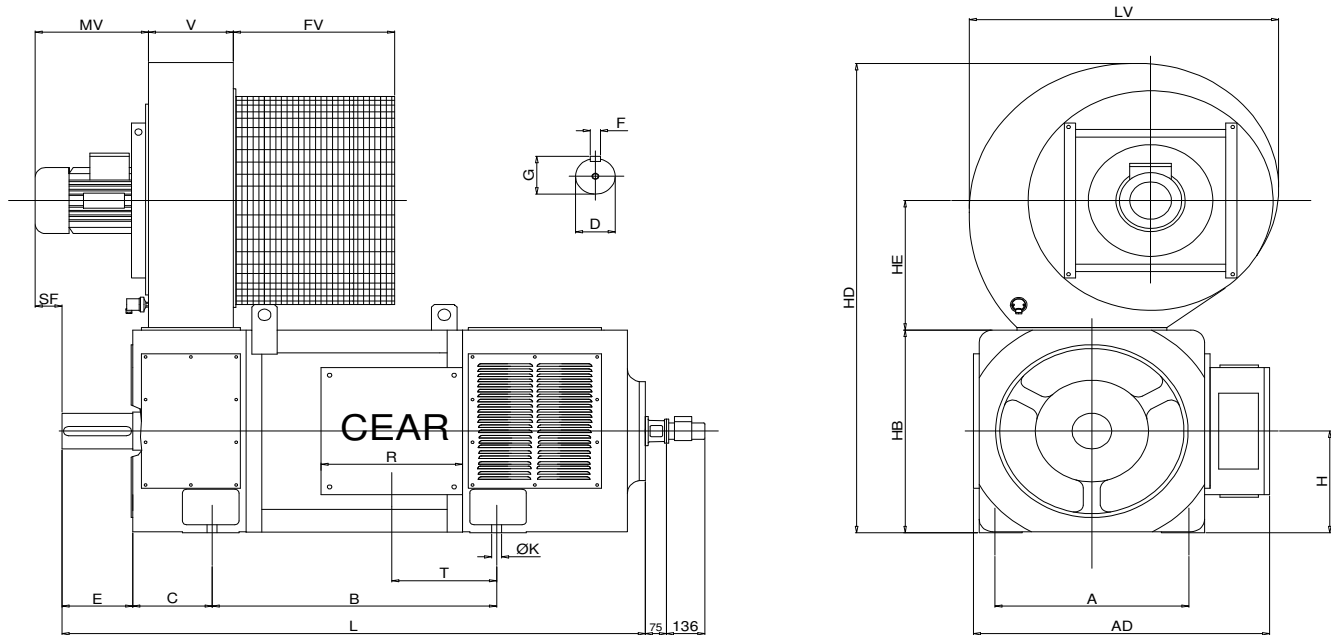

TYPE	SIZE	PIAZZAMENTO					INGOMBRO				ELETTOVENTILATORE					
		A	B	C	H	K	HD	HB	L	AD	FV	MV	V	SF	LV	HE
315	K	508	710	190	315	28	1590	628	1560	887	420	325	210	73	970	460
	S		765						1615							
	M		830						1680							
	L		910						1760							
	P		1010						1860							
	X		1070						1920							
400	K	686	785	280	400	35	1850	798	1840	1046	570	400	300	95	1093	510
	S		855						1910							
	M		935						1990							
	L		1035						2090							
	P		1155						2210							
	X		1235						2290							

TYPE	ALBERO				MORSETTIERA	
	E	D	F	G	R	T
315	210	120	32	127	500	350
400	250	140	36	148	500	370



Potenza eccitazione Excitation power	(w)	4600	Tipo Size Ventilazione Ventilation	MGL C 500 K  IC 06
Cost. tempo eccitaz. Field time constant	(ms)	1080		
Massa del motore Mass of the motor	(Kg)	5645		
Momento d'inerzia rotore Rotor inertia moment	(Kgm2)	60		

Avv.	Velocità nominale n/min a tensione nominale di armatura Rated speed (rev/min) at rated voltage							Potenza Power kW	Coppia vel.nomin. Torque at rated speed Nm	Rendimento Efficiency %	Circuito di armatura Armature circuit			Max giri Max. speed (°)	*
	400	440	460	520	600	700	810				Corrente Current Amp	Res. 115°C mOhm	Ind. mH		
41	1395	---	---	---	---	---	---	1003	6866	94.5	2653	4.34	0.067	1574	*
		1535	---	---	---	---	---	1079	6713	94.8	2586			1628	*
		1600	---	---	---	---	---	1115	6655	94.9	2553			1656	*
42	1235	---	---	---	---	---	---	999	7725	94.4	2647	5.60	0.082	1484	*
		1365	---	---	---	---	---	1076	7528	94.8	2580			1531	*
		1430	---	---	---	---	---	1112	7426	94.9	2547			1555	*
		1615	---	---	---	---	---	1236	7308	95.1	2500			1580	*
43	1085	---	---	---	---	---	---	889	7824	94.3	2357	5.27	0.099	1481	*
		1200	---	---	---	---	---	959	7632	94.6	2304			1529	*
		1255	---	---	---	---	---	993	7556	94.8	2277			1553	*
		1425	---	---	---	---	---	1087	7284	95.1	2198			1626	*
		1650	---	---	---	---	---	1199	6939	95.6	2091			1727	*
44	1025	---	---	---	---	---	---	844	7863	94.0	2244	5.92	0.114	1530	*
		1130	---	---	---	---	---	931	7868	94.3	2243			1547	*
		1185	---	---	---	---	---	964	7768	94.5	2217			1572	*
		1345	---	---	---	---	---	1056	7497	95.0	2138			1649	*
		1560	---	---	---	---	---	1163	7119	95.4	2032			1754	*
45	970	---	---	---	---	---	---	801	7886	94.0	2130	6.28	0.142	1349	*
		1075	---	---	---	---	---	883	7844	94.3	2128			1363	*
		1125	---	---	---	---	---	914	7758	94.5	2103			1385	*
		1275	---	---	---	---	---	1001	7497	94.9	2028			1451	*
		1480	---	---	---	---	---	1103	7117	95.3	1928			1542	*
46	915	---	---	---	---	---	---	715	7462	93.1	1920	10.2	0.11	1553	*
		1010	---	---	---	---	---	790	7469	93.5	1920			1571	*
		1060	---	---	---	---	---	828	7459	93.8	1920			1579	*
		1205	---	---	---	---	---	941	7457	94.3	1920			1600	*
		1395	---	---	---	---	---	1093	7482	94.9	1920			1704	*
		1640	---	---	---	---	---	1282	7465	95.4	1920			1800	*
47	845	---	---	---	---	---	---	738	8340	93.4	1976	9.60	0.122	1510	*
		935	---	---	---	---	---	816	8334	93.9	1976			1528	*
		980	---	---	---	---	---	855	8331	94.1	1976			1535	*
		1115	---	---	---	---	---	972	8325	94.6	1976			1554	*
		1295	---	---	---	---	---	1128	8318	95.1	1976			1575	*
		1515	---	---	---	---	---	1323	8339	95.6	1976			1596	*

Nota (\*) - VENTILAZIONE SOLO L.O. / FAN ONLY SIDE COMMUTATOR

Nota (°) - Regolazione di campo / Field weakening





Potenza eccitazione Excitation power (w)	4600	Tipo Size	MGL C 500 K
Cost. tempo eccitaz. Field time constant (ms)	1080	Ventilazione Ventilation	IC 06
Massa del motore Mass of the motor (Kg)	5645		
Momento d'inerzia rotore Rotor inertia moment (Kgm2)	60		

Avv.	Velocità nominale n/min a tensione nominale di armatura Rated speed (rev/min) at rated voltage							Potenza Power kW	Coppia vel.nomin. Torque at rated speed Nm	Rendimento Efficiency %	Circuito di armatura Armature circuit			Max giri Max. speed (°)	
	400	440	460	520	600	700	810				Corrente Current Amp	Res. 115°C mOhm	Ind. mH		
48	830	---	---	---	---	---	---	688	7916	93.1	1848	9.23	0.153	1460	*
		920	---	---	---	---	---	760	7889	93.5	1848			1477	
		---	970	---	---	---	---	797	7846	93.8	1848			1485	
		---	---	1105	---	---	---	905	7821	94.2	1848			1504	
		---	---	---	1280	---	---	1050	7833	94.7	1848			1525	
		---	---	---	---	1500	---	1230	7834	95.1	1848			1546	
49	805	---	---	---	---	---	---	662	7853	93.0	1779	9.7	0.18	1423	*
		890	---	---	---	---	---	732	7854	93.5	1779			1441	
		---	930	---	---	---	---	767	7876	93.7	1779			1448	
		---	---	1055	---	---	---	871	7884	94.2	1779			1468	
		---	---	---	1225	---	---	1011	7881	94.7	1779			1488	
		---	---	---	---	1435	---	1184	7881	95.1	1779			1508	
50	755	---	---	---	---	---	---	622	7867	92.4	1683	11.7	0.166	1367	
		835	---	---	---	---	---	688	7868	92.9	1683			1384	
		---	875	---	---	---	---	721	7869	93.1	1683			1392	
		---	---	995	---	---	---	820	7870	93.7	1683			1411	
		---	---	---	1155	---	---	952	7871	94.3	1683			1431	
		---	---	---	---	1354	---	1116	7871	94.7	1683			1451	
51	715	---	---	---	---	---	---	589	7867	92.3	1596	12.8	0.193	1304	
		790	---	---	---	---	---	652	7881	92.8	1596			1320	
		---	830	---	---	---	---	683	7858	93.0	1596			1327	
		---	---	945	---	---	---	777	7852	93.6	1596			1346	
		---	---	---	1095	---	---	902	7866	94.2	1596			1365	
		---	---	---	---	1284	---	1058	7866	94.7	1596			1384	
52	685	---	---	---	---	---	---	514	7166	92.3	1392	16.4	0.227	1394	
		760	---	---	---	---	---	568	7137	92.7	1392			1414	
		---	795	---	---	---	---	596	7159	93.1	1392			1423	
		---	---	905	---	---	---	678	7154	93.7	1392			1446	
		---	---	---	1050	---	---	788	7167	94.3	1392			1469	
		---	---	---	---	1230	---	925	7181	94.9	1392			1492	
53	630	---	---	---	---	---	---	518	7852	91.2	1420	19.7	0.27	1505	*
		700	---	---	---	---	---	575	7844	92.0	1420			1529	
		---	735	---	---	---	---	603	7834	92.3	1420			1540	
		---	---	835	---	---	---	689	7880	93.3	1420			1568	
		---	---	---	975	---	---	799	7826	93.8	1420			1598	
		---	---	---	---	1145	---	939	7826	94.4	1420			1629	
54	595	---	---	---	---	---	---	490	7864	91.6	1338	17.5	0.282	1423	*
		660	---	---	---	---	---	543	7857	92.2	1338			1447	
		---	690	---	---	---	---	569	7875	92.4	1338			1457	
		---	---	785	---	---	---	648	7883	93.1	1338			1485	
		---	---	---	915	---	---	753	7859	93.8	1338			1513	
		---	---	---	---	1074	---	884	7859	94.3	1338			1542	
								1248	1027	94.8	1338			1573	

Nota (\*) - VENTILAZIONE SOLO L.O. / FAN ONLY SIDE COMMUTATOR

Nota (°) - Regolazione di campo / Field weakening



Potenza eccitazione Excitation power	(w)	4600	Tipo Size Ventilazione Ventilation	MGL C 500 K  IC 06
Cost. tempo eccitaz. Field time constant	(ms)	1080		
Massa del motore Mass of the motor	(Kg)	5645		
Momento d'inerzia rotore Rotor inertia moment	(Kgm2)	60		

Avv.	Velocità nominale n/min a tensione nominale di armatura Rated speed (rev/min) at rated voltage							Potenza Power kW	Coppia vel.nomin. Torque at rated speed Nm	Rendimento Efficiency %	Circuito di armatura Armature circuit			Max giri Max. speed (°)	
	400	440	460	520	600	700	810				Corrente Current Amp	Res. 115°C mOhm	Ind. mH		
55	530	---	---	---	---	---	---	456	8216	90.5	1260	24.5	0.346	1346	
		590	---	---	---	---	---	506	8190	91.3	1260			1369	
		620	---	---	---	---	---	---	531	8179	91.6			1260	1379
			710	---	---	---	---	---	606	8151	92.5			1260	1405
		825	---	---	---	---	---	---	705	8160	93.3			1260	1432
			970	---	---	---	---	---	830	8171	94.1			1260	1460
		1130	---	---	---	---	---	---	966	8160	94.6			1260	1435
		56	525	---	---	---	---	---	---	433	7876			91.1	1188
580	---			---	---	---	---	480	7903	91.8	1188	1356			
610	---			---	---	---	---	---	503	7874	92.0	1188	1366		
	695			---	---	---	---	---	573	7873	92.8	1188	1393		
805	---			---	---	---	---	---	666	7900	93.4	1188	1422		
	945			---	---	---	---	---	782	7901	94.0	1188	1452		
1099	---			---	---	---	---	---	909	7900	94.5	1188	1484		
57	490			---	---	---	---	---	---	393	7659	89.0	1104	32.8	0.475
		545	---	---	---	---	---	436	7639	89.8	1104	1400			
		570	---	---	---	---	---	---	458	7673	90.2	1104	1412		
			655	---	---	---	---	---	523	7625	91.1	1104	1443		
		765	---	---	---	---	---	---	610	7615	92.1	1104	1476		
			900	---	---	---	---	---	719	7629	93.0	1104	1510		
		1050	---	---	---	---	---	---	838	7621	93.7	1104	1544		
		58	455	---	---	---	---	---	---	366	7681	90.8	1008		
505	---			---	---	---	---	406	7677	91.5	1008	1240			
530	---			---	---	---	---	---	426	7676	91.9	1008	1250		
	605			---	---	---	---	---	485	7655	92.5	1008	1276		
705	---			---	---	---	---	---	565	7653	93.4	1008	1303		
	825			---	---	---	---	---	664	7686	94.1	1008	1331		
965	---			---	---	---	---	---	773	7653	94.7	1008	1351		
59	440			---	---	---	---	---	---	281	6099	90.1	780	41.4	0.459
		490	---	---	---	---	---	311	6061	90.6	780	1403			
		515	---	---	---	---	---	---	327	6063	91.1	780	1416		
			585	---	---	---	---	---	373	6089	92.0	780	1452		
		685	---	---	---	---	---	---	434	6050	92.7	780	1490		
			805	---	---	---	---	---	511	6062	93.6	780	1529		
		940	---	---	---	---	---	---	596	6050	94.3	780	1598		
		60	435	---	---	---	---	---	---	360	7903	89.6	1005		
485	---			---	---	---	---	399	7856	90.2	1005	1367			
510	---			---	---	---	---	---	419	7845	90.6	1005	1381		
	580			---	---	---	---	---	478	7870	91.5	1005	1415		
675	---			---	---	---	---	---	557	7880	92.4	1005	1450		
	794			---	---	---	---	---	655	7880	93.1	1005	1486		
925	---			---	---	---	---	---	763	7880	93.7	1005	1572		
61	405			---	---	---	---	---	---	329	7757	89.0	924	37.2	0.628
		450	---	---	---	---	---	365	7746	89.8	924	1317			
		475	---	---	---	---	---	---	383	7700	90.1	924	1330		
			540	---	---	---	---	---	437	7728	91.0	924	1364		
		630	---	---	---	---	---	---	510	7730	92.0	924	1400		
			741	---	---	---	---	---	600	7730	92.8	924	1437		
		864	---	---	---	---	---	---	699	7730	93.4	924	1469		

Nota (\*) - VENTILAZIONE SOLO L.O. / FAN ONLY SIDE COMMUTATOR

Nota (°) - Regolazione di campo / Field weakening



Potenza eccitazione Excitation power	(w)	4600	Tipo Size Ventilazione Ventilation	MGL C 500 K  IC 06
Cost. tempo eccitaz. Field time constant	(ms)	1080		
Massa del motore Mass of the motor	(Kg)	5645		
Momento d'inerzia rotore Rotor inertia moment	(Kgm2)	60		

Avv.	Velocità nominale n/min a tensione nominale di armatura Rated speed (rev/min) at rated voltage							Potenza Power kW	Coppia vel.nomin. Torque at rated speed Nm	Rendimento Efficiency %	Circuito di armatura Armature circuit			Max giri Max. speed (°)					
	400	440	460	520	600	700	810				Corrente Current Amp	Res. 115°C mOhm	Ind. mH						
62	385	---	---	---	---	---	---	317	7863	89.0	890	38.8	0.719	1250					
		425	---	---	---	---	---	351	7887	89.6				1279					
		445	---	---	---	---	---	369	7918	90.1				1292					
			510	---	---	---	---	421	7883	91.0				1326					
		595	---	---	---	---	491	7880	91.9	1362									
		700	---	---	---	---	578	7880	92.7	1399									
		816	---	---	---	---	673	7880	93.4	1428									
63	355	---	---	---	---	---	---	294	7908	87.3	842	48.3	0.656	1275					
		395	---	---	---	---	---	327	7905	88.3				1309					
		415	---	---	---	---	---	344	7916	88.8				1324					
			475	---	---	---	---	393	7901	89.8				1363					
		555	---	---	---	---	460	7915	91.1	1404									
		654	---	---	---	---	542	7915	92.0	1446									
		763	---	---	---	---	633	7915	92.8	1450									
64	340	---	---	---	---	---	---	279	7836	87.4	798	51.4	0.797	1138					
		375	---	---	---	---	---	310	7894	88.3				1167					
		395	---	---	---	---	---	326	7881	88.8				1179					
			450	---	---	---	---	373	7915	89.9				1212					
		530	---	---	---	---	435	7838	90.9	1246									
		625	---	---	---	---	513	7838	91.8	1281									
		729	---	---	---	---	598	7838	92.6	1312									
65	320	---	---	---	---	---	---	241	7192	86.6	696	62.5	0.9	1297					
		355	---	---	---	---	---	268	7209	87.5				1337					
		375	---	---	---	---	---	282	7181	88.1				1354					
			430	---	---	---	---	323	7173	89.2				1400					
		500	---	---	---	---	377	7200	90.3	1449									
		590	---	---	---	---	445	7200	91.3	1500									
		689	---	---	---	---	519	7200	92.1	1515									
66	305	---	---	---	---	---	---	264	8266	86.3	765	59.3	0.802	633					
		340	---	---	---	---	---	294	8257	87.3				641					
		360	---	---	---	---	---	309	8197	87.8				645					
			410	---	---	---	---	354	8245	89.0				654					
		480	---	---	---	---	414	8236	90.2	663									
		67	285	---	---	---	---	---	---	247				8276	85.8	720	65.7	0.97	608
				315	---	---	---	---	---	276				8367	87.1				615
335	---			---	---	---	---	290	8267	87.6	619								
	380			---	---	---	---	332	8343	88.7	628								
445	---			---	---	---	389	8348	90.0	637									
68	266			---	---	---	---	---	---	224	8042	85.2	657	74.8	1.27				590
				296	---	---	---	---	---	250	8065	86.5							598
		310	---	---	---	---	---	263	8102	87.0	601								
			355	---	---	---	---	302	8124	88.4	610								
		420	---	---	---	---	353	8026	89.5	631									
		496	---	---	---	---	417	8026	90.7	653									

Nota (\*) - VENTILAZIONE SOLO L.O. / FAN ONLY SIDE COMMUTATOR

Nota (°) - Regolazione di campo / Field weakening



Potenza eccitazione Excitation power	(w)	5000	Tipo Size	MGL C 500 S
Cost. tempo eccitaz. Field time constant	(ms)	1120	Ventilazione Ventilation	IC 06
Massa del motore Mass of the motor	(Kg)	5930		
Momento d'inerzia rotore Rotor inertia moment	(Kgm2)	66		

Avv.	Velocità nominale n/min a tensione nominale di armatura Rated speed (rev/min) at rated voltage							Potenza Power kW	Coppia vel.nomin. Torque at rated speed Nm	Rendimento Efficiency %	Circuito di armatura Armature circuit			Max giri Max. speed (°)	*
	400	440	460	520	600	700	810				Corrente Current Amp	Res. 115°C mOhm	Ind. mH		
41	1185	---	---	---	---	---	---	1011	8147	94.5	2676	4.71	0.078	1414	*
		1305	---	---	---	---	---	1116	8166	94.8	2676			1428	*
		---	1365	---	---	---	---	1166	8157	95.0	2668			1437	*
42	1045	---	---	---	---	---	---	1009	9220	94.5	2670	5.50	0.095	1335	*
		1155	---	---	---	---	---	1114	9210	94.8	2670			1347	*
		---	1210	---	---	---	---	1167	9210	95.0	2670			1353	*
		---	---	1375	---	---	---	1320	9167	95.4	2662			1405	*
43	915	---	---	---	---	---	---	895	9341	94.2	2376	5.72	0.115	1327	*
		1010	---	---	---	---	---	989	9351	94.6	2376			1340	*
		---	1060	---	---	---	---	1032	9297	94.7	2370			1349	*
		---	---	1200	---	---	---	1139	9064	95.2	2302			1404	*
		---	---	---	1395	---	---	1269	8687	95.6	2212			1477	*
44	865	---	---	---	---	---	---	844	9318	94.0	2244	6.43	0.132	1386	*
		955	---	---	---	---	---	932	9319	94.4	2244			1401	*
		---	1000	---	---	---	---	976	9320	94.6	2244			1407	*
		---	---	1135	---	---	---	1106	9305	94.9	2241			1426	*
		---	---	---	1315	---	---	1232	8947	95.4	2152			1504	*
45	820	---	---	---	---	---	---	800	9316	93.9	2130	6.83	0.165	1211	*
		905	---	---	---	---	---	884	9328	94.3	2130			1223	*
		---	950	---	---	---	---	926	9308	94.5	2130			1229	*
		---	---	1075	---	---	---	1049	9318	94.9	2126			1245	*
		---	---	---	1250	---	---	1169	8931	95.4	2042			1311	*
46	770	---	---	---	---	---	---	712	8830	92.7	1920	10.8	0.127	1402	*
		850	---	---	---	---	---	788	8853	93.3	1920			1420	*
		---	895	---	---	---	---	826	8813	93.5	1920			1427	*
		---	---	1015	---	---	---	939	8834	94.1	1920			1447	*
		---	---	---	1180	---	---	1090	8821	94.6	1920			1468	*
		---	---	---	---	1385	---	1279	8819	95.2	1920			1610	*
47	715	---	---	---	---	---	---	736	9830	93.1	1976	10.2	0.142	1366	*
		790	---	---	---	---	---	814	9839	93.6	1976			1383	*
		---	830	---	---	---	---	853	9814	93.8	1976			1390	*
		---	---	940	---	---	---	970	9854	94.4	1976			1409	*
		---	---	---	1095	---	---	1126	9820	95.0	1976			1429	*
		---	---	---	---	1280	---	1321	9855	95.5	1976			1567	*

Nota (\*) - VENTILAZIONE SOLO L.O. / FAN ONLY SIDE COMMUTATOR

Nota (°) - Regolazione di campo / Field weakening



Potenza eccitazione Excitation power (w) 5000	Tipo Size MGL C 500 S
Cost. tempo eccitaz. Field time constant (ms) 1120	Ventilazione Ventilation IC 06
Massa del motore Mass of the motor (Kg) 5930	
Momento d'inerzia rotore Rotor inertia moment (Kgm2) 66	

Avv.	Velocità nominale n/min a tensione nominale di armatura Rated speed (rev/min) at rated voltage							Potenza Power kW	Coppia vel.nomin. Torque at rated speed Nm	Rendimento Efficiency %	Circuito di armatura Armature circuit			Max giri Max. speed (°)	
	400	440	460	520	600	700	810				Corrente Current Amp	Res. 115°C mOhm	Ind. mH		
48	705	---	---	---	---	---	---	687	9306	92.9	1848	10.0	0.177	1316	*
		780	---	---	---	---	---	760	9304	93.5	1848			1332	
		820	---	---	---	---	---	796	9270	93.6	1848			1340	
		930	---	---	---	---	---	905	9293	94.2	1848			1358	
		1080	---	---	---	---	---	1050	9284	94.7	1848			1378	
		1270	---	---	---	---	---	1235	9284	95.4	1848			1404	
		---	---	---	---	---	---	---	---	---	---			---	
49	675	---	---	---	---	---	---	661	9351	92.9	1779	10.5	0.209	1282	*
		750	---	---	---	---	---	731	9307	93.4	1779			1299	
		785	---	---	---	---	---	766	9318	93.6	1779			1306	
		890	---	---	---	---	---	871	9345	94.2	1779			1325	
		1035	---	---	---	---	---	1011	9328	94.7	1779			1345	
		1213	---	---	---	---	---	1185	9328	95.2	1779			1371	
		---	---	---	---	---	---	---	---	---	---			---	
50	635	---	---	---	---	---	---	621	9339	92.2	1683	12.7	0.193	1228	*
		705	---	---	---	---	---	687	9306	92.8	1683			1245	
		740	---	---	---	---	---	720	9291	93.0	1683			1252	
		840	---	---	---	---	---	820	9322	93.7	1683			1270	
		975	---	---	---	---	---	952	9324	94.3	1683			1290	
		1144	---	---	---	---	---	1117	9324	94.8	1683			1310	
		1329	---	---	---	---	---	1298	9324	95.2	1683			1382	
51	600	---	---	---	---	---	---	588	9358	92.1	1596	13.9	0.223	1168	*
		665	---	---	---	---	---	651	9348	92.7	1596			1184	
		700	---	---	---	---	---	682	9304	92.9	1596			1190	
		795	---	---	---	---	---	776	9321	93.5	1596			1208	
		925	---	---	---	---	---	902	9312	94.2	1596			1227	
		1085	---	---	---	---	---	1058	9312	94.7	1596			1246	
		1261	---	---	---	---	---	1230	9312	95.1	1596			1312	
52	575	---	---	---	---	---	---	512	8503	92.0	1392	17.4	0.264	1247	*
		640	---	---	---	---	---	566	8445	92.4	1392			1266	
		670	---	---	---	---	---	594	8466	92.8	1392			1275	
		760	---	---	---	---	---	676	8494	93.4	1392			1297	
		885	---	---	---	---	---	786	8481	94.1	1392			1319	
		1040	---	---	---	---	---	923	8475	94.7	1392			1341	
		1210	---	---	---	---	---	1073	8468	95.2	1392			1392	
53	530	---	---	---	---	---	---	515	9279	90.7	1420	21.2	0.314	1360	*
		590	---	---	---	---	---	572	9258	91.5	1420			1384	
		620	---	---	---	---	---	600	9241	91.9	1420			1395	
		705	---	---	---	---	---	684	9265	92.6	1420			1422	
		820	---	---	---	---	---	796	9270	93.4	1420			1451	
		965	---	---	---	---	---	936	9262	94.2	1420			1481	
		1125	---	---	---	---	---	1091	9261	94.9	1420			1496	
54	500	---	---	---	---	---	---	489	9339	91.4	1338	19.0	0.326	1281	*
		555	---	---	---	---	---	541	9308	91.9	1338			1304	
		580	---	---	---	---	---	568	9352	92.3	1338			1314	
		660	---	---	---	---	---	646	9347	92.8	1338			1341	
		770	---	---	---	---	---	752	9326	93.7	1338			1368	
		904	---	---	---	---	---	883	9326	94.3	1338			1396	
		1051	---	---	---	---	---	1027	9326	94.7	1338			1419	

Nota (\*) - VENTILAZIONE SOLO L.O. / FAN ONLY SIDE COMMUTATOR

Nota (°) - Regolazione di campo / Field weakening



Potenza eccitazione Excitation power (w) 5000	Tipo Size MGL C 500 S
Cost. tempo eccitaz. Field time constant (ms) 1120	Ventilazione Ventilation IC 06
Massa del motore Mass of the motor (Kg) 5930	
Momento d'inerzia rotore Rotor inertia moment (Kgm2) 66	

Avv.	Velocità nominale n/min a tensione nominale di armatura Rated speed (rev/min) at rated voltage							Potenza Power kW	Coppia vel.nomin. Torque at rated speed Nm	Rendimento Efficiency %	Circuito di armatura Armature circuit			Max giri Max. speed (°)	
	400	440	460	520	600	700	810				Corrente Current Amp	Res. 115°C mOhm	Ind. mH		
55	450	---	---	---	---	---	---	453	9613	89.9	1260	26.3	0.402	1207	
		500	---	---	---	---	---	503	9607	90.7	1260			1229	
		520	---	---	---	---	---	---	528	9696	91.1			1260	1239
			595	---	---	---	---	---	603	9678	92.0			1260	1264
		695	---	---	---	---	---	---	702	9646	92.9			1260	1291
			815	---	---	---	---	---	827	9690	93.8			1260	1319
		950	---	---	---	---	---	---	964	9690	94.5			1260	1283
		56	440	---	---	---	---	---	---	432	9376			90.9	1188
490	---			---	---	---	---	478	9315	91.4	1188	1217			
515	---			---	---	---	---	---	502	9308	91.9	1188	1227		
	585			---	---	---	---	---	572	9337	92.6	1188	1253		
680	---			---	---	---	---	---	665	9339	93.3	1188	1281		
	799			---	---	---	---	---	781	9339	93.9	1188	1310		
929	---			---	---	---	---	---	909	9339	94.5	1188	1320		
57	410			---	---	---	---	---	---	390	9084	88.3	1104	35.2	0.552
		460	---	---	---	---	---	434	9010	89.3	1104	1259			
		480	---	---	---	---	---	---	455	9052	89.6	1104	1270		
			550	---	---	---	---	---	521	9046	90.8	1104	1301		
		640	---	---	---	---	---	---	607	9057	91.6	1104	1332		
			754	---	---	---	---	---	715	9057	92.5	1104	1364		
		885	---	---	---	---	---	---	836	9021	93.5	1104	1407		
		58	385	---	---	---	---	---	---	364	9028	90.3	1008		
425	---			---	---	---	---	404	9078	91.1	1008	1107			
445	---			---	---	---	---	---	424	9099	91.4	1008	1116		
	510			---	---	---	---	---	483	9044	92.1	1008	1141		
695	---			---	---	---	---	---	563	7736	93.1	1008	1167		
	700			---	---	---	---	---	662	9031	93.8	1008	1194		
815	---			---	---	---	---	---	771	9033	94.4	1008	1182		
59	370			---	---	---	---	---	---	279	7201	89.4	780	44.4	0.531
		410	---	---	---	---	---	310	7220	90.3	780	1257			
		430	---	---	---	---	---	---	325	7218	90.6	780	1270		
			490	---	---	---	---	---	371	7230	91.5	780	1304		
		570	---	---	---	---	---	---	433	7254	92.5	780	1341		
			670	---	---	---	---	---	509	7254	93.2	780	1379		
		785	---	---	---	---	---	---	594	7226	94.0	780	1389		
		60	365	---	---	---	---	---	---	358	9366	89.1	1005		
405	---			---	---	---	---	397	9361	89.8	1005	1227			
425	---			---	---	---	---	---	417	9370	90.2	1005	1240		
	485			---	---	---	---	---	476	9372	91.1	1005	1273		
570	---			---	---	---	---	---	556	9315	92.2	1005	1308		
	671			---	---	---	---	---	654	9315	93.0	1005	1344		
782	---			---	---	---	---	---	763	9315	93.7	1005	1368		
61	340			---	---	---	---	---	---	327	9184	88.5	924	40.4	0.729
		380	---	---	---	---	---	363	9122	89.3	924	1178			
		400	---	---	---	---	---	---	381	9096	89.6	924	1191		
			455	---	---	---	---	---	436	9151	90.7	924	1223		
		530	---	---	---	---	---	---	508	9153	91.6	924	1258		
			624	---	---	---	---	---	598	9153	92.5	924	1294		
		728	---	---	---	---	---	---	698	9153	93.2	924	1303		

Nota (\*) - VENTILAZIONE SOLO L.O. / FAN ONLY SIDE COMMUTATOR

Nota (°) - Regolazione di campo / Field weakening



Potenza eccitazione Excitation power	(w)	5000	Tipo Size	MGL C 500 S
Cost. tempo eccitaz. Field time constant	(ms)	1120	Ventilazione Ventilation	IC 06
Massa del motore Mass of the motor	(Kg)	5930		
Momento d'inerzia rotore Rotor inertia moment	(Kgm2)	66		

Avv.	Velocità nominale n/min a tensione nominale di armatura Rated speed (rev/min) at rated voltage							Potenza Power kW	Coppia vel.nomin. Torque at rated speed Nm	Rendimento Efficiency %	Circuito di armatura Armature circuit			Max giri Max. speed (°)				
	400	440	460	520	600	700	810				Corrente Current Amp	Res. 115°C mOhm	Ind. mH					
62	320	---	---	---	---	---	---	315	9400	88.5	890	42.2	0.836	1115				
		360	---	---	---	---	---	350	9284	89.4	890			1143				
		---	375	---	---	---	---	367	9346	89.6	890			1156				
		---	---	430	---	---	---	420	9327	90.8	890			1189				
		---	---	---	500	---	---	490	9358	91.8	890			1223				
		---	---	---	---	589	---	577	9358	92.6	890			1258				
		---	---	---	---	---	687	673	9358	93.3	890			1270				
		---	---	---	---	---	---	---	---	---	---			---	---	---	---	---
63	299	---	---	---	---	---	---	292	9326	86.7	842	52.4	0.758	1138				
		335	---	---	---	---	---	325	9264	87.7	842			1171				
		---	350	---	---	---	---	342	9331	88.3	842			1185				
		---	---	400	---	---	---	392	9358	89.5	842			1223				
		---	---	---	470	---	---	458	9306	90.7	842			1263				
		---	---	---	---	555	---	540	9306	91.7	842			1304				
		---	---	---	---	---	648	631	9306	92.5	842			1360				
		---	---	---	---	---	---	---	---	---	---			---	---	---	---	---
64	283	---	---	---	---	---	---	277	9347	86.8	798	55.7	0.924	1010				
		315	---	---	---	---	---	308	9337	87.7	798			1037				
		---	330	---	---	---	---	324	9376	88.3	798			1049				
		---	---	380	---	---	---	371	9323	89.4	798			1080				
		---	---	---	445	---	---	434	9313	90.6	798			1113				
		---	---	---	---	525	---	512	9313	91.7	798			1147				
		---	---	---	---	---	613	598	9313	92.5	798			1159				
		---	---	---	---	---	---	---	---	---	---			---	---	---	---	---
65	267	---	---	---	---	---	---	239	8548	85.8	696	67.8	1.04	1153				
		298	---	---	---	---	---	267	8556	87.2	696			1191				
		---	315	---	---	---	---	280	8488	87.5	696			1207				
		---	---	360	---	---	---	321	8515	88.7	696			1251				
		---	---	---	420	---	---	376	8549	90.0	696			1298				
		---	---	---	---	496	---	444	8549	91.1	696			1347				
		---	---	---	---	---	580	519	8549	92.0	696			1356				
		---	---	---	---	---	---	---	---	---	---			---	---	---	---	---
66	257	---	---	---	---	---	---	262	9735	85.6	765	64.2	0.928	575				
		286	---	---	---	---	---	292	9750	86.7	765			583				
		---	300	---	---	---	---	307	9772	87.2	765			587				
		---	---	345	---	---	---	352	9743	88.5	765			596				
		---	---	---	405	---	---	412	9714	89.8	765			605				
		---	---	---	---	---	---	---	---	---	---			---	---	---	---	---
		---	---	---	---	---	---	---	---	---	---			---	---	---	---	---
		---	---	---	---	---	---	---	---	---	---			---	---	---	---	---
67	238	---	---	---	---	---	---	245	9830	85.1	720	71.3	1.12	551				
		266	---	---	---	---	---	273	9801	86.2	720			558				
		---	279	---	---	---	---	287	9823	86.7	720			562				
		---	---	320	---	---	---	330	9848	88.1	720			571				
		---	---	---	375	---	---	387	9855	89.6	720			579				
		---	---	---	---	---	---	---	---	---	---			---	---	---	---	---
68	222	---	---	---	---	---	---	222	9549	84.5	657	81.2	1.47	532				
		248	---	---	---	---	---	248	9549	85.8	657			540				
		---	261	---	---	---	---	261	9549	86.4	657			543				
		---	---	300	---	---	---	300	9549	87.8	657			552				
		---	---	---	350	---	---	351	9577	89.0	657			561				
		---	---	---	---	414	---	415	9577	90.3	657			570				
		---	---	---	---	---	---	---	---	---	---			---	---	---	---	---
		---	---	---	---	---	---	---	---	---	---			---	---	---	---	---

Nota (\*) - VENTILAZIONE SOLO L.O. / FAN ONLY SIDE COMMUTATOR

Nota (°) - Regolazione di campo / Field weakening





Potenza eccitazione Excitation power	(w)	5600	Tipo Size Ventilazione Ventilation	MGL C 500 M IC 06
Cost. tempo eccitaz. Field time constant	(ms)	1160		
Massa del motore Mass of the motor	(Kg)	6300		
Momento d'inerzia rotore Rotor inertia moment	(Kgm2)	73.7		

Avv.	Velocità nominale n/min a tensione nominale di armatura Rated speed (rev/min) at rated voltage							Potenza Power kW	Coppia vel.nomin. Torque at rated speed Nm	Rendimento Efficiency %	Circuito di armatura Armature circuit			Max giri Max. speed (°)	*
	400	440	460	520	600	700	810				Corrente Current Amp	Res. 115°C mOhm	Ind. mH		
41	980	---	---	---	---	---	---	1010	9842	94.4	2676	5.20	0.092	1258	*
		1075	---	---	---	---	---	1115	9905	94.7	2676			1270	*
		---	1125	---	---	---	---	1168	9914	94.9	2676			1276	*
42	865	---	---	---	---	---	---	1005	11095	94.1	2670	6.00	0.113	1182	*
		955	---	---	---	---	---	1110	11099	94.5	2670			1194	*
		---	1000	---	---	---	---	1163	11106	94.7	2670			1199	*
		---	---	1140	---	---	---	1321	11066	95.1	2670			1212	*
43	755	---	---	---	---	---	---	894	11307	94.1	2376	6.34	0.137	1174	*
		835	---	---	---	---	---	987	11288	94.4	2376			1187	*
		---	875	---	---	---	---	1034	11285	94.6	2376			1192	*
		---	---	995	---	---	---	1174	11267	95.0	2376			1206	*
		---	---	---	1155	---	---	1333	11021	95.6	2325			1248	*
44	715	---	---	---	---	---	---	842	11246	93.8	2244	7.11	0.157	1230	*
		790	---	---	---	---	---	930	11242	94.2	2244			1245	*
		---	825	---	---	---	---	975	11286	94.5	2244			1251	*
		---	---	940	---	---	---	1107	11246	94.9	2244			1267	*
		---	---	---	1090	---	---	1284	11249	95.4	2244			1284	*
45	675	---	---	---	---	---	---	799	11304	93.8	2130	7.55	0.196	1066	*
		750	---	---	---	---	---	883	11243	94.2	2130			1077	*
		---	785	---	---	---	---	925	11252	94.4	2130			1082	*
		---	---	890	---	---	---	1050	11266	94.8	2130			1095	*
		---	---	---	1035	---	---	1218	11238	95.3	2130			1109	*
46	635	---	---	---	---	---	---	708	10647	92.2	1920	11.9	0.15	1241	*
		705	---	---	---	---	---	784	10619	92.8	1920			1258	*
		---	735	---	---	---	---	822	10680	93.1	1920			1265	*
		---	---	840	---	---	---	935	10629	93.6	1920			1284	*
		---	---	---	975	---	---	1086	10637	94.3	1920			1303	*
		---	---	---	---	1145	---	1275	10634	94.9	1920			1339	*
47	590	---	---	---	---	---	---	732	11848	92.6	1976	11.2	0.168	1211	*
		650	---	---	---	---	---	810	11900	93.2	1976			1227	*
		---	685	---	---	---	---	849	11836	93.4	1976			1234	*
		---	---	780	---	---	---	966	11826	94.0	1976			1252	*
		---	---	---	905	---	---	1122	11839	94.6	1976			1271	*
		---	---	---	---	1060	---	1317	11865	95.2	1976			1454	*

Nota (\*) - VENTILAZIONE SOLO L.O. / FAN ONLY SIDE COMMUTATOR

Nota (°) - Regolazione di campo / Field weakening



Potenza eccitazione Excitation power (w) 5600	Tipo Size MGL C 500 M
Cost. tempo eccitaz. Field time constant (ms) 1160	Ventilazione Ventilation IC 06
Massa del motore Mass of the motor (Kg) 6300	
Momento d'inerzia rotore Rotor inertia moment (Kgm2) 73.7	

Avv.	Velocità nominale n/min a tensione nominale di armatura Rated speed (rev/min) at rated voltage							Potenza Power kW	Coppia vel.nomin. Torque at rated speed Nm	Rendimento Efficiency %	Circuito di armatura Armature circuit			Max giri Max. speed (°)	
	400	440	460	520	600	700	810				Corrente Current Amp	Res. 115°C mOhm	Ind. mH		
48	580	---	---	---	---	---	---	685	11278	92.7	1848	11.1	0.210	1162	*
		640	---	---	---	---	---	758	11310	93.2	1848			1178	
		---	670	---	---	---	---	794	11317	93.4	1848			1185	
		---	---	770	---	---	---	903	11199	94.0	1848			1203	
		---	---	---	890	---	---	1049	11255	94.6	1848			1221	
		---	---	---	---	1050	---	1238	11255	95.7	1848			1365	
		---	---	---	---	---	---	---	---	---	---			---	
49	560	---	---	---	---	---	---	659	11238	92.6	1779	11.7	0.248	1132	*
		620	---	---	---	---	---	729	11228	93.1	1779			1148	
		---	650	---	---	---	---	764	11224	93.4	1779			1155	
		---	---	735	---	---	---	869	11290	93.9	1779			1173	
		---	---	---	855	---	---	1009	11269	94.5	1779			1192	
		---	---	---	---	1003	---	1183	11269	95.0	1779			1303	
		---	---	---	---	---	---	---	---	---	---			---	
50	525	---	---	---	---	---	---	619	11259	91.9	1683	14.1	0.227	1081	
		580	---	---	---	---	---	685	11278	92.5	1683			1097	
		---	610	---	---	---	---	718	11240	92.7	1683			1104	
		---	---	695	---	---	---	818	11239	93.5	1683			1121	
		---	---	---	805	---	---	950	11269	94.1	1683			1140	
		---	---	---	---	945	---	1115	11269	94.6	1683			1159	
		---	---	---	---	---	1098	1296	11269	95.1	1683			1263	
51	495	---	---	---	---	---	---	586	11305	91.8	1596	15.3	0.264	1025	
		550	---	---	---	---	---	649	11268	92.4	1596			1040	
		---	575	---	---	---	---	680	11293	92.6	1596			1046	
		---	---	655	---	---	---	774	11284	93.3	1596			1063	
		---	---	---	765	---	---	900	11235	94.0	1596			1080	
		---	---	---	---	898	---	1056	11235	94.6	1596			1097	
		---	---	---	---	---	1044	1228	11235	95.0	1596			1138	
52	475	---	---	---	---	---	---	509	10233	91.4	1392	19.0	0.312	1093	
		525	---	---	---	---	---	563	10241	91.9	1392			1111	
		---	555	---	---	---	---	591	10169	92.3	1392			1119	
		---	---	630	---	---	---	673	10201	93.0	1392			1139	
		---	---	---	735	---	---	783	10173	93.8	1392			1161	
		---	---	---	---	860	---	920	10216	94.4	1392			1183	
		---	---	---	---	---	1000	1070	10213	94.9	1392			1251	
53	440	---	---	---	---	---	---	512	11112	90.1	1420	23.0	0.372	1205	
		485	---	---	---	---	---	568	11184	90.9	1420			1228	
		---	510	---	---	---	---	596	11160	91.2	1420			1238	
		---	---	580	---	---	---	680	11196	92.1	1420			1264	
		---	---	---	680	---	---	792	11122	93.0	1420			1292	
		---	---	---	---	800	---	933	11139	93.9	1420			1321	
		---	---	---	---	---	930	1087	11161	94.5	1420			1376	
54	415	---	---	---	---	---	---	486	11183	90.8	1338	21.1	0.386	1130	
		455	---	---	---	---	---	539	11312	91.6	1338			1152	
		---	480	---	---	---	---	565	11240	91.8	1338			1162	
		---	---	545	---	---	---	644	11284	92.6	1338			1187	
		---	---	---	635	---	---	750	11279	93.4	1338			1213	
		---	---	---	---	746	---	881	11279	94.1	1338			1240	
		---	---	---	---	---	868	1025	11279	94.6	1338			1285	

Nota (\*) - VENTILAZIONE SOLO L.O. / FAN ONLY SIDE COMMUTATOR

Nota (°) - Regolazione di campo / Field weakening



Potenza eccitazione Excitation power (w) 5600	Tipo Size MGL C 500 M
Cost. tempo eccitaz. Field time constant (ms) 1160	Ventilazione Ventilation IC 06
Massa del motore Mass of the motor (Kg) 6300	
Momento d'inerzia rotore Rotor inertia moment (Kgm2) 73.7	

Avv.	Velocità nominale n/min a tensione nominale di armatura Rated speed (rev/min) at rated voltage							Potenza Power kW	Coppia vel.nomin. Torque at rated speed Nm	Rendimento Efficiency %	Circuito di armatura Armature circuit			Max giri Max. speed (°)	
	400	440	460	520	600	700	810				Corrente Current Amp	Res. 115°C mOhm	Ind. mH		
55	370	---	---	---	---	---	---	450	11614	89.3	1260	28.7	0.476	1061	
		410	---	---	---	---	---	499	11622	90.0	1260			1082	
		430	---	---	---	---	---	---	524	11637	90.4			1260	1091
			490	---	---	---	---	---	599	11674	91.4			1260	1115
		570	---	---	---	---	---	---	699	11711	92.5			1260	1140
			675	---	---	---	---	---	823	11643	93.3			1260	1166
			785	---	---	---	---	---	960	11678	94.1			1260	1162
56	365	---	---	---	---	---	---	429	11224	90.3	1188	25.6	0.547	1048	
		405	---	---	---	---	---	476	11223	91.1	1188			1070	
		425	---	---	---	---	---	---	499	11212	91.3			1188	1080
			480	---	---	---	---	---	570	11340	92.3			1188	1105
		560	---	---	---	---	---	---	663	11306	93.0			1188	1131
			658	---	---	---	---	---	779	11306	93.7			1188	1158
			766	---	---	---	---	---	907	11306	94.3			1188	1188
57	340	---	---	---	---	---	---	386	10841	87.4	1104	38.4	0.654	1084	
		375	---	---	---	---	---	430	10950	88.5	1104			1109	
		395	---	---	---	---	---	---	451	10903	88.8			1104	1120
			450	---	---	---	---	---	517	10971	90.1			1104	1149
		530	---	---	---	---	---	---	604	10883	91.2			1104	1179
			625	---	---	---	---	---	712	10883	92.2			1104	1210
			730	---	---	---	---	---	831	10883	93.0			1104	1277
58	315	---	---	---	---	---	---	361	10944	89.5	1008	33.5	0.571	947	
		350	---	---	---	---	---	401	10941	90.4	1008			968	
		370	---	---	---	---	---	---	421	10866	90.8			1008	977
			420	---	---	---	---	---	481	10936	91.8			1008	1000
		490	---	---	---	---	---	---	560	10914	92.6			1008	1024
			575	---	---	---	---	---	659	10944	93.4			1008	1049
			670	---	---	---	---	---	769	10961	94.2			1008	1105
59	300	---	---	---	---	---	---	276	8785	88.5	780	48.6	0.626	1075	
		335	---	---	---	---	---	307	8751	89.5	780			1103	
		350	---	---	---	---	---	---	323	8813	90.0			780	1115
			400	---	---	---	---	---	369	8809	91.0			780	1148
		470	---	---	---	---	---	---	430	8737	91.9			780	1182
			555	---	---	---	---	---	507	8724	92.9			780	1217
			645	---	---	---	---	---	591	8750	93.5			780	1238
60	300	---	---	---	---	---	---	355	11300	88.3	1005	38.3	0.671	1052	
		335	---	---	---	---	---	395	11260	89.3	1005			1079	
		350	---	---	---	---	---	---	414	11296	89.6			1005	1091
			400	---	---	---	---	---	474	11316	90.7			1005	1123
		470	---	---	---	---	---	---	553	11236	91.7			1005	1156
			554	---	---	---	---	---	651	11236	92.6			1005	1190
			646	---	---	---	---	---	760	11236	93.3			1005	1227
61	280	---	---	---	---	---	---	324	11050	87.7	924	44.6	0.864	1005	
		310	---	---	---	---	---	360	11090	88.5	924			1032	
		330	---	---	---	---	---	---	379	10967	89.2			924	1044
			375	---	---	---	---	---	433	11026	90.1			924	1074
		440	---	---	---	---	---	---	506	10982	91.3			924	1107
			519	---	---	---	---	---	597	10982	92.2			924	1141
			605	---	---	---	---	---	696	10982	93.0			924	1199

Nota (\*) - VENTILAZIONE SOLO L.O. / FAN ONLY SIDE COMMUTATOR

Nota (°) - Regolazione di campo / Field weakening



Potenza eccitazione Excitation power	(w)	5600	Tipo Size Ventilazione Ventilation	MGL C 500 M  IC 06
Cost. tempo eccitaz. Field time constant	(ms)	1160		
Massa del motore Mass of the motor	(Kg)	6300		
Momento d'inerzia rotore Rotor inertia moment	(Kgm2)	73.7		

Avv.	Velocità nominale n/min a tensione nominale di armatura Rated speed (rev/min) at rated voltage							Potenza Power kW	Coppia vel.nomin. Torque at rated speed Nm	Rendimento Efficiency %	Circuito di armatura Armature circuit			Max giri Max. speed (°)			
	400	440	460	520	600	700	810				Corrente Current Amp	Res. 115°C mOhm	Ind. mH				
62	264	---	---	---	---	---	---	312	11286	87.6	890	46.6	0.991	974			
		294	---	---	---	---	---	347	11271	88.6	890			1001			
		310	---	---	---	---	---	---	364	11213	88.9			890	1013		
			355	---	---	---	---	---	417	11217	90.1			890	1043		
		415	---	---	---	---	---	---	487	11206	91.2			890	1076		
			489	---	---	---	---	---	574	11206	92.2			890	1110		
		571		---	---	---	---	---	670	11206	93.0			890	1199		
63	245	---	---	---	---	---	---	289	11264	85.8	842	57.9	0.895	995			
		273	---	---	---	---	---	322	11263	86.9	842			1025			
		287	---	---	---	---	---	---	339	11280	87.5			842	1039		
			330	---	---	---	---	---	389	11257	88.8			842	1075		
		385	---	---	---	---	---	---	455	11286	90.1			842	1113		
			455	---	---	---	---	---	538	11286	91.2			842	1152		
		532		---	---	---	---	---	628	11286	92.1			842	1223		
64	232	---	---	---	---	---	---	274	11278	85.8	798	61.6	1.09	877			
		259	---	---	---	---	---	305	11245	86.9	798			902			
		272	---	---	---	---	---	---	321	11270	87.4			798	914		
			310	---	---	---	---	---	368	11336	88.7			798	943		
		365	---	---	---	---	---	---	431	11276	90.0			798	973		
			431	---	---	---	---	---	509	11276	91.2			798	1004		
		504		---	---	---	---	---	595	11276	92.1			798	1109		
65	219	---	---	---	---	---	---	236	10291	84.8	696	74.9	1.23	1003			
		244	---	---	---	---	---	264	10332	86.2	696			1038			
		257	---	---	---	---	---	---	277	10292	86.5			696	1054		
			295	---	---	---	---	---	319	10326	88.1			696	1095		
		345	---	---	---	---	---	---	373	10324	89.3			696	1139		
			408	---	---	---	---	---	441	10324	90.5			696	1185		
		477		---	---	---	---	---	516	10324	91.5			696	1217		
66	210	---	---	---	---	---	---	259	11778	84.6	765	70.9	1.1	513			
		234	---	---	---	---	---	289	11794	85.9	765			520			
		246	---	---	---	---	---	---	304	11801	86.4			765	524		
			283	---	---	---	---	---	349	11776	87.7			765	532		
		330	---	---	---	---	---	---	409	11835	89.1			765	541		
			---	---	---	---	---	---	---	---	---			---	---	---	---
		67	194	---	---	---	---	---	---	242	11912			84.0	720	78.8	1.33
217	---			---	---	---	---	270	11882	85.2	720	497					
229	---			---	---	---	---	---	284	11843	85.7	720	500				
	263			---	---	---	---	---	327	11873	87.3	720	509				
310	---			---	---	---	---	---	383	11798	88.7	720	517				
	---			---	---	---	---	---	---	---	---	---	---	---	---		
68	181			---	---	---	---	---	---	219	11554	83.3	657	89.8	1.74		
		203	---	---	---	---	---	245	11525	84.8	657	478					
		213	---	---	---	---	---	---	258	11567	85.4	657	481				
			246	---	---	---	---	---	297	11529	86.9	657	490				
		288	---	---	---	---	---	---	348	11539	88.3	657	499				
			341	---	---	---	---	---	412	11539	89.7	657	508				
		---		---	---	---	---	---	---	---	---	---	---			---	---

Nota (\*) - VENTILAZIONE SOLO L.O. / FAN ONLY SIDE COMMUTATOR

Nota (°) - Regolazione di campo / Field weakening



Potenza eccitazione Excitation power	(w)	6200	Tipo Size Ventilazione Ventilation	MGL C 500 L IC 06
Cost. tempo eccitaz. Field time constant	(ms)	1240		
Massa del motore Mass of the motor	(Kg)	6720		
Momento d'inerzia rotore Rotor inertia moment	(Kgm2)	82.6		

Avv.	Velocità nominale n/min a tensione nominale di armatura Rated speed (rev/min) at rated voltage							Potenza Power kW	Coppia vel.nomin. Torque at rated speed Nm	Rendimento Efficiency %	Circuito di armatura Armature circuit			Max giri Max. speed (°)	*
	400	440	460	520	600	700	810				Corrente Current Amp	Res. 115°C mOhm	Ind. mH		
41	820	---	---	---	---	---	---	1008	11739	94.2	2676	5.76	0.108	1118	*
		900	---	---	---	---	---	1113	11809	94.5	2676			1130	*
		940	---	---	---	---	---	1166	11845	94.7	2676			1135	*
42	725	---	---	---	---	---	---	1001	13185	93.7	2670	6.60	0.133	1047	*
		800	---	---	---	---	---	1106	13202	94.1	2670			1058	*
		840	---	---	---	---	---	1159	13176	94.4	2670			1063	*
		955	---	---	---	---	---	1317	13169	94.9	2670			1076	*
43	630	---	---	---	---	---	---	892	13521	93.9	2376	7.02	0.161	1040	*
		700	---	---	---	---	---	985	13437	94.2	2376			1052	*
		730	---	---	---	---	---	1032	13500	94.4	2376			1057	*
		830	---	---	---	---	---	1173	13496	94.9	2376			1070	*
		965	---	---	---	---	---	1360	13458	95.4	2376			1084	*
44	595	---	---	---	---	---	---	840	13481	93.6	2244	7.88	0.185	1092	*
		660	---	---	---	---	---	928	13427	94.0	2244			1106	*
		690	---	---	---	---	---	972	13452	94.2	2244			1112	*
		785	---	---	---	---	---	1105	13442	94.7	2244			1127	*
		910	---	---	---	---	---	1282	13453	95.2	2244			1143	*
45	565	---	---	---	---	---	---	797	13470	93.5	2130	8.37	0.23	939	*
		625	---	---	---	---	---	881	13461	94.0	2130			950	*
		655	---	---	---	---	---	923	13457	94.2	2130			954	*
		745	---	---	---	---	---	1049	13446	94.7	2130			966	*
		865	---	---	---	---	---	1217	13435	95.2	2130			979	*
46	530	---	---	---	---	---	---	704	12684	91.7	1920	13.1	0.176	1098	*
		585	---	---	---	---	---	780	12732	92.3	1920			1114	*
		615	---	---	---	---	---	817	12686	92.5	1920			1121	*
		700	---	---	---	---	---	931	12701	93.2	1920			1139	*
		815	---	---	---	---	---	1082	12678	93.9	1920			1158	*
		960	---	---	---	---	---	1271	12643	94.6	1920			1339	*
47	490	---	---	---	---	---	---	728	14188	92.1	1976	12.3	0.197	1074	*
		545	---	---	---	---	---	806	14123	92.7	1976			1089	*
		570	---	---	---	---	---	845	14156	93.0	1976			1096	*
		650	---	---	---	---	---	962	14133	93.6	1976			1113	*
		755	---	---	---	---	---	1118	14141	94.3	1976			1131	*
		885	---	---	---	---	---	1313	14168	94.9	1976			1326	*

Nota (\*) - VENTILAZIONE SOLO L.O. / FAN ONLY SIDE COMMUTATOR

Nota (°) - Regolazione di campo / Field weakening



Potenza eccitazione Excitation power (w)	6200	Tipo Size	MGL C 500 L
Cost. tempo eccitaz. Field time constant (ms)	1240	Ventilazione Ventilation	IC 06
Massa del motore Mass of the motor (Kg)	6720		
Momento d'inerzia rotore Rotor inertia moment (Kgm2)	82.6		

Avv.	Velocità nominale n/min a tensione nominale di armatura Rated speed (rev/min) at rated voltage							Potenza Power kW	Coppia vel.nomin. Torque at rated speed Nm	Rendimento Efficiency %	Circuito di armatura Armature circuit			Max giri Max. speed (°)	
	400	440	460	520	600	700	810				Corrente Current Amp	Res. 115°C mOhm	Ind. mH		
48	480	---	---	---	---	---	---	682	13568	92.3	1848	12.3	0.247	1027	
		535	---	---	---	---	---	755	13476	92.9					1042
		560	---	---	---	---	---	792	13505	93.2					1048
		640	---	---	---	---	---	901	13444	93.8					1065
		740	---	---	---	---	---	1047	13511	94.4					1083
		870	---	---	---	---	---	1231	13511	95.2					1131
49	465	---	---	---	---	---	---	656	13472	92.2	1779	12.9	0.291	1000	
		515	---	---	---	---	---	727	13480	92.9					1015
		540	---	---	---	---	---	762	13475	93.1					1021
		615	---	---	---	---	---	867	13462	93.7					1038
		715	---	---	---	---	---	1007	13449	94.3					1056
		839	---	---	---	---	---	1182	13449	94.9					1091
50	435	---	---	---	---	---	---	616	13523	91.5	1683	15.6	0.267	953	
		485	---	---	---	---	---	682	13428	92.1					967
		510	---	---	---	---	---	715	13388	92.4					974
		580	---	---	---	---	---	815	13418	93.1					990
		675	---	---	---	---	---	948	13412	93.9					1007
		793	---	---	---	---	---	1113	13412	94.5					1024
51	415	---	---	---	---	---	---	583	13415	91.3	1596	16.9	0.309	901	
		460	---	---	---	---	---	646	13411	92.0					914
		480	---	---	---	---	---	677	13469	92.2					920
		550	---	---	---	---	---	772	13404	93.0					936
		640	---	---	---	---	---	897	13384	93.7					952
		752	---	---	---	---	---	1054	13384	94.3					968
52	395	---	---	---	---	---	---	505	12209	90.7	1392	20.8	0.366	959	
		440	---	---	---	---	---	560	12154	91.4					976
		460	---	---	---	---	---	587	12186	91.7					983
		525	---	---	---	---	---	669	12169	92.4					1002
		610	---	---	---	---	---	779	12195	93.3					1022
		720	---	---	---	---	---	916	12149	94.0					1042
53	365	---	---	---	---	---	---	508	13291	89.4	1420	25.1	0.438	1067	
		405	---	---	---	---	---	564	13298	90.3					1089
		425	---	---	---	---	---	592	13302	90.6					1099
		485	---	---	---	---	---	676	13310	91.5					1124
		565	---	---	---	---	---	788	13318	92.5					1150
		665	---	---	---	---	---	928	13318	93.3					1177
54	345	---	---	---	---	---	---	483	13369	90.2	1338	23.3	0.454	997	
		380	---	---	---	---	---	536	13470	91.0					1018
		400	---	---	---	---	---	562	13417	91.3					1027
		455	---	---	---	---	---	641	13453	92.1					1051
		530	---	---	---	---	---	747	13459	93.0					1076
		623	---	---	---	---	---	878	13459	93.8					1102
		---	---	---	---	---	---	726	1023	94.4	1338				

Nota (\*) - VENTILAZIONE SOLO L.O. / FAN ONLY SIDE COMMUTATOR

Nota (°) - Regolazione di campo / Field weakening



Potenza eccitazione Excitation power	(w)	6200	Tipo Size Ventilazione Ventilation	MGL C 500 L IC 06
Cost. tempo eccitaz. Field time constant	(ms)	1240		
Massa del motore Mass of the motor	(Kg)	6720		
Momento d'inerzia rotore Rotor inertia moment	(Kgm2)	82.6		

Avv.	Velocità nominale n/min a tensione nominale di armatura Rated speed (rev/min) at rated voltage							Potenza Power kW	Coppia vel.nomin. Torque at rated speed Nm	Rendimento Efficiency %	Circuito di armatura Armature circuit			Max giri Max. speed (°)	
	400	440	460	520	600	700	810				Corrente Current Amp	Res. 115°C mOhm	Ind. mH		
55	310	---	---	---	---	---	---	446	13739	88.5	1260	31.3	0.560	933	
		340	---	---	---	---	---	495	13903	89.3	1260				953
		360	---	---	---	---	---	520	13793	89.7	1260				962
			410	---	---	---	---	595	13858	90.8	1260				984
		480	---	---	---	---	---	694	13807	91.8	1260				1008
			565	---	---	---	---	819	13842	92.9	1260				1033
		660	---	---	---	---	---	956	13832	93.7	1260				1023
56	300	---	---	---	---	---	---	426	13560	89.6	1188	28.4	0.643	922	
		335	---	---	---	---	---	473	13483	90.5	1188				942
		350	---	---	---	---	---	496	13533	90.8	1188				951
			400	---	---	---	---	567	13536	91.8	1188				974
		470	---	---	---	---	---	660	13410	92.6	1188				999
			553	---	---	---	---	777	13410	93.4	1188				1025
		644	---	---	---	---	---	905	13410	94.0	1188				1063
57	280	---	---	---	---	---	---	382	13028	86.5	1104	42.1	0.769	954	
		315	---	---	---	---	---	425	12884	87.5	1104				978
		330	---	---	---	---	---	447	12935	88.0	1104				988
			375	---	---	---	---	512	13038	89.2	1104				1015
		440	---	---	---	---	---	599	13000	90.4	1104				1044
			520	---	---	---	---	708	13000	91.6	1104				1074
		608	---	---	---	---	---	827	13000	92.5	1104				1094
58	265	---	---	---	---	---	---	358	12901	88.8	1008	36.6	0.669	828	
		290	---	---	---	---	---	398	13106	89.7	1008				847
		305	---	---	---	---	---	418	13087	90.1	1008				856
			350	---	---	---	---	477	13014	91.0	1008				877
		410	---	---	---	---	---	557	12973	92.1	1008				900
			480	---	---	---	---	656	13051	93.0	1008				924
		560	---	---	---	---	---	765	13054	93.7	1008				923
59	250	---	---	---	---	---	---	274	10466	87.8	780	53.1	0.733	942	
		280	---	---	---	---	---	304	10368	88.6	780				968
		295	---	---	---	---	---	320	10359	89.2	780				980
			335	---	---	---	---	366	10433	90.2	780				1011
		395	---	---	---	---	---	427	10323	91.2	780				1043
			465	---	---	---	---	504	10350	92.3	780				1076
		540	---	---	---	---	---	589	10416	93.2	780				1134
60	250	---	---	---	---	---	---	352	13445	87.6	1005	42.4	0.787	924	
		278	---	---	---	---	---	391	13431	88.4	1005				949
		292	---	---	---	---	---	411	13441	88.9	1005				961
			335	---	---	---	---	471	13426	90.1	1005				990
		390	---	---	---	---	---	550	13467	91.2	1005				1021
			460	---	---	---	---	649	13467	92.2	1005				1053
		537	---	---	---	---	---	757	13467	93.0	1005				1128
61	232	---	---	---	---	---	---	320	13171	86.6	924	49.4	1.02	879	
		259	---	---	---	---	---	357	13163	87.8	924				904
		272	---	---	---	---	---	375	13165	88.2	924				916
			310	---	---	---	---	430	13246	89.5	924				944
		365	---	---	---	---	---	503	13160	90.7	924				975
			431	---	---	---	---	594	13160	91.8	924				1007
		503	---	---	---	---	---	694	13160	92.7	924				1107

Nota (\*) - VENTILAZIONE SOLO L.O. / FAN ONLY SIDE COMMUTATOR

Nota (°) - Regolazione di campo / Field weakening





Potenza eccitazione Excitation power	(w)	6200	Tipo Size	MGL C 500 L
Cost. tempo eccitaz. Field time constant	(ms)	1240	Ventilazione Ventilation	IC 06
Massa del motore Mass of the motor	(Kg)	6720		
Momento d'inerzia rotore Rotor inertia moment	(Kgm2)	82.6		

Avv.	Velocità nominale n/min a tensione nominale di armatura Rated speed (rev/min) at rated voltage							Potenza Power kW	Coppia vel.nomin. Torque at rated speed Nm	Rendimento Efficiency %	Circuito di armatura Armature circuit			Max giri Max. speed (°)	
	400	440	460	520	600	700	810				Corrente Current Amp	Res. 115°C mOhm	Ind. mH		
62	219	---	---	---	---	---	---	308	13430	86.5	890	51.6	1.170	852	
		244	---	---	---	---	---	344	13463	87.8					877
		---	256	---	---	---	---	361	13466	88.2					888
		---	---	294	---	---	---	414	13447	89.5					917
		---	---	---	345	---	---	484	13397	90.6					947
		---	---	---	---	407	---	571	13397	91.7					978
		---	---	---	---	---	476	667	13397	92.6					999
63	202	---	---	---	---	---	---	285	13473	84.6	842	64	1.05	870	
		226	---	---	---	---	---	318	13437	85.8					899
		---	238	---	---	---	---	335	13441	86.5					912
		---	---	273	---	---	---	385	13467	87.9					945
		---	---	---	320	---	---	451	13459	89.3					981
		---	---	---	---	379	---	534	13459	90.5					1018
		---	---	---	---	---	443	624	13459	91.6					1108
64	192	---	---	---	---	---	---	270	13429	84.6	798	68.1	1.28	763	
		214	---	---	---	---	---	301	13432	85.7					786
		---	225	---	---	---	---	317	13454	86.4					797
		---	---	259	---	---	---	364	13421	87.7					824
		---	---	---	305	---	---	427	13369	89.2					852
		---	---	---	---	361	---	505	13369	90.5					881
		---	---	---	---	---	422	591	13369	91.5					929
65	181	---	---	---	---	---	---	233	12293	83.7	696	82.9	1.45	873	
		202	---	---	---	---	---	260	12291	84.9					906
		---	213	---	---	---	---	274	12284	85.6					920
		---	---	244	---	---	---	315	12328	87.0					959
		---	---	---	287	---	---	370	12311	88.6					1001
		---	---	---	---	340	---	438	12311	89.9					1045
		---	---	---	---	---	398	513	12311	91.0					1075
66	173	---	---	---	---	---	---	255	14076	83.3	765	78.3	1.28	456	
		194	---	---	---	---	---	285	14029	84.7					464
		---	204	---	---	---	---	300	14043	85.3					467
		---	---	235	---	---	---	345	14019	86.7					476
		---	---	---	276	---	---	406	14047	88.5					484
		---	---	---	---	---	---	---	---	---					---
		---	---	---	---	---	---	---	---	---					---
67	160	---	---	---	---	---	---	238	14205	82.6	720	87.2	1.56	434	
		180	---	---	---	---	---	266	14112	84.0					441
		---	189	---	---	---	---	280	14147	84.5					445
		---	---	218	---	---	---	323	14149	86.3					453
		---	---	---	256	---	---	380	14175	88.0					461
		---	---	---	---	---	---	---	---	---					---
		---	---	---	---	---	---	---	---	---					---
68	149	---	---	---	---	---	---	215	13779	81.8	657	99.4	2.04	416	
		167	---	---	---	---	---	241	13781	83.4					423
		---	176	---	---	---	---	254	13781	84.0					426
		---	---	203	---	---	---	293	13783	85.8					435
		---	---	---	239	---	---	345	13785	87.5					443
		---	---	---	---	284	---	410	13785	89.0					451
		---	---	---	---	---	---	---	---	---					---

Nota (\*) - VENTILAZIONE SOLO L.O. / FAN ONLY SIDE COMMUTATOR

Nota (°) - Regolazione di campo / Field weakening



Potenza eccitazione Excitation power	(w)	7000	Tipo Size	MGL C 500 P
Cost. tempo eccitaz. Field time constant	(ms)	1300		
Massa del motore Mass of the motor	(Kg)	7220	Ventilazione Ventilation	IC 06
Momento d'inerzia rotore Rotor inertia moment	(Kgm2)	92.8		

Avv.	Velocità nominale n/min a tensione nominale di armatura Rated speed (rev/min) at rated voltage							Potenza Power kW	Coppia vel.nomin. Torque at rated speed Nm	Rendimento Efficiency %	Circuito di armatura circuit			Max giri Max. speed (°)	*
	400	440	460	520	600	700	810				Corrente Current Amp	Res. 115°C mOhm	Ind. mH		
41	680	---	---	---	---	---	---	1004	14099	93.8	2676	6.44	0.127	984	*
		745	---	---	---	---	---	1110	14228	94.3	2676			995	*
		780	---	---	---	---	---	1163	14238	94.5	2676			1000	*
42	600	---	---	---	---	---	---	997	15868	93.4	2670	7.2	0.157	919	*
		665	---	---	---	---	---	1102	15825	93.8	2670			929	*
		695	---	---	---	---	---	1155	15870	94.0	2670			934	*
		795	---	---	---	---	---	1313	15771	94.6	2670			945	*
43	525	---	---	---	---	---	---	888	16152	93.4	2376	7.87	0.19	912	*
		580	---	---	---	---	---	982	16168	93.9	2376			923	*
		610	---	---	---	---	---	1029	16109	94.1	2376			928	*
		690	---	---	---	---	---	1170	16192	94.7	2376			940	*
		805	---	---	---	---	---	1357	16097	95.2	2376			953	*
44	495	---	---	---	---	---	---	836	16128	93.1	2244	8.81	0.218	960	*
		550	---	---	---	---	---	925	16060	93.7	2244			973	*
		575	---	---	---	---	---	969	16093	93.9	2244			978	*
		655	---	---	---	---	---	1102	16066	94.4	2244			993	*
		760	---	---	---	---	---	1279	16071	95.0	2244			1008	*
45	470	---	---	---	---	---	---	793	16112	93.1	2130	9.38	0.273	819	*
		520	---	---	---	---	---	878	16124	93.7	2130			829	*
		545	---	---	---	---	---	920	16120	93.9	2130			834	*
		620	---	---	---	---	---	1046	16111	94.4	2130			845	*
		720	---	---	---	---	---	1214	16101	95.0	2130			856	*
46	440	---	---	---	---	---	---	699	15170	91.0	1920	14.4	0.207	963	*
		490	---	---	---	---	---	775	15104	91.7	1920			978	*
		510	---	---	---	---	---	813	15223	92.1	1920			984	*
		585	---	---	---	---	---	926	15116	92.7	1920			1001	*
		680	---	---	---	---	---	1077	15124	93.5	1920			1018	*
		795	---	---	---	---	---	1266	15207	94.2	1920			1195	*
47	410	---	---	---	---	---	---	723	16839	91.5	1976	13.6	0.232	943	*
		450	---	---	---	---	---	801	16998	92.1	1976			957	*
		475	---	---	---	---	---	840	16887	92.4	1976			964	*
		540	---	---	---	---	---	957	16924	93.1	1976			980	*
		630	---	---	---	---	---	1113	16870	93.9	1976			997	*
		740	---	---	---	---	---	1308	16881	94.6	1976			1170	*

Nota (\*) - VENTILAZIONE SOLO L.O. / FAN ONLY SIDE COMMUTATOR

Nota (°) - Regolazione di campo / Field weakening

CEAR S.r.l. - Via Valchiampo,14 - 36050 MONTORSO (Vicenza) - Italy

Telefoni 0039 0444 685505 - 685062 - Fax 0039 0444 686190 - [www.cearmotors.com](http://www.cearmotors.com) - [info@cearmotors.com](mailto:info@cearmotors.com)



Potenza eccitazione Excitation power	(w)	7000	Tipo Size	MGL C 500 P
Cost. tempo eccitaz. Field time constant	(ms)	1300		
Massa del motore Mass of the motor	(Kg)	7220	Ventilazione Ventilation	IC 06
Momento d'inerzia rotore Rotor inertia moment	(Kgm2)	92.8		

Avv.	Velocità nominale n/min a tensione nominale di armatura Rated speed (rev/min) at rated voltage							Potenza Power kW	Coppia vel.nomin. Torque at rated speed Nm	Rendimento Efficiency %	Circuito di armatura Armature circuit			Max giri Max. speed (°)	
	400	440	460	520	600	700	810				Corrente Current Amp	Res. 115°C mOhm	Ind. mH		
48	400	---	---	---	---	---	---	678	16186	91.7	1848	13.7	0.292	899	
		445	---	---	---	---	---	751	16116	92.4	1848				912
		465	---	---	---	---	---	788	16183	92.7	1848				918
		535	---	---	---	---	---	897	16011	93.3	1848				934
		620	---	---	---	---	---	1043	16064	94.1	1848				950
		720	---	---	---	---	---	1211	16065	93.6	1848				972
		---	---	---	---	---	---	---	---	---	---				---
49	385	---	---	---	---	---	---	653	16197	91.8	1779	14.4	0.345	875	
		430	---	---	---	---	---	723	16056	92.4	1779				889
		450	---	---	---	---	---	758	16085	92.6	1779				895
		510	---	---	---	---	---	863	16159	93.3	1779				910
		595	---	---	---	---	---	1004	16113	94.1	1779				927
		699	---	---	---	---	---	1179	16114	94.7	1779				949
		---	---	---	---	---	---	---	---	---	---				---
50	365	---	---	---	---	---	---	612	16011	90.9	1683	17.4	0.315	831	
		400	---	---	---	---	---	678	16186	91.6	1683				845
		420	---	---	---	---	---	711	16166	91.8	1683				851
		480	---	---	---	---	---	811	16134	92.7	1683				866
		560	---	---	---	---	---	944	16097	93.5	1683				882
		658	---	---	---	---	---	1109	16098	94.2	1683				898
		766	---	---	---	---	---	1291	16097	94.7	1683				958
		---	---	---	---	---	---	---	---	---	---				---
51	345	---	---	---	---	---	---	579	16026	90.7	1596	18.9	0.365	784	
		380	---	---	---	---	---	642	16133	91.4	1596				797
		400	---	---	---	---	---	673	16067	91.7	1596				802
		455	---	---	---	---	---	768	16118	92.5	1596				817
		530	---	---	---	---	---	894	16108	93.4	1596				832
		623	---	---	---	---	---	1051	16108	94.1	1596				847
		725	---	---	---	---	---	1223	16108	94.6	1596				907
		---	---	---	---	---	---	---	---	---	---				---
52	330	---	---	---	---	---	---	501	14498	90.0	1392	22.9	0.433	834	
		365	---	---	---	---	---	556	14546	90.8	1392				849
		385	---	---	---	---	---	583	14460	91.0	1392				856
		435	---	---	---	---	---	666	14620	92.0	1392				874
		510	---	---	---	---	---	775	14511	92.8	1392				892
		600	---	---	---	---	---	912	14521	93.6	1392				910
		699	---	---	---	---	---	1063	14532	94.3	1392				943
		---	---	---	---	---	---	---	---	---	---				---
53	300	---	---	---	---	---	---	503	16011	88.6	1420	27.7	0.518	936	
		335	---	---	---	---	---	559	15935	89.5	1420				956
		350	---	---	---	---	---	586	15988	89.7	1420				965
		400	---	---	---	---	---	671	16019	90.9	1420				989
		470	---	---	---	---	---	783	15909	91.9	1420				1014
		555	---	---	---	---	---	923	15881	92.9	1420				1040
		645	---	---	---	---	---	1078	15960	93.7	1420				1064
		---	---	---	---	---	---	---	---	---	---				---
54	284	---	---	---	---	---	---	479	16106	89.5	1338	26.1	0.536	871	
		315	---	---	---	---	---	532	16128	90.4	1338				891
		330	---	---	---	---	---	558	16147	90.7	1338				899
		380	---	---	---	---	---	637	16008	91.6	1338				922
		440	---	---	---	---	---	743	16125	92.6	1338				945
		518	---	---	---	---	---	874	16125	93.4	1338				969
		604	---	---	---	---	---	1019	16125	94.0	1338				996

Nota (\*) - VENTILAZIONE SOLO L.O. / FAN ONLY SIDE COMMUTATOR

Nota (°) - Regolazione di campo / Field weakening

CEAR S.r.l. - Via Valchiampo,14 - 36050 MONTORSO (Vicenza) - Italy

Telefoni 0039 0444 685505 - 685062 - Fax 0039 0444 686190 - www.cearmotors.com - info@cearmotors.com



Potenza eccitazione Excitation power (w)	7000	Tipo Size	MGL C 500 P
Cost. tempo eccitaz. Field time constant (ms)	1300		
Massa del motore Mass of the motor (Kg)	7220	Ventilazione Ventilation	IC 06
Momento d'inerzia rotore Rotor inertia moment (Kgm2)	92.8		

Avv.	Velocità nominale n/min a tensione nominale di armatura Rated speed (rev/min) at rated voltage							Potenza Power kW	Coppia vel.nomin. Torque at rated speed Nm	Rendimento Efficiency %	Circuito di armatura Armature circuit			Max giri Max. speed (°)	
	400	440	460	520	600	700	810				Corrente Current Amp	Res. 115°C mOhm	Ind. mH		
55	255	---	---	---	---	---	---	440	16477	87.3	1260	34.7	0.662	813	
		285	---	---	---	---	---	490	16418	88.4	1260			831	
		295	---	---	---	---	---	---	515	16671	88.9			1260	839
			340	---	---	---	---	---	590	16571	90.0			1260	860
		395	---	---	---	---	---	---	689	16657	91.1			1260	882
			470	---	---	---	---	---	814	16539	92.3			1260	905
				545	---	---	---	---	---	950	16646			93.1	1260
		56	250	---	---	---	---	---	---	422	16119			88.8	1188
277	---			---	---	---	---	469	16168	89.7	1188	821			
291	---			---	---	---	---	---	492	16145	90.0	1188	829		
	335			---	---	---	---	---	563	16049	91.1	1188	851		
390	---			---	---	---	---	---	657	16087	92.2	1188	874		
	459			---	---	---	---	---	774	16087	93.1	1188	898		
				536	---	---	---	---	---	902	16087	93.8	1188	937	
57	230			---	---	---	---	---	---	376	15611	85.1	1104	46.6	0.91
		260	---	---	---	---	---	420	15426	86.5	1104	853			
		270	---	---	---	---	---	---	442	15633	87.0	1104	863		
			310	---	---	---	---	---	507	15618	88.3	1104	888		
		365	---	---	---	---	---	---	594	15541	89.7	1104	915		
			432	---	---	---	---	---	702	15541	90.9	1104	943		
				505	---	---	---	---	---	821	15541	91.9	1104		
		58	220	---	---	---	---	---	---	355	15409	88.0	1008		
240	---			---	---	---	---	394	15677	88.8	1008	735			
255	---			---	---	---	---	---	414	15504	89.3	1008	743		
	290			---	---	---	---	---	474	15608	90.4	1008	763		
340	---			---	---	---	---	---	553	15532	91.4	1008	784		
	400			---	---	---	---	---	653	15589	92.5	1008	806		
				465	---	---	---	---	---	762	15649	93.3	1008	860	
59	210			---	---	---	---	---	---	270	12278	86.5	780	58.9	0.864
		235	---	---	---	---	---	301	12231	87.7	780	842			
		245	---	---	---	---	---	---	316	12317	88.1	780	853		
			280	---	---	---	---	---	362	12346	89.3	780	881		
		330	---	---	---	---	---	---	424	12269	90.6	780	912		
			390	---	---	---	---	---	501	12270	91.7	780	944		
				455	---	---	---	---	---	585	12269	92.5	780		
		60	206	---	---	---	---	---	---	347	16086	86.3	1005		
229	---			---	---	---	---	387	16138	87.5	1005	827			
241	---			---	---	---	---	---	407	16127	88.0	1005	837		
	276			---	---	---	---	---	466	16123	89.2	1005	865		
325	---			---	---	---	---	---	546	16043	90.5	1005	894		
	384			---	---	---	---	---	645	16043	91.7	1005	924		
				449	---	---	---	---	---	754	16043	92.6	1005	964	
61	191			---	---	---	---	---	---	316	15799	85.5	924	55.2	1.2
		213	---	---	---	---	---	353	15826	86.8	924	785			
		224	---	---	---	---	---	---	371	15816	87.3	924	795		
			258	---	---	---	---	---	426	15767	88.7	924	822		
		300	---	---	---	---	---	---	499	15884	90.0	924	850		
			355	---	---	---	---	---	590	15884	91.2	924	879		
				415	---	---	---	---	---	690	15884	92.2	924		

Nota (\*) - VENTILAZIONE SOLO L.O. / FAN ONLY SIDE COMMUTATOR

Nota (°) - Regolazione di campo / Field weakening

CEAR S.r.l. - Via Valchiampo,14 - 36050 MONTORSO (Vicenza) - Italy

Telefoni 0039 0444 685505 - 685062 - Fax 0039 0444 686190 - www.cearmotors.com - info@cearmotors.com



Potenza eccitazione  
Excitation power (w) 7000  
Cost. tempo eccitaz.  
Field time constant (ms) 1300  
Massa del motore  
Mass of the motor (Kg) 7220  
Momento d'inerzia rotore  
Rotor inertia moment (Kgm2) 92.8

Tipo  
Size MGL C 500 P  
Ventilazione  
Ventilation IC 06

Avv.	Velocità nominale n/min a tensione nominale di armatura Rated speed (rev/min) at rated voltage							Potenza Power kW	Coppia vel.nomin. Torque at rated speed Nm	Rendimento Efficiency %	Circuito di armatura Armature circuit			Max giri Max. speed (°)
	400	440	460	520	600	700	810				Corrente Current Amp	Res. 115°C mOhm	Ind. mH	
62	180	---	---	---	---	---	---	304	16128	85.4	890	57.8	1.380	738
		201	---	---	---	---	---	339	16106	86.6	890			761
		---	211	---	---	---	---	357	16157	87.2	890			771
		---	---	243	---	---	---	410	16112	88.6	890			798
		---	---	---	284	---	---	480	16140	89.9	890			826
		---	---	---	---	336	---	568	16140	91.1	890			855
		---	---	---	---	---	393	664	16140	92.1	890			884
		---	---	---	---	---	---	---	---	---	---			---
63	166	---	---	---	---	---	---	280	16107	83.1	842	71.5	1.24	753
		186	---	---	---	---	---	314	16121	84.8	842			780
		---	196	---	---	---	---	330	16078	85.2	842			791
		---	---	225	---	---	---	380	16128	86.8	842			823
		---	---	---	265	---	---	447	16108	88.5	842			856
		---	---	---	---	314	---	530	16108	89.9	842			890
		---	---	---	---	---	368	621	16108	91.0	842			920
		---	---	---	---	---	---	---	---	---	---			---
64	157	---	---	---	---	---	---	265	16118	83.0	798	76.1	1.51	657
		176	---	---	---	---	---	297	16114	84.6	798			679
		---	185	---	---	---	---	313	16156	85.3	798			688
		---	---	213	---	---	---	360	16140	86.8	798			713
		---	---	---	251	---	---	423	16093	88.3	798			739
		---	---	---	---	298	---	501	16093	89.8	798			766
		---	---	---	---	---	349	588	16093	90.9	798			802
		---	---	---	---	---	---	---	---	---	---			---
65	148	---	---	---	---	---	---	229	14776	82.3	696	92.6	1.71	752
		166	---	---	---	---	---	256	14727	83.6	696			782
		---	175	---	---	---	---	270	14733	84.3	696			796
		---	---	201	---	---	---	311	14775	85.9	696			832
		---	---	---	237	---	---	366	14747	87.6	696			870
		---	---	---	---	281	---	434	14747	89.2	696			910
		---	---	---	---	---	330	510	14747	90.4	696			924
		---	---	---	---	---	---	---	---	---	---			---
66	142	---	---	---	---	---	---	250	16812	81.7	765	87.4	1.51	402
		159	---	---	---	---	---	280	16816	83.2	765			409
		---	167	---	---	---	---	295	16869	83.8	765			412
		---	---	193	---	---	---	340	16823	85.5	765			420
		---	---	---	227	---	---	401	16869	87.4	765			429
		---	---	---	---	---	---	---	---	---	---			---
67	131	---	---	---	---	---	---	233	16985	80.9	720	97.4	1.83	381
		147	---	---	---	---	---	261	16955	82.4	720			388
		---	155	---	---	---	---	275	16942	83.0	720			391
		---	---	179	---	---	---	318	16965	84.9	720			399
		---	---	---	211	---	---	375	16972	86.8	720			407
68	122	---	---	---	---	---	---	210	16437	79.9	657	111	2.42	364
		137	---	---	---	---	---	236	16450	81.6	657			371
		---	144	---	---	---	---	249	16512	82.4	657			374
		---	---	167	---	---	---	288	16468	84.3	657			382
		---	---	---	197	---	---	340	16481	86.3	657			390
		---	---	---	---	234	---	405	16481	88.0	657			400

Nota (\*) - VENTILAZIONE SOLO L.O. / FAN ONLY SIDE COMMUTATOR

Nota (°) - Regolazione di campo / Field weakening

CEAR S.r.l. - Via Valchiampo,14 - 36050 MONTORSO (Vicenza) - Italy

Telefoni 0039 0444 685505 - 685062 - Fax 0039 0444 686190 - www.cearmotors.com - info@cearmotors.com



Potenza eccitazione Excitation power	(w)	7700	Tipo Size Ventilazione Ventilation	MGL C 500 X  IC 06
Cost. tempo eccitaz. Field time constant	(ms)	1350		
Massa del motore Mass of the motor	(Kg)	7700		
Momento d'inerzia rotore Rotor inertia moment	(Kgm2)	103		

Avv.	Velocità nominale n/min a tensione nominale di armatura Rated speed (rev/min) at rated voltage							Potenza Power kW	Coppia vel.nomin. Torque at rated speed Nm	Rendimento Efficiency %	Circuito di armatura Armature circuit			Max giri Max. speed (°)		
	400	440	460	520	600	700	810				Corrente Current Amp	Res. 115°C mOhm	Ind. mH			
41	590	---	---	---	---	---	---	1001	16201	93.5	2676	7.06	0.145	888	*	
		650	---	---	---	---	---	1107	16263	94.0	2676				898	*
		680	---	---	---	---	---	1160	16290	94.2	2676				903	*
42	520	---	---	---	---	---	---	992	18217	92.9	2670	7.9	0.179	826	*	
		575	---	---	---	---	---	1097	18218	93.4	2670				836	*
		605	---	---	---	---	---	1150	18152	93.6	2670				841	*
		690	---	---	---	---	---	1308	18102	94.2	2670				852	*
43	455	---	---	---	---	---	---	885	18574	93.1	2376	8.63	0.217	820	*	
		505	---	---	---	---	---	979	18512	93.6	2376				831	*
		530	---	---	---	---	---	1026	18486	93.9	2376				835	*
		600	---	---	---	---	---	1167	18573	94.5	2376				847	*
		695	---	---	---	---	---	1354	18604	95.0	2376				859	*
44	430	---	---	---	---	---	---	833	18499	92.8	2244	9.66	0.249	865	*	
		475	---	---	---	---	---	922	18536	93.4	2244				877	*
		500	---	---	---	---	---	966	18449	93.6	2244				882	*
		565	---	---	---	---	---	1099	18575	94.2	2244				896	*
		660	---	---	---	---	---	1277	18476	94.8	2244				910	*
45	405	---	---	---	---	---	---	790	18627	92.7	2130	10.3	0.312	734	*	
		450	---	---	---	---	---	874	18547	93.3	2130				744	*
		470	---	---	---	---	---	916	18611	93.5	2130				748	*
		535	---	---	---	---	---	1043	18617	94.2	2130				758	*
		625	---	---	---	---	---	1211	18503	94.8	2130				769	*
46	380	---	---	---	---	---	---	695	17465	90.5	1920	15.6	0.235	866	*	
		420	---	---	---	---	---	771	17530	91.3	1920				880	*
		445	---	---	---	---	---	808	17339	91.5	1920				886	*
		505	---	---	---	---	---	922	17435	92.3	1920				901	*
		590	---	---	---	---	---	1073	17367	93.1	1920				918	*
		690	---	---	---	---	---	1262	17466	93.9	1920				1078	*
47	355	---	---	---	---	---	---	719	19341	91.0	1976	14.7	0.265	849	*	
		390	---	---	---	---	---	797	19515	91.7	1976				862	*
		410	---	---	---	---	---	836	19471	92.0	1976				868	*
		470	---	---	---	---	---	953	19363	92.7	1976				883	*
		545	---	---	---	---	---	1106	19379	93.3	1976				899	*
		640	---	---	---	---	---	1306	19473	94.4	1976				1056	*

Nota (\*) - VENTILAZIONE SOLO L.O. / FAN ONLY SIDE COMMUTATOR

Nota (°) - Regolazione di campo / Field weakening



Potenza eccitazione Excitation power	(w)	7700	Tipo Size Ventilazione Ventilation	MGL C 500 X  IC 06
Cost. tempo eccitaz. Field time constant	(ms)	1350		
Massa del motore Mass of the motor	(Kg)	7700		
Momento d'inerzia rotore Rotor inertia moment	(Kgm2)	103		

Avv.	Velocità nominale n/min a tensione nominale di armatura Rated speed (rev/min) at rated voltage							Potenza Power kW	Coppia vel.nomin. Torque at rated speed Nm	Rendimento Efficiency %	Circuito di armatura Armature circuit			Max giri Max. speed (°)	
	400	440	460	520	600	700	810				Corrente Current Amp	Res. 115°C mOhm	Ind. mH		
48	345	---	---	---	---	---	---	675	18683	91.3	1848	15.0	0.333	807	
		385	---	---	---	---	---	748	18553	92.0	1848				
		405	---	---	---	---	---	---	784	18486	92.2				1848
			460	---	---	---	---	---	894	18559	93.0				1848
		535	---	---	---	---	---	---	1040	18563	93.8				1848
			630	---	---	---	---	---	1225	18563	94.7				1848
		49	335	---	---	---	---	---	---	649	18500				91.2
370	---			---	---	---	---	719	18557	91.9	1779				
390	---			---	---	---	---	---	754	18462	92.1	1779			
	445			---	---	---	---	---	860	18455	93.0	1779			
515	---			---	---	---	---	---	1001	18561	93.8	1779			
	605			---	---	---	---	---	1176	18561	94.4	1779			
50	315			---	---	---	---	---	---	607	18401	90.2	1683	19.1	0.358
		345	---	---	---	---	---	674	18656	91.0	1683				
		365	---	---	---	---	---	---	707	18497	91.3	1683			
			415	---	---	---	---	---	807	18569	92.2	1683			
		485	---	---	---	---	---	---	940	18508	93.1	1683			
			570	---	---	---	---	---	1106	18508	93.8	1683			
		664	---	---	---	---	---	1288	18508	94.5	1683				
51	296	---	---	---	---	---	---	575	18550	90.1	1596	20.7	0.416	701	
		330	---	---	---	---	---	638	18462	90.9	1596				
		345	---	---	---	---	---	---	669	18517	91.1				1596
			395	---	---	---	---	---	764	18470	92.1				1596
		460	---	---	---	---	---	---	890	18476	92.9				1596
			541	---	---	---	---	---	1047	18476	93.7				1596
		630	---	---	---	---	---	1220	18476	94.3	1596				
52	285	---	---	---	---	---	---	498	16686	89.4	1392	24.7	0.493	745	
		315	---	---	---	---	---	553	16764	90.3	1392				
		330	---	---	---	---	---	---	580	16784	90.6				1392
			380	---	---	---	---	---	662	16636	91.5				1392
		440	---	---	---	---	---	---	772	16755	92.4				1392
			520	---	---	---	---	---	909	16693	93.3				1392
		605	---	---	---	---	---	1059	16715	93.9	1392				
53	260	---	---	---	---	---	---	498	18291	87.7	1420	29.9	0.591	841	
		290	---	---	---	---	---	554	18243	88.7	1420				
		305	---	---	---	---	---	---	582	18222	89.1				1420
			350	---	---	---	---	---	666	18171	90.2				1420
		410	---	---	---	---	---	---	779	18144	91.4				1420
			480	---	---	---	---	---	920	18303	92.6				1420
		560	---	---	---	---	---	1073	18287	93.3	1420				
54	245	---	---	---	---	---	---	475	18514	88.8	1338	28.6	0.611	781	
		272	---	---	---	---	---	528	18537	89.7	1338				
		286	---	---	---	---	---	---	554	18498	90.0				1338
			325	---	---	---	---	---	634	18629	91.1				1338
		380	---	---	---	---	---	---	739	18571	92.1				1338
			448	---	---	---	---	---	871	18571	92.9				1338
		522	---	---	---	---	---	1015	18571	93.7	1338				

Nota (\*) - VENTILAZIONE SOLO L.O. / FAN ONLY SIDE COMMUTATOR

Nota (°) - Regolazione di campo / Field weakening





Potenza eccitazione Excitation power	(w)	7700	Tipo Size Ventilazione Ventilation	MGL C 500 X  IC 06
Cost. tempo eccitaz. Field time constant	(ms)	1350		
Massa del motore Mass of the motor	(Kg)	7700		
Momento d'inerzia rotore Rotor inertia moment	(Kgm2)	103		

Avv.	Velocità nominale n/min a tensione nominale di armatura Rated speed (rev/min) at rated voltage							Potenza Power kW	Coppia vel.nomin. Torque at rated speed Nm	Rendimento Efficiency %	Circuito di armatura Armature circuit			Max giri Max. speed (°)	
	400	440	460	520	600	700	810				Corrente Current Amp	Res. 115°C mOhm	Ind. mH		
55	220	---	---	---	---	---	---	436	18925	86.5	1260	37.5	0.754	727	
		245	---	---	---	---	---	486	18943	87.7	1260			744	
		255	---	---	---	---	---	---	511	19136	88.2			1260	752
			295	---	---	---	---	---	585	18937	89.3			1260	771
		345	---	---	---	---	---	---	685	18960	90.6			1260	792
			405	---	---	---	---	---	809	19075	91.7			1260	814
		475	---	---	---	---	---	---	946	19018	92.7			1260	831
56	215	---	---	---	---	---	---	418	18566	88.0	1188	34.9	0.867	717	
		239	---	---	---	---	---	465	18579	89.0	1188			735	
		251	---	---	---	---	---	---	488	18566	89.3			1188	743
			288	---	---	---	---	---	559	18535	90.5			1188	763
		335	---	---	---	---	---	---	653	18614	91.6			1188	784
			395	---	---	---	---	---	770	18614	92.6			1188	806
		461	---	---	---	---	---	---	899	18614	93.4			1188	830
57	200	---	---	---	---	---	---	371	17714	84.0	1104	50.7	1.04	744	
		220	---	---	---	---	---	415	18014	85.4	1104			764	
		235	---	---	---	---	---	---	437	17758	86.1			1104	773
			270	---	---	---	---	---	502	17755	87.4			1104	797
		315	---	---	---	---	---	---	589	17856	88.9			1104	822
			375	---	---	---	---	---	698	17775	90.3			1104	848
		440	---	---	---	---	---	---	817	17731	91.4			1104	924
58	185	---	---	---	---	---	---	351	18118	87.1	1008	43.7	0.899	639	
		210	---	---	---	---	---	391	17780	88.2	1008			655	
		220	---	---	---	---	---	---	411	17840	88.6			1008	662
			250	---	---	---	---	---	470	17953	89.7			1008	681
		295	---	---	---	---	---	---	550	17804	90.9			1008	701
			345	---	---	---	---	---	649	17964	92.0			1008	722
		405	---	---	---	---	---	---	758	17873	92.8			1008	749
59	175	---	---	---	---	---	---	267	14570	85.6	780	64.1	0.984	729	
		195	---	---	---	---	---	298	14593	86.8	780			752	
		205	---	---	---	---	---	---	313	14580	87.2			780	762
			235	---	---	---	---	---	359	14588	88.5			780	789
		275	---	---	---	---	---	---	421	14619	90.0			780	817
			322	---	---	---	---	---	498	14769	91.2			780	846
		376	---	---	---	---	---	---	582	14781	92.1			780	846
60	177	---	---	---	---	---	---	343	18505	85.3	1005	51.9	1.06	717	
		197	---	---	---	---	---	383	18565	86.6	1005			739	
		207	---	---	---	---	---	---	403	18591	87.2			1005	749
			238	---	---	---	---	---	462	18537	88.4			1005	775
		279	---	---	---	---	---	---	542	18551	89.9			1005	803
			330	---	---	---	---	---	641	18551	91.1			1005	832
		386	---	---	---	---	---	---	750	18551	92.1			1005	888
61	164	---	---	---	---	---	---	312	18167	84.4	924	60.5	1.37	679	
		183	---	---	---	---	---	348	18159	85.6	924			700	
		193	---	---	---	---	---	---	367	18159	86.3			924	710
			222	---	---	---	---	---	421	18109	87.6			924	735
		260	---	---	---	---	---	---	495	18180	89.3			924	762
			308	---	---	---	---	---	586	18181	90.6			924	790
		360	---	---	---	---	---	---	686	18180	91.7			924	829

Nota (\*) - VENTILAZIONE SOLO L.O. / FAN ONLY SIDE COMMUTATOR

Nota (°) - Regolazione di campo / Field weakening



Potenza eccitazione Excitation power	(w)	7700	Tipo Size MGL C 500 X Ventilazione Ventilation IC 06
Cost. tempo eccitaz. Field time constant	(ms)	1350	
Massa del motore Mass of the motor	(Kg)	7700	
Momento d'inerzia rotore Rotor inertia moment	(Kgm2)	103	

Avv.	Velocità nominale n/min a tensione nominale di armatura Rated speed (rev/min) at rated voltage							Potenza Power kW	Coppia vel.nomin. Torque at rated speed Nm	Rendimento Efficiency %	Circuito di armatura Armature circuit			Max giri Max. speed (°)
	400	440	460	520	600	700	810				Corrente Current Amp	Res. 115°C mOhm	Ind. mH	
62	154	---	---	---	---	---	---	300	18603	84.3	890	63.3	1.57	656
		173	---	---	---	---	---	335	18491	85.5	890			678
		182	---	---	---	---	---	353	18521	86.2	890			688
		209	---	---	---	---	---	406	18550	87.7	890			713
		245	---	---	---	---	---	476	18553	89.1	890			739
		290	---	---	---	---	---	564	18553	90.5	890			766
63	142	---	---	---	---	---	---	276	18561	81.9	842	78.3	1.41	669
		159	---	---	---	---	---	309	18558	83.4	842			695
		168	---	---	---	---	---	326	18530	84.2	842			706
		193	---	---	---	---	---	376	18604	85.9	842			735
		228	---	---	---	---	---	442	18512	87.5	842			767
		271	---	---	---	---	---	525	18512	89.0	842			800
64	134	---	---	---	---	---	---	261	18600	81.8	798	83.4	1.73	583
		151	---	---	---	---	---	292	18466	83.2	798			603
		159	---	---	---	---	---	308	18498	83.9	798			612
		183	---	---	---	---	---	356	18577	85.8	798			635
		216	---	---	---	---	---	419	18524	87.5	798			660
		256	---	---	---	---	---	498	18524	89.1	798			686
65	126	---	---	---	---	---	---	225	17052	80.8	696	101	1.94	666
		142	---	---	---	---	---	252	16947	82.3	696			695
		150	---	---	---	---	---	266	16934	83.1	696			707
		173	---	---	---	---	---	307	16946	84.8	696			741
		204	---	---	---	---	---	362	16945	86.7	696			777
		243	---	---	---	---	---	430	16945	88.3	696			815
66	121	---	---	---	---	---	---	245	19335	80.1	765	95.7	1.72	362
		136	---	---	---	---	---	275	19309	81.7	765			369
		143	---	---	---	---	---	291	19433	82.7	765			372
		166	---	---	---	---	---	336	19329	84.5	765			380
		196	---	---	---	---	---	396	19294	86.3	765			388
		67	112	---	---	---	---	---	---	228	19440			79.2
126	---			---	---	---	---	257	19478	81.1	720	350		
133	---			---	---	---	---	271	19458	81.8	720	353		
154	---			---	---	---	---	314	19471	83.9	720	360		
181	---			---	---	---	---	371	19573	85.9	720	368		
68	104			---	---	---	---	---	---	206	18915	78.4	657	122
		117	---	---	---	---	---	232	18935	80.3	657	333		
		123	---	---	---	---	---	245	19021	81.1	657	336		
		143	---	---	---	---	---	284	18965	83.1	657	343		
		169	---	---	---	---	---	336	18986	85.2	657	351		
		202	---	---	---	---	---	434	20567	94.4	657	405		

Nota (\*) - VENTILAZIONE SOLO L.O. / FAN ONLY SIDE COMMUTATOR

Nota (°) - Regolazione di campo / Field weakening



# MOTORI C.C. SERIE MGLC - D.C. MOTORS SERIES MGLC

Forma costr. IM B3 e derivate - Mounting IM B3 and derived

Protezione IP23S - Protection IP23S

Ventilazione IC06 - Cooling IC06

## MGLC 500

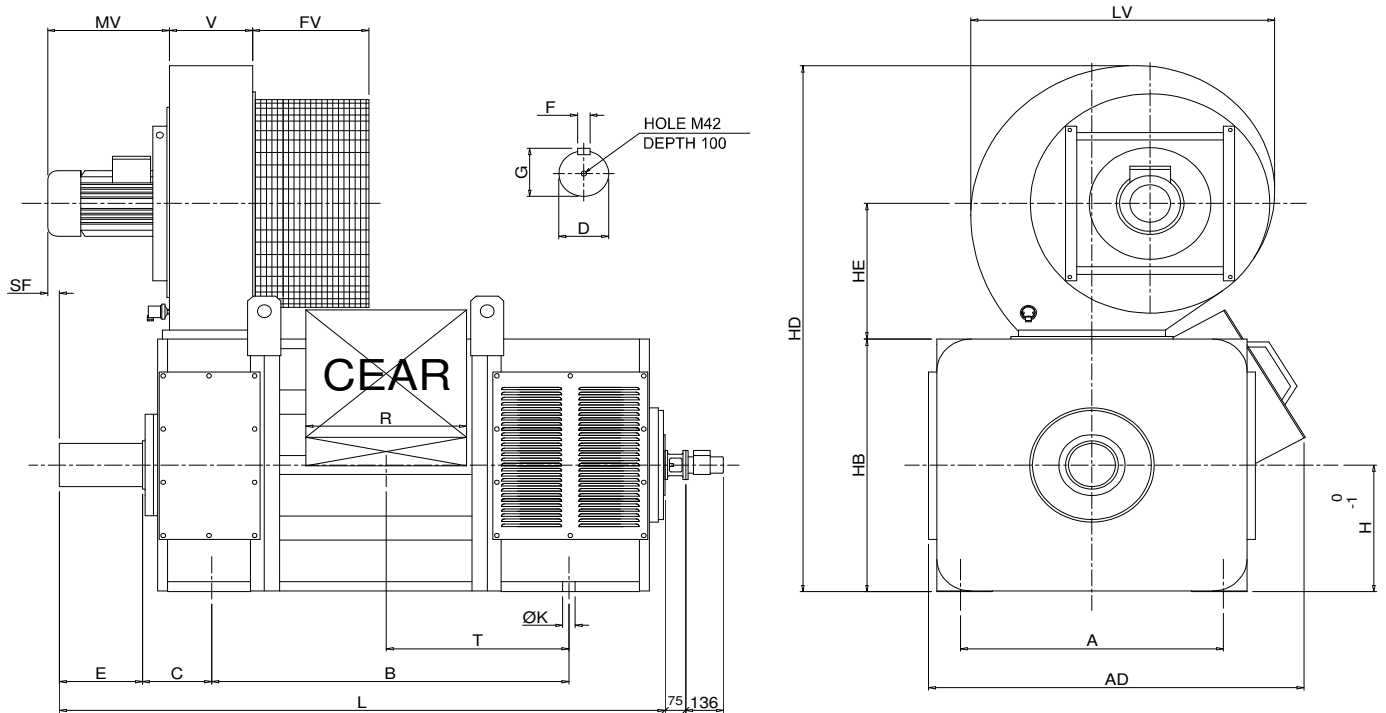

TYPE	SIZE	PIAZZAMENTO					INGOMBRO				ELETTOVENTILATORE					
		A	B	C	H	K	HD	HB	L	AD	FV	MV	V	SF	LV	HE
500	K	950	1060	250	500	45	2076	997	1987	1380	420	440	300	42	1097	535
	S		1120						2047							
	M		1200						2127							
	L		1290						2217							
	P		1400						2327							
	X		1500						2427							

TYPE	SIZE	ALBERO				MORSETTIERA	
		E	D	F	G	R	T
500	K	300	160	40	169	580	660
	S	300	160	40	169	580	660
	M	300	160	40	169	580	660
	L	300	170	40	179	580	660
	P	300	170	40	179	580	660
	X	300	170	40	179	580	660

**TOLLERANZE SU QUOTE DI ACCOPPIAMENTO**

Tables: T1

**TOLERANCE ON CONNECTION QUOTAS**18.05.2007  
Sheet N°

	Dimensioni / Size	Tolleranza Tolerance
TOLLERANZA SU DIAMETRO <b>D</b> DELLA SPORGENZA D'ALBERO	Fino a D = 28 mm Untill D = 28 mm	j6
	Per D = 32 ÷ 48 mm For D = 32 ÷ 48 mm	k6
TOLERANCE ON DIAMETER <b>D</b> OF SHAFT END	Per D superiore a 48 mm For D higher than 48 mm	m6
LINGUETTA TANG	Per tutte For all	h9
FLANGIA B5 E DERIVATE QUOTA <b>N</b> DI CATALOGO	Per N fino a $\varnothing = 230$ mm For N untill $\varnothing = 230$ mm	j6
B5 FLANGE AND DERIVATIVES QUOTA <b>N</b> ON CATALOGUE	Per N oltre a $\varnothing = 230$ mm For N more than $\varnothing = 230$ mm	h6
ALTEZZA D'ASSE <b>H</b> DI CATALOGO	Fino ad H = 250 mm Untill H = 250 mm	0 -0.5
HEIGHT AXIS <b>H</b> ON CATALOGUE	Per H oltre 250 mm For H more than 250 mm	0 -1



PIAZZAMENTO - QUOTE AUSILIARIE

18.05.2007  
Sheet N°

PLACEMENT - AUXILIARY DIMENSION

Tables N°

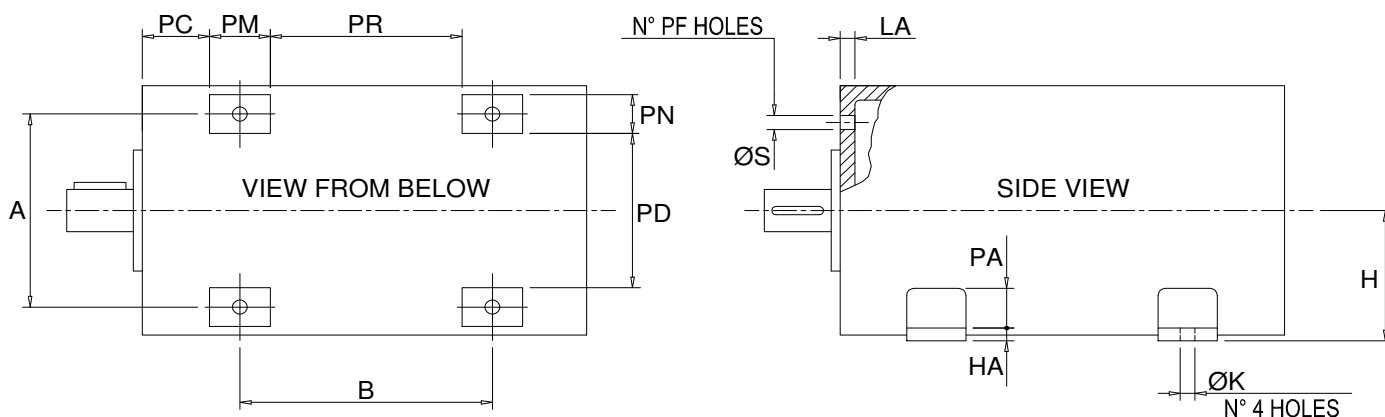

TIPO/TYPER	A	PD	PN	PC	PM	PR	B	K	S	PF	LA	PA	HA	H	
80	S	170	123	36	57	55	100	160	9	11.5	4	16	31	9	80
	M						125	185							
	L						160	220							
100	S	216	150	45	54	65	132	192	12	14	4	20	35	10	100
	M						157	217							
	L						192	252							
112	S	190	146	31	48	52	228	288	12	14	4	16	40	15	112
	M						258	318							
	L						298	358							
132	S	216	172	38	62	55	275	330	12	14	4	20	40	15	132
	M						315	370							
	L						365	420							
160	P	254	200	50	71	75	415	470	14	18	4	25	52	15	160
	K						268	342							
	S						298	372							
180	M	279	225	54	77	80	378	450	14	18	4	30	55	20	180
	L						428	500							
	P						468	540							
200	X	318	222	75	75	100	508	580	18	18	4	30	70	20	200
	K						416	500							
	S						466	550							
250	M	406	316	85	95	140	506	590	24	19	8	38	85	25	250
	L						556	640							
	P						596	680							
315	X	508	390	120	110	160	636	720	28	24	8	45	105	35	315
	X2						676	760							
	K						490	624							
400	S	686	496	152	175	200	540	674	35	24	8	60	140	35	400
	M						590	724							
	L						650	784							
X	P	686	496	152	175	200	720	854	35	24	8	60	140	35	400
	X						760	894							
	X2						800	934							
X	X4	686	496	152	175	200	910	1044	35	24	8	60	140	35	400
	K						550	710							
	S						605	765							
X	M	686	496	152	175	200	670	830	35	24	8	60	140	35	400
	L						750	910							
	P						850	1010							
X	X2	686	496	152	175	200	910	1070	35	24	8	60	140	35	400
	X						980	1140							
	K						595	785							
X	S	686	496	152	175	200	665	855	35	24	8	60	140	35	400
	M						745	935							
	L						845	1035							
X	P	686	496	152	175	200	965	1155	35	24	8	60	140	35	400
	X						1045	1235							



Tabella quote per bocchette di  
adattamento ventilazione separata

Dimensions table of adapted openings  
for separated ventilation

18.05.2007  
Sheet N°

Tables N° 40

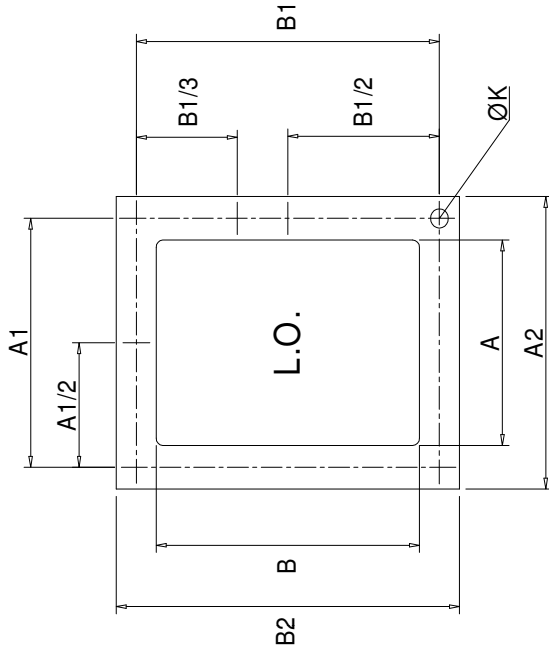

A1/2 = B1/2 = N° 8 FORI  
B1/3 = N° 10 FORI  
A1/2 = B1/2 = N° 8 HOLES  
B1/3 = N° 10 HOLES

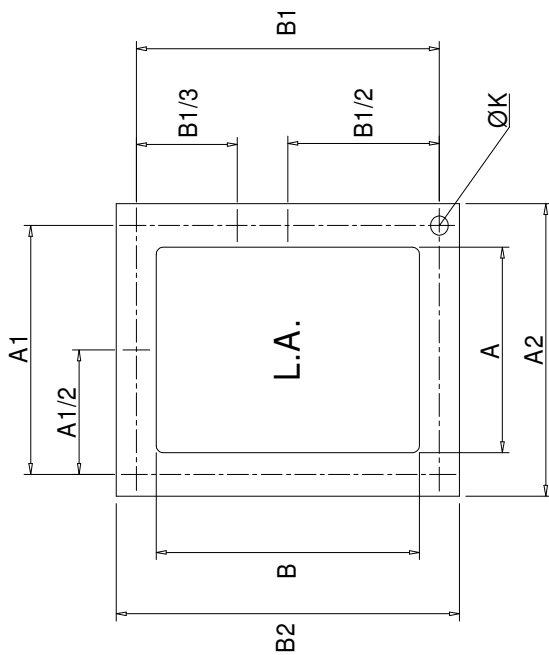

A	B	A1	B1	A2	B2	TIPO
ON TOP / SUPERIORI						
98	145	108	160	120	172	80
ON SIDE / LATERALI						
98	90	108	90	120	105	
ON TOP / SUPERIORI						
100	170	113	178	125	134	100
ON SIDE / LATERALI						
100	120	113	122	125	190	
85	140	98	145	110	155	112
105	180	118	185	130	197	132
115	210	135	220	155	240	160
175	240	195	216	215	256	180
230	250	265	265	285	285	200
260	310	285	335	305	355	250
180		205		225		250 1
355	385	390	405	410	425	315
205		240		260		315 1
410	480	440	504	470	530	400

FORI / HOLES	
N°	K
4	6
4	7
8	7
8	9
10	10

TIPO	A	B	A1	B1	A2	B2
ON TOP / SUPERIORI						
80	90	145	108	160	120	172
ON SIDE / LATERALI						
	90	90	108	90	120	105
ON TOP / SUPERIORI						
100	90	170	113	178	125	190
ON SIDE / LATERALI						
	90	120	113	122	125	134
112	70	140	98	145	110	155
132	90	180	118	185	130	197
160	110	210	135	220	155	240
180	112	240	135	216	155	256
200	130	250	165	265	185	285
250	180	310	205	335	225	355
250 1						
315	205	385	240	405	260	425
315 1						
400	290	480	320	504	350	530

